

236 SSi



# PARTS IDENTIFICATION GUIDE INDEX

## 236 SSi

### 2005 MODEL YEAR

<u>DESCRIPTION</u>	<u>ID. PAGE NO.</u>	<u>DESCRIPTION PAGE NO.</u>
<b>Deck-Overhead View</b> (includes the following) Anchor Lid & Hardware Bow Filler Cushion Option Bow Light Bucket Seating Rails: Bow, Side & Aft Ski Locker Lid & Hardware Starboard & Port Stern Lids Stern Light Swim Platform Cover Transom Door & Hardware Windshield	8	9
<b>Hull/Deck Exterior</b> (includes the following) Bow & Stern Eyes Bow Chafe Option Cleats Docking Light Option Drain Plug Gas Fill/Vent Horn Ladder, Bow & Stern Motor Lid & Hardware Quick & Quiet Option Rubrails & Inserts Ski Eye Thru Hulls Vent Covers	10, 12	11, 13
<b>Graphics</b> (includes the following) 5 Year Warranty Label Boat & Yacht Label Chaparral Lettering & Bird Logo Deck Flares Extended Hull Decal Hull Flares Hull Tapes Model Designator Protected Design Decal Wide Band Gel Coat Option Wide Band Gel Logo Graphics Wide Band Gel Sports Graphics	14, 16	15, 17
<b>Dash/Helm</b> (includes the following) Circuit Breaker Panels Compass Console Tub Cupholders Depth Finder Instrument Panel Shifters & Engine Components Side Panel Woodgrain Starboard Console Steering Options Switch Panels	18	19
<b>Cockpit</b> (Includes the following) Access Door Anchor Locker Components Battery Switch Panels Bilge Breaker Panel Bow Light Bow Seating Cushions Capacity Plates Cockpit Lighting Cockpit Table & Hardware Cupholders	20, 22	21, 23

# PARTS IDENTIFICATION GUIDE INDEX

## 236 SSi

### 2005 MODEL YEAR

<u>DESCRIPTION</u>	<u>ID. PAGE NO.</u>	<u>DESCRIPTION PAGE NO.</u>
<b>Cockpit Cont'd</b> (Includes the following)	20, 22	21, 23
Deck Plates		
Door Stick & Keeper		
Fire Port		
Glove Box Door & Hardware		
Glove Box Frame		
Grab Rails		
Igloo Cooler		
Jump Start Charge Assembly		
Port Console		
Port Console Storage Tub		
Shocks & Brackets		
Side Panel Woodgrain		
Stereo & Components		
Stern Rail Option		
Transom Trim Panel Options		
Wakeboard Tower Components		
Wakeboard Tower Holders		
Walk Thru Door		
Windshield Braces		
<b>Deck Underside</b> (includes the following)	24	25
Base Mounting Rings		
Cockpit Drains		
Cupholders		
Stereo Speakers		
Vent Hoses		
<b>Engine Well/Hull Interior</b> (includes the following)	26	27
Actuator Lift		
Battery Boots		
Battery Trays		
Bilge Pump		
Blower Hoses		
Fire Extinguisher Option		
Float Switch		
Fuel Lines		
Fuel Shut Off Option		
Fuel Tanks		
Motor Lid Storage Drains		
Steering Cable		
<b>Battery Cable Routing</b> (includes the following)	28	29
Battery Cables		
Battery Switch Panels		
Dual Battery Options		
Jump Start Charge Assembly		
<b>Canvas</b> (includes the following)	N/A	31
Aft Curtains		
Bimini Top		
Cockpit Cover		
Connectors		
Mooring Cover		
Shipping Cover		
Side Curtains		
Tonneau Cover		
<b>Bow Seating</b> (includes the following)	32	33
Backrests		
Bow Seating Assembly		
Bucket Seats		
Cushions		
Snap In Carpet		

# PARTS IDENTIFICATION GUIDE INDEX

## 236 SSi

### 2005 MODEL YEAR

<u>DESCRIPTION</u>	<u>ID. PAGE NO.</u>	<u>DESCRIPTION PAGE NO.</u>
<b>Stern Seating</b> (includes the following) Bench Seat Cushions Filler Cushions Motor Box Cushions Sundeck Lid Cushions	34	35
<b>Side Panels</b> (includes the following) Arm Rests Port Side Panel Stbd Side Panel	36	37
<b>Carpet Boards</b> (includes the following) Engine Compartment Storage Boards Engine Well End Cap Fuel Tank Cover Port & Stbd Bulkheads Port & Stbd Close Outs Storage Floor	38, 40	39, 41
<b>Panel Kit</b> (includes the following) Panel Kit Components Panel Kit Diagrams	42, 44-51	43



236 SSi

# PARTS IDENTIFICATION GUIDE

236 SSi  
2005 MODEL YEAR

## Deck - Overhead View

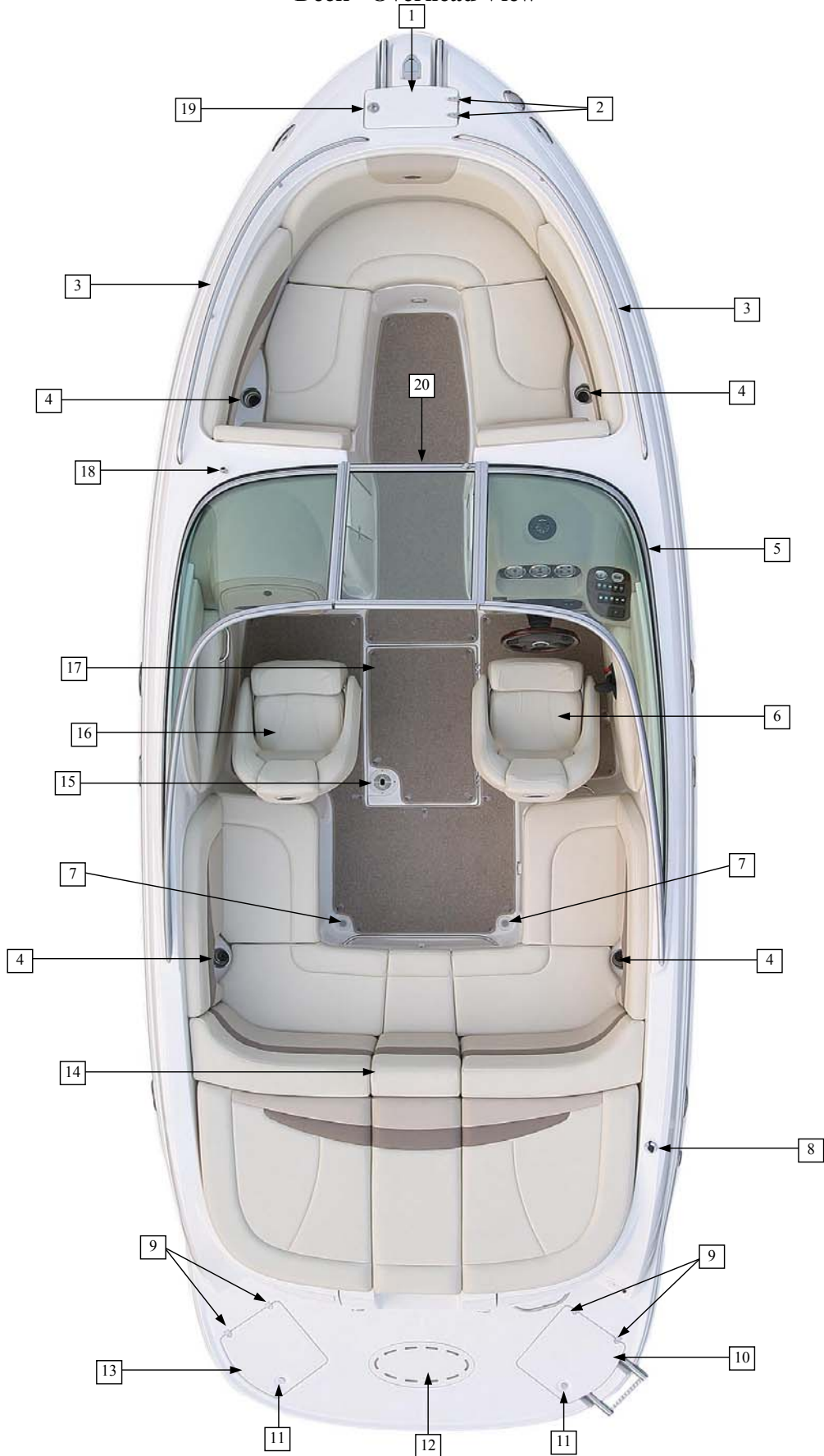



# PARTS IDENTIFICATION GUIDE

## 236 SSI 2005 MODEL YEAR

### Deck - Overhead View

Item No.	Part Number	Description	Qty.	U.O.M.
1	3-1227	256 ANCHOR LID	1	EA
1a	CHAP12-01	8 LB. SAND ANCHOR/ 14.25" HANGER (Option: Custom Anchor)	1	EA
2	66434-1	HINGE STRAP 4 INCH - 94	2	EA
3	35205	RAIL - BOW RAIL 236 - SPLIT 7/8 OVA	1	PR
4	12-00001	CUPHOLDER - STEPPED WELL 304SS W/ N (Option: Premium Pkgs)	6	EA
4a	DS-CHSDSBT	D.S. CUPHOLDER SAND WITH TUBE	6	EA
5	588104000001	WINDSHIELD- PT. STB. WING/FRONT- 25	1	EA
6	31-00011	BUCKET SEAT STBD CHAMPAGNE 2005 (Champagne Interior)	1	EA
6a	31-00009	BUCKET SEAT STBD PLATINUM 2005 (Platinum Interior)	1	EA
6b	3-1238	256SSI STBD LUMBAR SUPPORT	1	EA
6c	75908-30	SEAT - PEDESTAL 8IN. ALUM. ANODIZED	1	EA
7	330-001-CHR	LOCKER VENTILATOR 2 1/2 UN100	2	EA
8	1045-SPL-009-P	ROUND LIGHT BASE PACKARD CONNECTOR/	1	EA
8a	1632SPL054	LIGHT-ALL ROUND 66" OAH W/ 5 DEG. FOR BEND	1	EA
9	2640	1.18 X 1.82 FM HINGE	4	EA
10	3-1265	236SSI STBD STERN LID	1	EA
11	84251	2 IN. HATCH LIFT PIN	2	EA
12	IST58003	256SSI SWIM PLATFORM COVER	1	EA
12a	81930	3 IN. WHITE AIR VENT (Underside of Swim Platform)	2	EA
13	3-1264	236SSI PORT STERN LID	1	EA
14	IST12328	236SSI DROP IN TRANSOM DOOR	1	EA
14a	IST34327	236SSI 3 3/4 TRANSOM DOOR CLEAT	2	EA
15	FDP-4WS	FLOOR DRAIN PULL WHITE	1	EA
16	31-00012	BUCKET SEAT PORT CHAMPAGNE 2005 (Champagne Interior)	1	EA
16a	31-00010	BUCKET SEAT PORT PLATINUM 2005 (Platinum Interior)	1	EA
16b	3-1237	256SSI PORT LUMBAR SUPPORT	1	EA
16c	75908-30	SEAT - PEDESTAL 8IN. ALUM. ANODIZED	1	EA
17	3-1263	236SSI SKI LOCKER LID	1	EA
17a	120402	2X2 FM CAST HINGE	2	EA
17b	350	BUSHING SKI STORAGE	1	EA
18	41-00002	MAGNETIC WINDOW HOLDER SS 20X10 STR	1	EA
19	M1-63-8	LATCH/FLUSH SS(5000 MIN) 10 RELEASE	1	EA
20	588104000105	WINDSHIELD- DOOR & HARDWARE- 256SSI	1	EA
20a	U13778-01	NOTICE SECURE WINDSHIELD DOOR LABEL	1	EA

**Parts Not Pictured Which Are Associated With Deck Overhead:**

Not Pictured	503388T	236SSI OPT BOW FILLER TUBING KIT (Option: Bow Filler Cushions)	1	EA
Not Pictured	IST34035	4 INCH FILLER CUSHION BLOCK (Option: Bow Filler Cushions)	2	KIT

**NOTE: Numbers with letter designations represent parts included with primary numbered part for which there is no photo representation.**



# PARTS IDENTIFICATION GUIDE

236 SSi  
2005 MODEL YEAR

Hull / Deck Exterior



# **PARTS IDENTIFICATION GUIDE**

## **236 SSI** **2005 MODEL YEAR**

### **Hull / Deck Exterior**

<b>Item No.</b>	<b>Part Number</b>	<b>Description</b>	<b>Qty.</b>	<b>U.O.M.</b>
1	STA2416H12	SS INSERT 3/4 X 12	2	EA
2	V21-9659CRA16D	16' CREAM RIGID PVC RUBRAIL	3	EA
3	66516-1	6 IN FLUSH CLEAT-STUD MT. (Option: Premium Pkgs)	6	EA
3a	66009-1	6 INCH CLEAT-HOLLOW BASE	6	EA
4	STA75I114.75	SS INSERT 3/4 X 114 3/4IN	1	EA
5	MI236PORT	INSERT - PRE-BENT PORT 236SSI	1	EA
6	STA75I132	SS INSERT 3/4 x 132 IN	1	EA
7	V21-9659CRA14D	14' CREAM RIGID PVC RUBRAIL	1	EA
8	83937	QUICK/QUIET KIT MERCURY 236SSI (Option: Quick & Quiet Merc 5.0)	1	EA
8a	83938	QUICK/QUIET KIT - 236SSI VOLVO (Option: Quick & Quiet Volvo 5.0)	1	EA
8b	83922-2	QUICK/QUIET KIT-MERC 8.1 W/ 2" SPAC (Option: Quick & Quiet Merc 8.1)	1	EA
8c	83926	VOLVO 8.1 EXHAUST KIT (Option: Quick & Quiet Volvo 8.1)	1	EA
9	72002	3/4 SS SHORT THRU HULL (Motorbox Storage Drains)	2	EA
10	72002	3/4 SS SHORT THRU HULL (Cockpit Liner Drains)	2	EA
11	MI236STARBOARD	INSERT - SS PRE-BENT STBD 236SSI	1	EA
12	540-SPL-004	GAS FILL/VENT(25)	1	EA
12a	U13808-01	SYMBOL FUEL CE LABEL (CE Pkgs)	1	EA
13	72004	1 1/8 SS SHORT THRU HULL (Aft Bilge)	1	EA

#### **Parts Not Pictured Which Are Associated With Hull Deck Exterior:**

Not Pictured	72006	1 1/2 SS SHORT THRU HULL (CE Pkgs)	1	EA
--------------	-------	------------------------------------	---	----

**NOTE: Numbers with letter designations represent parts included with primary numbered part for which there is no photo representation.**



# PARTS IDENTIFICATION GUIDE

236 SSi  
2005 MODEL YEAR

## Hull / Deck Exterior



# PARTS IDENTIFICATION GUIDE

## 236 SSi 2005 MODEL YEAR

### Hull / Deck Exterior

Item No.	Part Number	Description	Qty.	U.O.M.
1	11080	LARGE DROP IN HORN	1	EA
1a	11187	LARGE WHITE HORN GRILL	1	EA
1b	11196	LARGE SS HORN GRILL	1	EA
2	U13772-01	DANGER USING BOARDING LADDER LABEL	2	EA
3	TDL-3XDA	2000-3 STEP DROP LADDER (Bow)	1	EA
4	5852-1	SS DOCKING LIGHT W/PLUG (Option: Premium Pkgs)	1	SET
5	<del>216/220BC</del>	 <del>216/220</del> BOW CHAFE (Option: Premium Pkgs)	1	EA
5a	ALHSW1/2X1.5X5	ANCHOR LINE HANGER	1	EA
5b	BOWSW1001	BOW EYE - 1/2 X 3 7/16 BOW EYE	1	EA
6	81932-C	3IN. GRILL CURVED CHROME	6	EA
7	U17403-01	DANGER USING SKI EYE	1	EA
8	3-1259	236SSI MOTOR BOX LID	1	EA
8a	IST34325	236SSI MOTOR BOX CENTER CUSHION CLE	2	EA
8b	IST34326P	PORT MOTORBOX AFT CENTER CUSHION SL	2	EA
8c	IST34326S	STB MOTORBOX AFT CENTER CUSHION SLI	2	EA
9	075B	STBD VENT COVER - 236SSI	1	EA
10	66240-1	SS CAST HINGE 2.56 X 2.56	2	EA
11	TPL-3XPG	3 STEP LADDER W/ RIVETS (Stem)	1	EA
11a	SC-WTP-SR	WHITE SEAT CLEATS	1	EA
12	66448-1	2.5 INCH FLUSH SKI TOW	1	EA
13	075A	PORT VENT COVER - 236SSI	1	EA

#### Parts Not Pictured Which Are Associated With Hull/Deck Exterior:

Not Pictured	714-1-PLB	DRAIN PLUG	1	EA
Not Pictured	U15925-01	SWIM PLATFORM LABEL	1	EA
Not Pictured	STESW1005	1/2 X 2 STERN EYE 2 BIG PLATES	2	EA
Not Pictured	U16852-01	WINTERIZED LABEL	1	EA

**NOTE: Numbers with letter designations represent parts included with primary numbered part for which there is no photo representation.**

# PARTS IDENTIFICATION GUIDE

236 SSi  
2005 MODEL YEAR

## Graphics



# PARTS IDENTIFICATION GUIDE

## 236 SSi 2005 MODEL YEAR

### Graphics

Item No.	Part Number	Description	Qty.	U.O.M.
1	14-00067	DECAL- 236SSI MODEL DESIGNATOR 1.92	3	EA
1a	QMI-215203	LARGE CHROME DESIGNATOR PLAQUE (Sides Only)	2	EA
2	14-00059	DECAL- BIRD HEAD HULL DECAL- BLUE/CHROME 2.79" X 7.2"	2	EA
2a	14-00052	DECAL- CHROME OVAL PLAQUE 9X3.24- H	2	EA
3	QMI-215201	CHAPARRAL CHROME LETTERS	2	EA
4	14-00074	DECAL - 5YEAR WARRANTY / CSI WINDOW LABEL	1	EA
4a	14-00051	LABEL- BOAT AND YACHT NMMA	1	EA
5	14-00058	DECAL- PROTECTED DESIGN 2004	1	EA
6	U13656-02	EXTENDED V-HULL DECAL BLUE BACK/EMB	1	EA

#### WHITE BOATS W/ CHAMPAGNE INTERIOR

Not Pictured	U13682-05A	GRAPHIC-HULL STRIPE 3/4" GOLD	28.33	FT
Not Pictured	U13685-07	SSI SM. GOLD DECK FLARE LT.GOLD/MAG	1	SET
Not Pictured	U16794-03A	GRAPHIC-SSI SM. HULL GOLD/MAGNESIUM	1	SET

#### WHITE BOATS W/ PLATINUM INTERIOR

Not Pictured	U13682-02A	GRAPHIC-HULL STRIPE 3/4" PEWTER	28.33	FT
Not Pictured	U13685-05	SSI SM. BLK DECK GRAPHIC	1	SET
Not Pictured	U16794-01A	GRAPHIC-SSI SM. BLACK/PEWTER	1	SET

#### BLUE & WHITE W/ CHAMPAGNE INTERIOR

Not Pictured	U13682-05A	GRAPHIC-HULL STRIPE 3/4" GOLD	28.33	FT
Not Pictured	U13685-08	SM. SSI DECK FLARE BL/GLD	1	SET
Not Pictured	U16794-07A	GRAPHIC-SSI SM. HULL FLARE BLUE/GOL	1	SET

#### BLUE & WHITE W/ PLATINUM INTERIOR

Not Pictured	U13682-02A	GRAPHIC-HULL STRIPE 3/4" PEWTER	28.33	FT
Not Pictured	U18575-01	SM. SSI DECK FLARE BLU PEWTER # 616	1	SET
Not Pictured	U16794-04A	GRAPHIC-SSI SM. HULL FLARE BLUE	1	SET

#### EBONY & WHITE W/ CHAMPAGNE INTERIOR

Not Pictured	U13682-05A	GRAPHIC-HULL STRIPE 3/4" GOLD	28.33	FT
Not Pictured	U13685-07	SSI SM. GOLD DECK FLARE LT.GOLD/MAG	1	SET
Not Pictured	U16794-03A	GRAPHIC-SSI SM. HULL GOLD/MAGNESIUM	1	SET

#### EBONY & WHITE W/ PLATINUM INTERIOR

Not Pictured	U13682-02A	GRAPHIC-HULL STRIPE 3/4" PEWTER	28.33	FT
Not Pictured	U13685-05	SSI SM. BLK DECK GRAPHIC	1	SET
Not Pictured	U16794-01A	GRAPHIC-SSI SM. BLACK/PEWTER	1	SET

#### BURGUNDY & WHITE W/ CHAMPAGNE INTERIOR

Not Pictured	U13682-05A	GRAPHIC-HULL STRIPE 3/4" GOLD	28.33	FT
Not Pictured	U13685-10	SM. SSI DECK FLARE BG/GL	1	SET
Not Pictured	U16794-09A	GRAPHIC-SSI HULL FLARE BURG./GOLD	1	SET

#### BURGUNDY & WHITE W/ PLATINUM INTERIOR

Not Pictured	U13682-02A	GRAPHIC-HULL STRIPE 3/4" PEWTER	28.33	FT
Not Pictured	U13685-11	SM. SSI DECK FLARE BG/PTR	1	SET
Not Pictured	U16794-10A	GRAPHIC-SSI SM. HULL FLARE BURG./PE	1	SET

#### YELLOW & WHITE W/ CHAMPAGNE INTERIOR

Not Pictured	U13682-05A	GRAPHIC-HULL STRIPE 3/4" GOLD	28.33	FT
Not Pictured	U13685-09	SM. SSI DECK FLARE YL/GLD	1	SET
Not Pictured	U16794-08A	GRAPHIC-SSI SM. HULL FLARE YELLOW/G	1	SET

#### YELLOW & WHITE W/ PLATINUM INTERIOR

Not Pictured	U13682-02A	GRAPHIC-HULL STRIPE 3/4" PEWTER	28.33	FT
Not Pictured	U13685-06	SM YELLOW DECK GRAPHIC	1	SET
Not Pictured	U16794-06A	GRAPHIC-SSI SM. HULL FLARE YELLOW	1	SET

**NOTE: Numbers with letter designations represent parts included with primary numbered part for which there is no photo representation.**

# PARTS IDENTIFICATION GUIDE

236 SSi  
2005 MODEL YEAR

## Graphics





# PARTS IDENTIFICATION GUIDE

## 236 SSi 2005 MODEL YEAR

### Graphics

Item No.	Part Number	Description	Qty.	U.O.M.
<b>WIDE BAND GEL COAT WHITE BOATS W/ CHAMPAGNE INTERIOR</b>				
1	U13685-07	SSI SM. GOLD DECK FLARE LT.GOLD/MAG	1	SET
2	U19088-02	1 GOLD HULL STRIPE"	42	FT
<b>WIDE BAND GEL COAT WHITE BOATS W/ PLATINUM INTERIOR</b>				
1	U13685-05	SSI SM. BLK DECK GRAPHIC	1	SET
2	U19088-03	1 SILVER HULL STRIPE"	42	FT
<b>WIDE BAND GEL COAT BLACK BOATS W/ CHAMPAGNE INTERIOR</b>				
1	U13685-07	SSI SM. GOLD DECK FLARE LT.GOLD/MAG	1	SET
2	U19088-02	1 GOLD HULL STRIPE"	42	FT
<b>WIDE BAND GEL COAT BLACK BOATS W/ PLATINUM INTERIOR</b>				
1	U13685-05	SSI SM. BLK DECK GRAPHIC	1	SET
2	U19088-03	1 SILVER HULL STRIPE"	42	FT
<b>WIDE BAND GEL COAT BLUE BOATS W/ CHAMPAGNE INTERIOR</b>				
1	U13685-08	SM. SSI DECK FLARE BL/GLD	1	SET
2	U19088-02	1 GOLD HULL STRIPE"	42	FT
<b>WIDE BAND GEL COAT BLUE BOATS W/ PLATINUM INTERIOR</b>				
1	U18575-01	SM. SSI DECK FLARE BLU PEWTER # 616	1	SET
2	U19088-03	1 SILVER HULL STRIPE"	42	FT
<b>WIDE BAND GEL COAT BURGUNDY BOATS W/ CHAMPAGNE INTERIOR</b>				
1	U13685-10	SM. SSI DECK FLARE BG/GL	1	SET
2	U19088-02	1 GOLD HULL STRIPE"	42	FT
<b>WIDE BAND GEL COAT BURGUNDY BOATS W/ PLATINUM INTERIOR</b>				
1	U13685-11	SM. SSI DECK FLARE BG/PTR	1	SET
2	U19088-03	1 SILVER HULL STRIPE"	42	FT
<b>WIDE BAND GEL COAT YELLOW BOATS W/ CHAMPAGNE INTERIOR</b>				
1	U13685-09	SM. SSI DECK FLARE YL/GLD	1	SET
2	U19088-02	1 GOLD HULL STRIPE"	42	FT
<b>WIDE BAND GEL COAT YELLOW BOATS W/ PLATINUM INTERIOR</b>				
1	U13685-06	SM YELLOW DECK GRAPHIC	1	SET
2	U19088-03	1 SILVER HULL STRIPE"	42	FT
<b>WIDE BAND GEL COAT SPORTS GRAPHIC W/ CHAMPAGNE INTERIOR</b>				
3	U19078-01	LG. GOLD CHECK GRAPHIC WIDE BAND GE	1	SET
<b>WIDE BAND GEL COAT SPORTS GRAPHIC W/ PLATINUM INTERIOR</b>				
3	U19078-02	LG. PEWTER CHECK GRAPHIC WIDE BAND	1	SET
<b>WIDE BAND GEL COAT LOGO GRAPHIC W/ CHAMPAGNE INTERIOR</b>				
Not Pictured	U21541-02	GRAPHIC- WAKEBOARD- LARGE GOLD-CHAM	1	SET
<b>WIDE BAND GEL COAT LOGO GRAPHIC W/ PLATINUM INTERIOR</b>				
Not Pictured	U21541-01	GRAPHIC- WAKEBOARD- LARGE	1	SET

**NOTE: Numbers with letter designations represent parts included with primary numbered part for which there is no photo representation.**

# PARTS IDENTIFICATION GUIDE

236 SSi

2005 MODEL YEAR

## Dash/Helm



# PARTS IDENTIFICATION GUIDE

## 236 SSi 2005 MODEL YEAR

### Dash/Helm

Item No.	Part Number	Description	Qty.	U.O.M.
1	205-00217-A	INSTRUMENT PANEL 256SSI	1	EA
2	F-50-C	COMPASS WITH PLUG (Option: Conv Pkgs)	1	EA
3	3-1262	236SSI STBD CONSOLE CHAMPAGNE (Champagne Interior)	1	EA
3a	3-1262G	236SSI STBD CONSOLE PLATINUM (Platinum Interior)	1	EA
4	DS0141	DEPTH FINDER GAUGE (Option: Conv Pkgs)	1	EA
4a	IS0091	DEPTH SOUNDER INSTRUCTION SHEET (Option: Conv Pkgs)	1	EA
4b	BL9134	2" BLANK GAUGE	1	EA
5	205-00298-A	236SSI SWITCH/GA PANEL	1	EA
6	JBLREM25B	BLACK REMOTE	1	EA
7	14-00011	STEERING WHEEL DOME 1.42" (Option: Mahogany Steering Wheel & Conv Pkgs)	1	EA
7a	U15729-02	STEERING WHEEL DOME BLK/BLUE OVAL(E)	1	EA
8	205-00299-A	WIRING - CIRCUIT BREAKER PANEL TAN (Champagne Interior)	1	EA
8a	205-00300-A	WIRING - CIRCUIT BREAKER PANEL GREY (Platinum Interior)	1	EA
9	205-00219-A	STEERING/SWITCH PANEL 256SSI	1	EA
10	MS6073627CB	MAHOGANY STEERING WHEEL (Option: Mahogany Steering Wheel & Conv Pkgs)	1	EA
10a	MS433556/CB	STEERING WHEEL-MODEL 43, TAN (Champagne Interior)	1	EA
10b	MS433557T/CB	STEERING WHEEL-MODEL43,TITANIUM (Platinum Interior)	1	EA
11	61710135251	STEERING WHEEL COVER (Option: Mahogany Steering Wheel & Conv Pkgs)	1	EA
12	883709A03	GEN II SIDE MOUNT SHIFTER (Mercuriser Engines)	1	EA
12a	3858878	CONTROL W/SHUTDOWN SWITCH (Volvo Engines)	1	EA
13	4-1095	215/210/204 SSI SIDE PANEL WOODGRAIN	1	EA
14	3-1231	256/255/236 STBD CONSOLE TUB	1	EA
15	12-00001	CUPHOLDER - STEPPED WELL 304SS W/ N (Option: Premium Pkgs)	6	EA
15a	DS-CHSDSBT	D.S. CUPHOLDER SAND WITH TUBE	6	EA
16	SH91510	SPLINE TILT MECHANISM	1	EA
16a	SH91523	QUICK CONNECT TILT HELM	1	EA

#### Parts Not Pictured Which Are Associated With Dash/Helm:

Not Pictured	P004-1	SPORT BROCHURE (CE Pkgs)	1	EA
Not Pictured	U13780-01	SAFETY ORANGE SYMBOL CE LABEL (CE Pkgs)	1	EA
Not Pictured	123-0120	1/2 FLAME RET.SPLIT COND. (Mercuriser Engines)	16	FT
Not Pictured	14-00069	DECAL - MERCURY IQ CERTIFICATION- C (Mercuriser Engines)	1	EA
Not Pictured	151-0400	4MM PITOT TUBING (Mercuriser Engines)	20	FT
Not Pictured	15768A3	TRIM LIMIT SPACER (Mercuriser Engines)	1	EA
Not Pictured	84-865772A01	CONTROL TRIM HRNS WITH NEW PLUG (Mercuriser Engines)	1	EA
Not Pictured	CC67915	TFXTREME GEN II MERC CABLE (Mercuriser Engines)	1	EA
Not Pictured	CC67916	TFXTREME GEN II MERC CABLE (Mercuriser Engines)	1	EA
Not Pictured	EL3H3M	ELBOW 3/8 MPT X 3/8 HOSE BARB (Mercuriser Engines)	1	EA
Not Pictured	1163871	SPEEDO KIT W/O HOSE (Volvo Engines)	1	EA
Not Pictured	151-0400	4MM PITOT TUBING (Volvo Engines)	22	FT
Not Pictured	2340-840	MIDGET VENT 1 1/2 X 1 3/4 (Volvo Engines)	1	EA
Not Pictured	3588145	TRIM SPACERS (Volvo Engines)	4	EA
Not Pictured	888864	TRIM CYLINDER O RING (Volvo Engines)	0.20	EA
Not Pictured	CC63316	16FT VOLVO EXTREME CABLE (Volvo Engines)	1	EA
Not Pictured	CC63317	17FT VOLVO EXTREME CABLE (Volvo Engines)	1	EA
Not Pictured	U13781-01	CAULK BEFORE INSTALLING LABEL (Volvo Engines)	1	EA
Not Pictured	203-00334-A	WIRING - HARNESS - CORROSION PROTEC (Volvo Engines)	1	EA
Not Pictured	123-0120	1/2 FLAME RET.SPLIT COND. (Volvo OSI Engines)	20	FT
Not Pictured	123-0120	1/2 FLAME RET.SPLIT COND. (Volvo OSI Engines)	1.33	FT
Not Pictured	205-00164	PANEL- NEUTRA SALT SE (Volvo OSI Engines)	1	EA
Not Pictured	IST12314	OSI ENGINES NEUTRA-SALT RESERVOIR B (Volvo OSI Engines)	1	EA

**NOTE: Numbers with letter designations represent parts included with primary numbered part for which there is no photo representation.**

# PARTS IDENTIFICATION GUIDE

236 SSi  
2005 MODEL YEAR

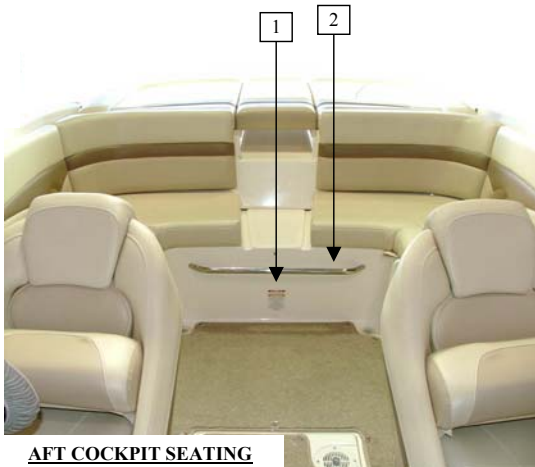

AFT COCKPIT SEATING

## Cockpit



BOW SEATING AREA

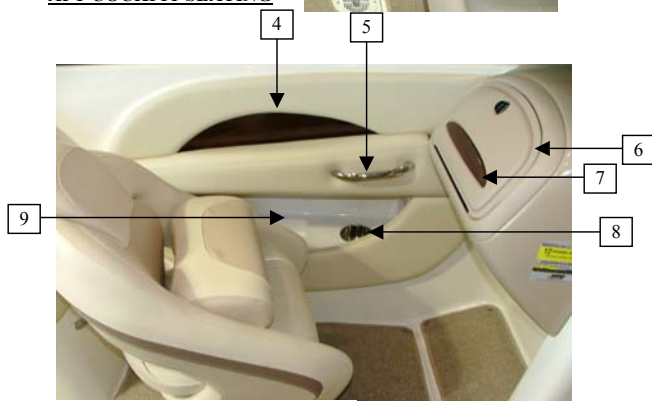

PORT CENTER COCKPIT

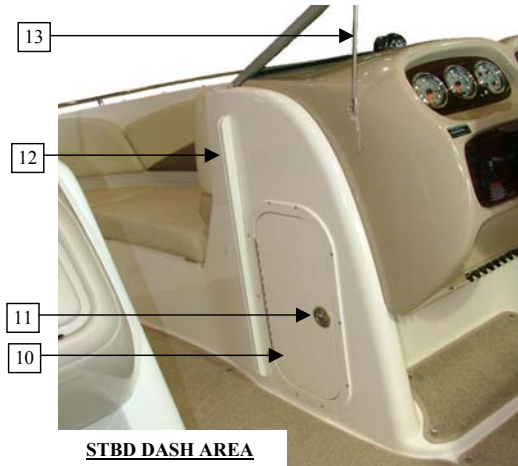

STBD DASH AREA

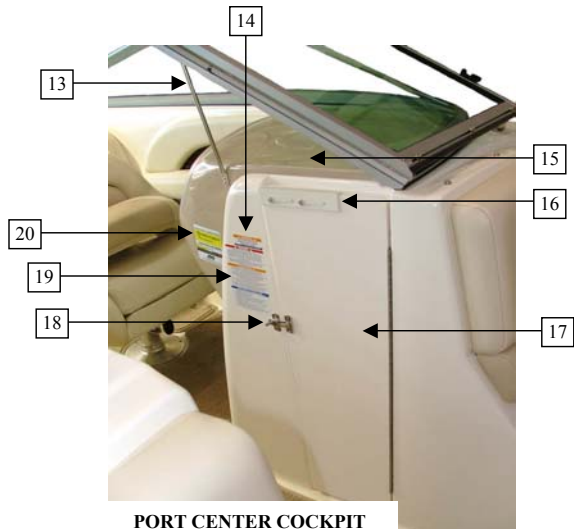

PORT CENTER COCKPIT

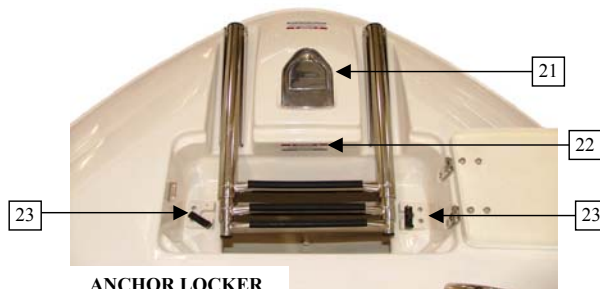

ANCHOR LOCKER

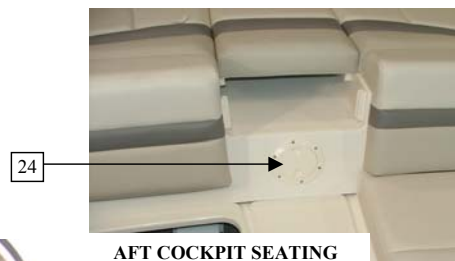

AFT COCKPIT SEATING

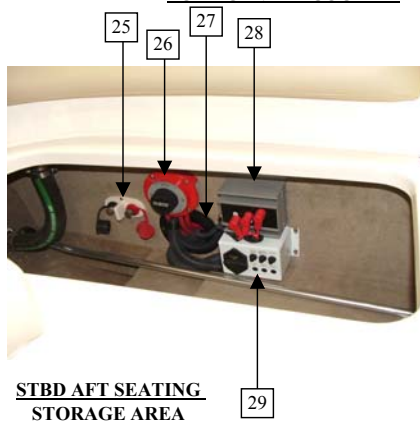

STBD AFT SEATING STORAGE AREA

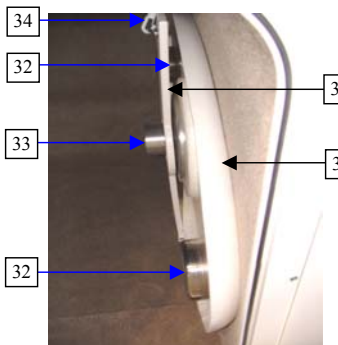

STBD CONSOLE STORAGE AFT BULKHEAD

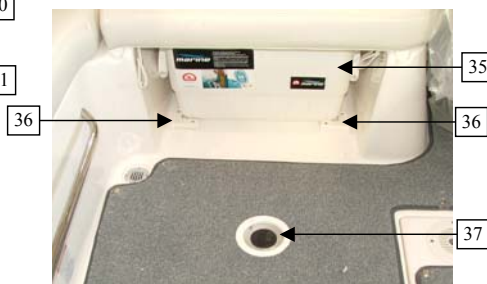

PORT AFT SEATING AREA

# PARTS IDENTIFICATION GUIDE

## 236 SSI 2005 MODEL YEAR

### Cockpit

Item No.	Part Number	Description	Qty.	U.O.M.
1	U17218-01	IN CASE OF FIRE/SECURE ENGINE LIDS	1	EA
2	53130-2	30" GRAB RAIL	1	EA
3	80450SS-ML/A	OBLONG COURTESY LIGHT	1	EA
4	4-1095	215/210/204 SSI SIDE PANEL WOODGRAI	1	EA
5	36-00001	RAIL- 7.375" STUD GRAB RAIL FLARED	3	EA
6	02-00016	GLOVE BOX DOOR 256 2005 LIGHT TAN 2 (Champagne Interior)	1	EA
6a	02-00015	GLOVE BOX FRAME 256 2005 LIGHT TAN (Champagne Interior)	1	EA
6b	02-00018	GLOVE BOX DOOR 256 2005 LIGHT GRAY (Platinum Interior)	1	EA
6c	02-00017	GLOVE BOX FRAME 256 2005 LIGHT GRAY (Platinum Interior)	1	EA
7	14-00062	DECAL- WOODGRAIN PATTERN- 1.652"X13	1	EA
8	12-00001	CUPHOLDER - STEPPED WELL 304SS W/ N (Option: Premium Pkgs)	6	EA
8a	DS-CHSDSBT	D.S. CUPHOLDER SAND WITH TUBE	6	EA
9	3-1228	256/255/236 PORT CONSOLE (SIDE PANEL) TUB	1	EA
10	220500	STBD ACCESS DOOR 13X23.75	1	EA
11	M1-63-8	LATCH/FLUSH SS(5000 MIN) 10 RELEASE	1	EA
12	7243-1	26IN DOOR STICK W/RADIUS	1	EA
13	WB-103	WINDSHIELD BRACE - 236SSI	1	EA
14	U13767-01	WARNING OPEN DOORS MAY CAUSE DAMAGE	1	EA
15	3-1260	236SSI PORT CONSOLE CHAMPAGNE (Champagne Interior)	1	EA
15a	3-1260G	236SSI PORT CONSOLE PLATINUM (Platinum Interior)	1	EA
15b	3-1261	236SSI PORT CONSOLE TUB CHAMPAGNE (Champagne Interior)	1	EA
15c	3-1261G	236SSI PORT CONSOLE TUB PLATINUM (Platinum Interior)	1	EA
16	7163	DOOR KEEPER POWDER COATED WHITE	1	EA
17	IST12327	236SSI WALK THRU DOOR	1	EA
17a	CB12527-06SS	1.25 X 27 .066SS C'SUNK (Walk Thru Door Hinge)	1	EA
18	SSL-70	SHUTTER BAR LATCH	1	EA
19	U17217-01	CO/OPERATOR/BOATMAN COMBO	1	EA
20	14-00077	CAPACITY PLATE - 236SSI	1	EA
20a	14-00071	CONFORMITY PLATE - CANADIAN 236SSI (Canadian Boats Only)	1	EA
20b	14-00075	CAPACITY PLATE - CE 236SSI (CE Pkgs)	1	EA
21	204-M-PS	POP UP SS BOW LIGHT W/CON	1	EA
22	U13770-01	DANGER ANCHOR MAY MOVE LABEL	1	EA
23	100500	ANCHOR RETAINER	2	EA
23a	117090	SLIDING WINDOW LOCK-SS	2	EA
24	DP40-38	1998 4 IN. WHT DECK PLATE (Fire Port)	1	EA
25	JSC-2AW	JUMP START CHARGE ASSY.	1	EA
26	205-00306-A	WIRING - BATTERY SWITCH PANEL - DUAL (Option: Dual Battery)	1	EA
26a	205-00307-A	WIRING - BATTERY SWITCH PANEL - SINGLE	1	EA
27	29-00002	6 X 6 AIR VENT	1	EA
28	93-BI70/2C-A	70AMP 1ALT 2BANK ISOLATOR ORDER INC (Option: Dual Battery)	1	EA
29	205-00106-A	BILGE BREAKER PANEL 216/236SUN/256SSI	1	EA
30	IST12319	TABLE HOLDER TOP	1	EA
31	3-1110CUP	FIBERGLASS COCKPIT TABLE W/ CUP	1	EA
32	12-00002	CUPHOLDER - SHALLOW 304SS (Option: Premium Pkgs)	2	EA
32a	LSS-CHSDAH	S.S. CUPHOLDER SAND	2	EA
33	75354	TABLE BASE	1	EA
34	66105-1	PAD EYE	2	EA
34a	<del>BCORD-14BW</del>	 1/4IN SHOCK CORD	0.25	FT
34b	FPH-2	SMALL HOOKS	2	EA
35	I6776	25QT MARINE COOLER	1	EA
36	IST34015	COOLER RETAINER	2	EA
37	75375-40	FLOOR BASE	1	EA
37a	3381-2403	HOLE PLUG	1	EA

**NOTE: Numbers with letter designations represent parts included with primary numbered part for which there is no photo representation.**

# PARTS IDENTIFICATION GUIDE

236 SSi  
2005 MODEL YEAR

## Cockpit

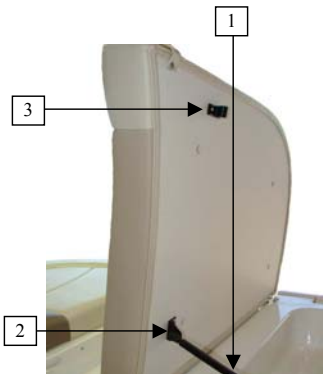

PORT MOTOR LID STORAGE

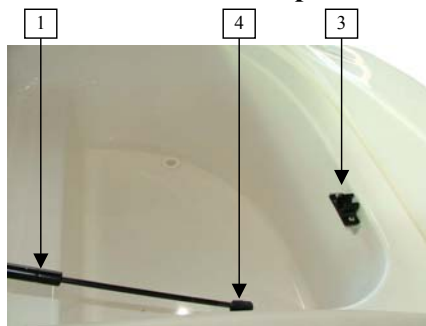

PORT MOTOR LID STORAGE

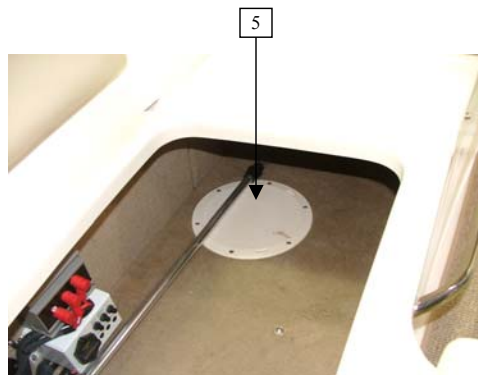

AFT SEATING STORAGE AREA

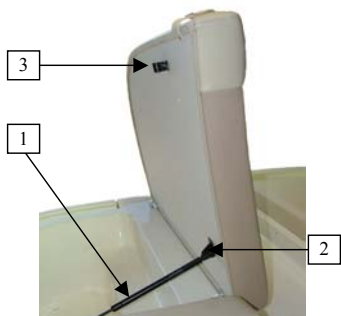

STBD MOTOR LID STORAGE

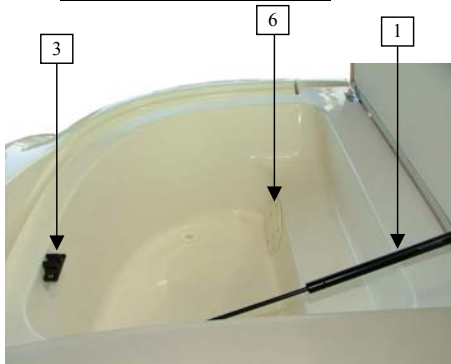

STBD MOTOR LID STORAGE



PORT CENTER COCKPIT

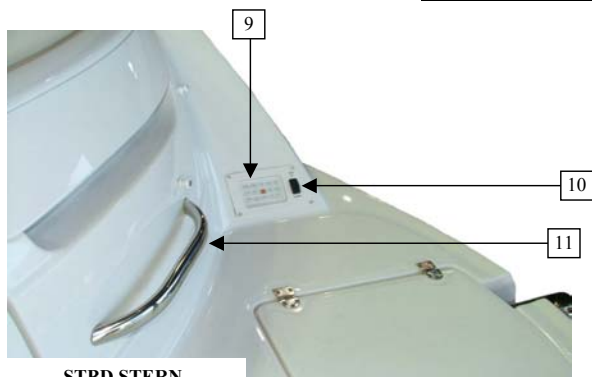

STBD STERN



STBD AFT SEATING

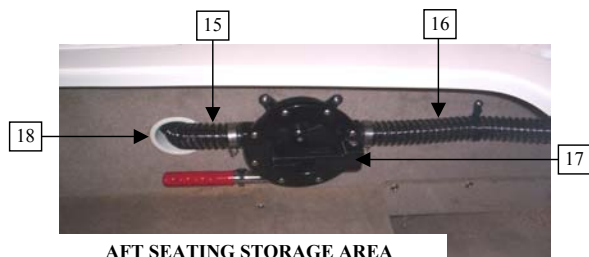

AFT SEATING STORAGE AREA

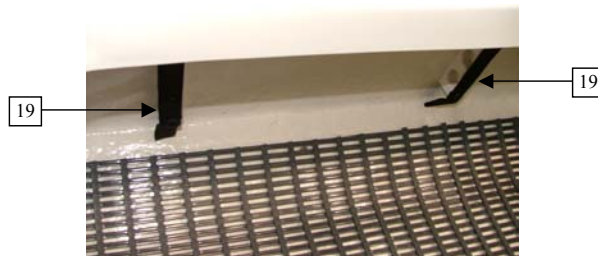

STBD SKI LOCKER BULKHEAD

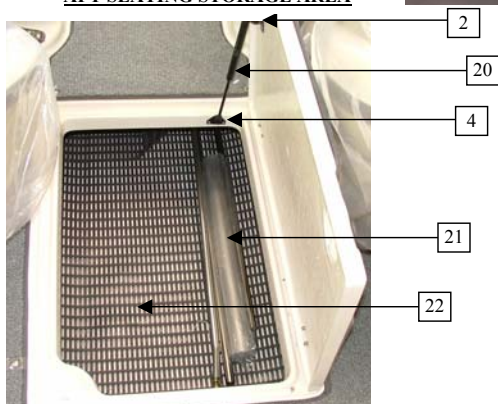

AFT COCKPIT FACING FORWARD



PORT SKI LOCKER BULKHEAD

# PARTS IDENTIFICATION GUIDE

**236 SSI**  
**2005 MODEL YEAR**

## Cockpit

Item No.	Part Number	Description	Qty.	U.O.M.
1	SL34-40-1	40LB GAS SHOCK 20IN X 11.75IN	2	EA
2	SL50BP3-1	90 DEGREE BRACKET-BLACK	3	EA
3	H-9224	ADJ NYLON DOOR HOLDER	2	EA
4	SL40BP3-1	FLAT BRACKET-BLACK	3	EA
5	DP83-38	1998 8 IN. WHT DECK PLATE (Fuel Tank Access)	1	EA
6	DP40-38	1998 4 IN. WHT DECK PLATE (Actuator Pull Pin Access)	1	EA
7	MR-16	JBL STEREO/CD PLAYER	1	EA
7a	SEA-ANT	JVC ANTENNA	1	EA
7b	SEASHROUD	STEREO SHROUD	1	EA
7c	SEATRIMPLATE	STEREO TRIM PLATE	1	EA
8	42-00004	LANYARD - SS WIRE EYELETS 3/64 X 8.	1	EA
9	JBLREMOTE5W	WHITE REMOTE (Option: Premium Pkgs)	1	EA
9a	220-02197-H	15FT.STERO REMOTE HARNESS REPLACES (Option: Premium Pkgs)	1	EA
9b	220-02721-C	Y-REMOTE HARNESS (Option: Premium Pkgs)	1	EA
10	205-00181-A	MERC TRANSOM TRIM PANEL SE (Option: Premium Pkgs W/Merc Engines)	1	EA
10a	205-00182-A	VOLVO SE TRANSOM TRIM PANEL (Option: Premium Pkgs W/Volvo Engines)	1	EA
11	35206	RAIL - GRAB - 236SSI	1	EA
12	36-00001	RAIL- 7.375" STUD GRAB RAIL FLARED	3	EA
13	MS-610BW	JBL SPEAKERS	4	EA
14	80450SS-ML/A	OBLONG COURTESY LIGHT	1	EA
15	141-1120	1 1/2 IN MULTIFLEX-BLACK (CE Pkgs)	3.33	FT
16	141-1120	1 1/2 IN MULTIFLEX-BLACK (CE Pkgs)	6.50	FT
17	954DP2	DIAPHRAGM PUMP W/SS HAND. (CE Pkgs)	1	EA
18	VHF-3WS	3 IN. SAND FLANGE (CE Pkgs)	1	EA
19	IST34209	FILLER CUSHION ROD HOLDER 4 HOLE (Port Ski Locker Bulkhead)	2	EA
19a	INT-STR12S	12 INCH STRAP WITH SNAP	2	EA
20	SL33-40-1	40LB GAS SHOCK 15IN X 9.25IN	1	EA
21	75359-83	27 1/2 LEGS (Stored On Stbd Ski Locker Bulkhead)	1	EA
22	HRA27.5GR-80.5	GRAY HERONAIR 80.5 X 27.5	1	EA
23	CLP-2#	TABLE LEG STORAGE CLIP UN50 (Stbd Ski Locker Bulkhead)	2	EA
24	091025-00	FLEXIBLE PVC ROD HOLDER STD. PACKAG	2	EA

**Parts Not Pictured Which Are Associated With Cockpit:**

Not Pictured	H20-0200	2 INCH BUTT HINGE (Bow Seating Cushions)	4	EA
Not Pictured	247008	WAKEBOARD TOWER - FWD BACKING PLATE (Option: Wakeboard Tower)	2	EA
Not Pictured	247017	WAKEBOARD TOWER - BACKING PLATE - R (Option: Wakeboard Tower)	2	EA
Not Pictured	56-00006	WAKEBOARD TOWER - 210SSI ALUMINUM T (Option: Wakeboard Tower)	1	EA
Not Pictured	56-00009	WAKEBOARD TOWER - HARDWARE 210/204S (Option: Wakeboard Tower)	1	PKG
Not Pictured	262701	WAKEBOARD TOWER- WAKEBOARD HOLDER A (Option: Wakeboard Holders)	2	EA
Not Pictured	35207	RAIL - STERN CUSHION 236SSI (Option: Stern Cushion Rail)	1	SET

**NOTE: Numbers with letter designations represent parts included with primary numbered part for which there is no photo representation.**

# PARTS IDENTIFICATION GUIDE

236 SSi  
2005 MODEL YEAR

## Deck Underside

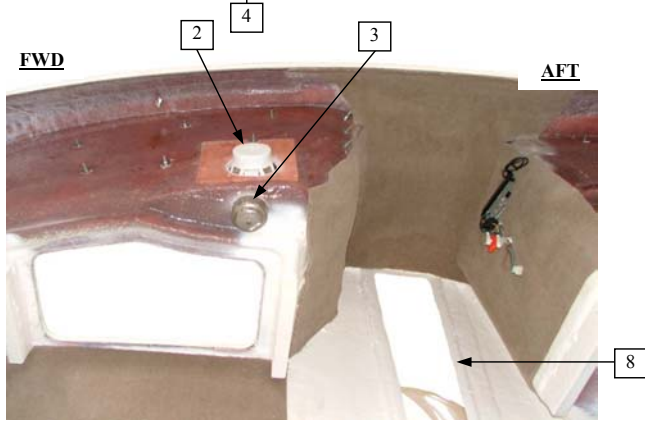
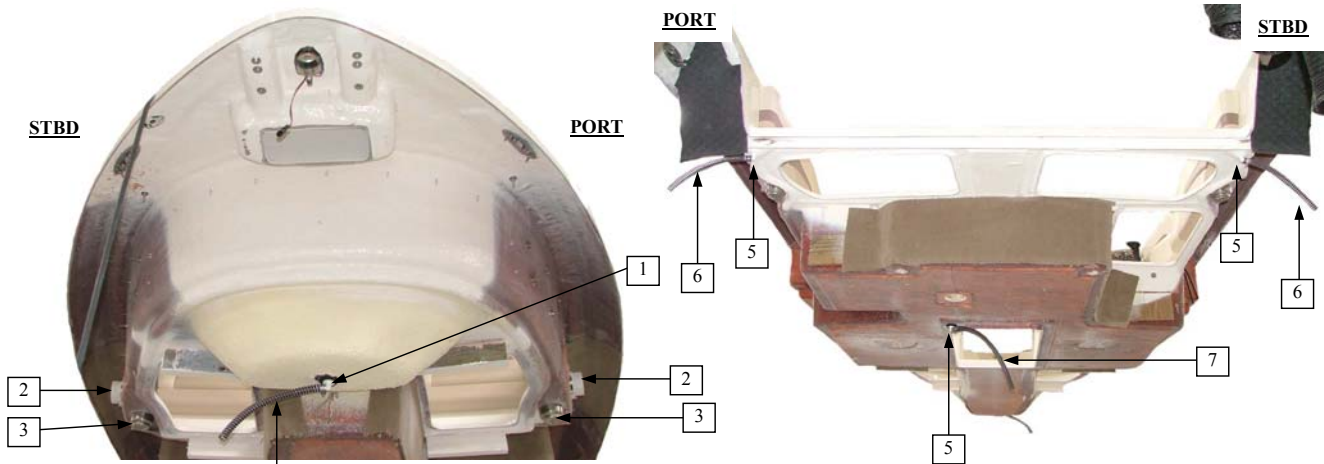

PORT BOW SEATING

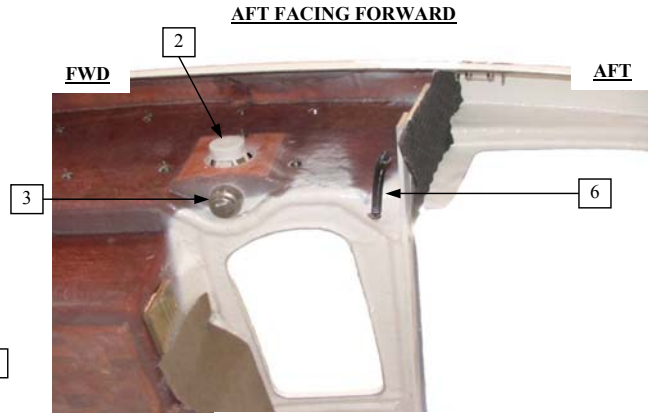

PORT AFT COCKPIT



STBD DASH AREA

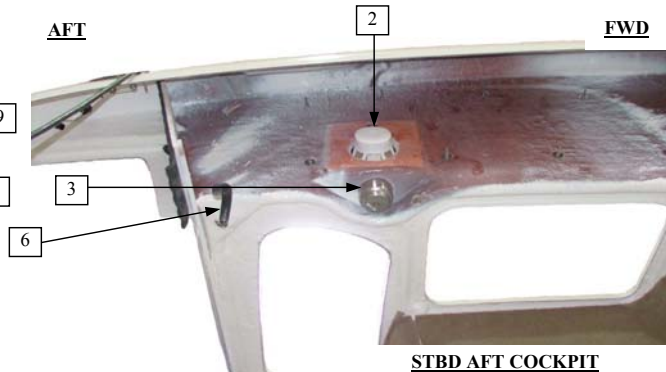

STBD AFT COCKPIT

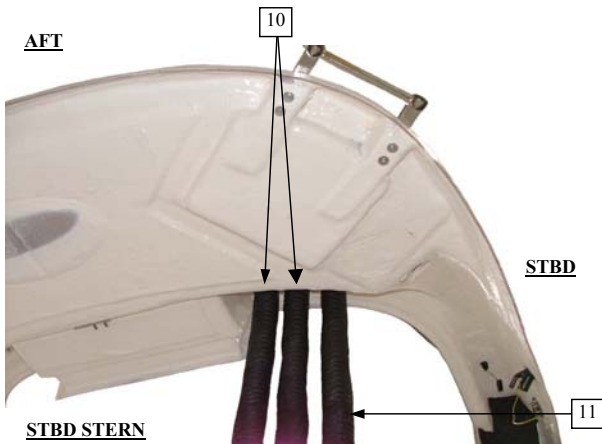

STBD STERN



PORT STERN



# PARTS IDENTIFICATION GUIDE

236 SSi

2005 MODEL YEAR

## Deck Underside

Item No.	Part Number	Description	Qty.	U.O.M.
1	APD-290F	90 DEG. WHITE FLAT DRAIN (Bow Cooler, Motor Lid Storage Drains)	3	EA
1a	PP-118	PUSH PLUG - VINYL (Bow Cooler, Motor Lid Storage Drains)	3	EA
2	MS-610BW	JBL SPEAKERS	4	EA
3	12-00001	CUPHOLDER - STEPPED WELL 304SS W/ N (Option: Premium Pkgs)	6	EA
3a	DS-CHSDSBT	D.S. CUPHOLDER SAND WITH TUBE	6	EA
4	141-0340	3/4 IN. MULTIFLEX (Bow Cooler Drain)	1	FT
5	APD-290	90 DEG. WHITE DRAIN (Port Stern Cooler, Deck Drains, Ski Locker Drain)	4	EA
6	141-0340	3/4 IN. MULTIFLEX (Port & Stbd Deck Drains)	2 @ 1	FT
7	141-0340	3/4 IN. MULTIFLEX (Ski Locker Drain-Drains Into Keel)	1.50	FT
8	100W1X1/4	WHITE TEXTURE TRIM 5000FT PRICE	7	FT
9	123-0120	1/2 FLAME RET.SPLIT COND.	1.50	FT
10	402-3000	3 IN.BLOWER/VENT HOSE-BLK	2 @ 3.50	FT
11	402-3000	3 IN.BLOWER/VENT HOSE-BLK	4	FT
12	141-0340	3/4 IN. MULTIFLEX (Port Stern Cooler Drain-Drains Into Keel)	3.50	FT

### Parts Not Pictured Which Are Associated With Deck Underside:

Not Pictured	75058	BASE MOUNTING RINGS	1	PR
--------------	-------	---------------------	---	----

**NOTE: Numbers with letter designations represent parts included with primary numbered part for which there is no photo representation.**

# PARTS IDENTIFICATION GUIDE

236 SSi  
2005 MODEL YEAR

## Engine Well



AFT COCKPIT FACING INSIDE ENGINE WELL

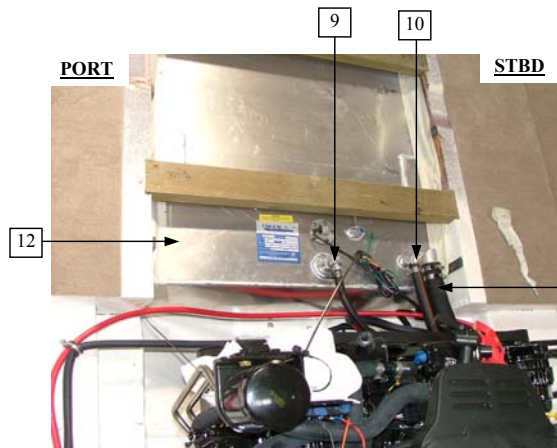

AFT ENGINE WELL FACING FORWARD



AFT ENGINE WELL FACING AFT

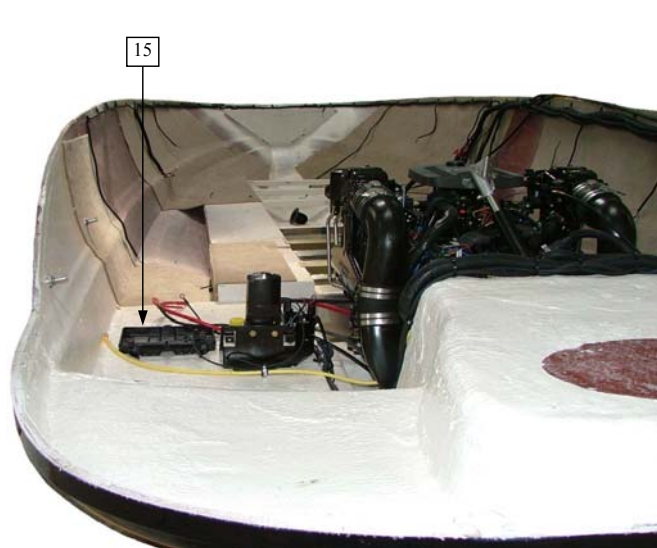

PORT AFT ENGINE WELL FACING FORWARD

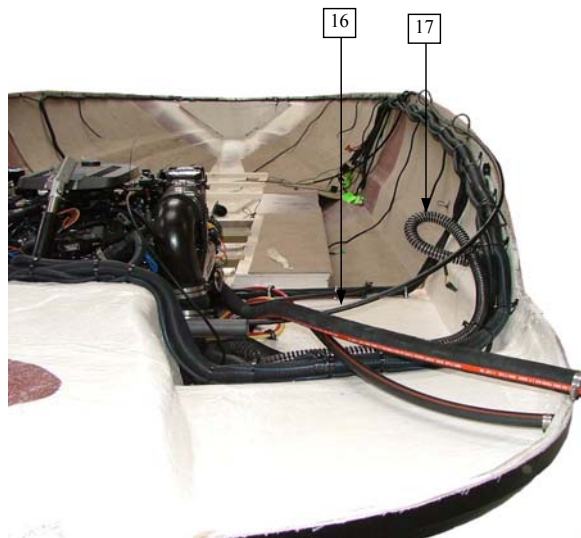

STBD AFT ENGINE WELL FACING FORWARD

# PARTS IDENTIFICATION GUIDE

**236 SSI**  
**2005 MODEL YEAR**

## Engine Well

Item No.	Part Number	Description	Qty.	U.O.M.
1	APD-290F	90 DEG. WHITE FLAT DRAIN (Bow Cooler, Motor Lid Storage Drains)	3	EA
1a	PP-118	PUSH PLUG - VINYL	3	EA
2	100-0340	3/4 HARDWALL WATER HOSE (Motor Lid Storage Drains)	2 @ 2.50	FT
3	U17408-01	LEAKING FUEL DECAL	1	EA
4	228N3V02	SINGLE BATT. BOOT RED	1	EA
4a	228N3V14	SINGLE BATT. BOOT BLACK	1	EA
4b	458N0V02	DUAL BATT. BOOT RED	1	EA
4c	458N0V14	DUAL BATT. BOOT BLACK	1	EA
5	402-3000	3 IN.BLOWER/VENT HOSE-BLK	3.50	FT
6	402-3000	3 IN.BLOWER/VENT HOSE-BLK	2	FT
7	1733P1	3 BLOWER W/ PACKARD PLUG"	2	EA
8	C-7-10.375	ACTUATOR 7 INCH LIFT 236/255/256SSI	1	EA
9	360-0380	3/8 IN. FUEL LINE TYPE A1	3	FT
10	360-0580	5/8 FUEL LINE TYPE A1	6	FT
11	350-1120L	1 1/2IN FUEL FILL HOSE	6	FT
12	31823	TANK - FUEL ALUMINUM 56G 236SSI (Option: Aluminum Fuel Tank)	1	EA
12a	FT5523	TANK - FUEL 236SSI	1	EA
12b	118-CHAP1X10	1/4 X 1 INCH RUBBER (Beneath Fuel Tank)	6 @ 2	FT
12c	118-CHAP1X10	1/4 X 1 INCH RUBBER (Beneath Fuel Tank)	2 @ 1	FT
12d	118-CHAP1X10	1/4 X 1 INCH RUBBER (Beneath Fuel Tank)	6 @ 0.50	FT
13	4201P1	AUTO FLOAT SWITCH W/COVER PACKARD C	1	EA
13a	4212P1	V1250 BILGE PUMP PACKARD PLUG INSTA	1	EA
14	123-0120	1/2 FLAME RET.SPLIT COND.	2	FT
15	9090-1	BATTERY TRAY 12	1	EA
15a	9065-1	BATTERY BOX (CE Pkgs)	1	EA
16	SSC6217	17' STEERING CABLE	1	EA
17	141-1180	1 1/8 IN. MULTIFLEX (Aft Bilge)	9.50	FT

### Parts Not Pictured Which Are Associated With Engine Well:

Not Pictured	100W1X1/4	WHITE TEXTURE TRIM 5000FT PRICE (Fwd Edge of Motor Box Lid)	7.50	FT
Not Pictured	4-0124	ANGLE BRACKET 1X1X1/8-2IN (Engine Compartment Storage Boards)	6	EA
Not Pictured	4-1000	FIRE EXTINGUISHER BRACKET (Option: Fire Extinguisher & Int'l Fire Ext)	1	EA
Not Pictured	CG2-100-FE241	EXTINGUISHER (Option: Fire Extinguisher)	1	EA
Not Pictured	CG2-125-227	HFC227ea FIRE EXTINGUISHER (Option: Int'l Fire Ext)	1	EA
Not Pictured	DBN32	1/4X3/8 BRASS BARB HOSE (Option: Fuel Shut Off)	2	EA
Not Pictured	230-00797-K	99-SINGLE FUEL SHUTOFF KIT (Option: Fuel Shut Off)	1	KIT
Not Pictured	4720K15	FUEL TROL (Option: Fuel Shut Off)	1	EA
Not Pictured	HN0337	17' TRANSDUCER HRNS (Option: Conv Pkgs)	1	EA
Not Pictured	SN1020	THRU HULL TRANSDUCER (Option: Conv Pkgs)	1	EA
Not Pictured	116-200-3340	3 3/4 MARINE EXHAUST HOSE (Option: Quick & Quiet Merc 8.1)	2 @ 0.63	FT
Not Pictured	9090-1	BATTERY TRAY 12 (Option: Dual Battery)	1	EA
Not Pictured	9065-1	BATTERY BOX (Option: Int'l Dual Batt)	1	EA
Not Pictured	4-1013	4 INCH FUEL TANK BRACKET (Option: CE Pkgs & Int'l Dual Batt)	2	EA

**NOTE: Numbers with letter designations represent parts included with primary numbered part for which there is no photo representation.**

# PARTS IDENTIFICATION GUIDE

236 SSi

2005 MODEL YEAR

## Battery Cable Routing

STANDARD BATTERY CABLE ROUTING

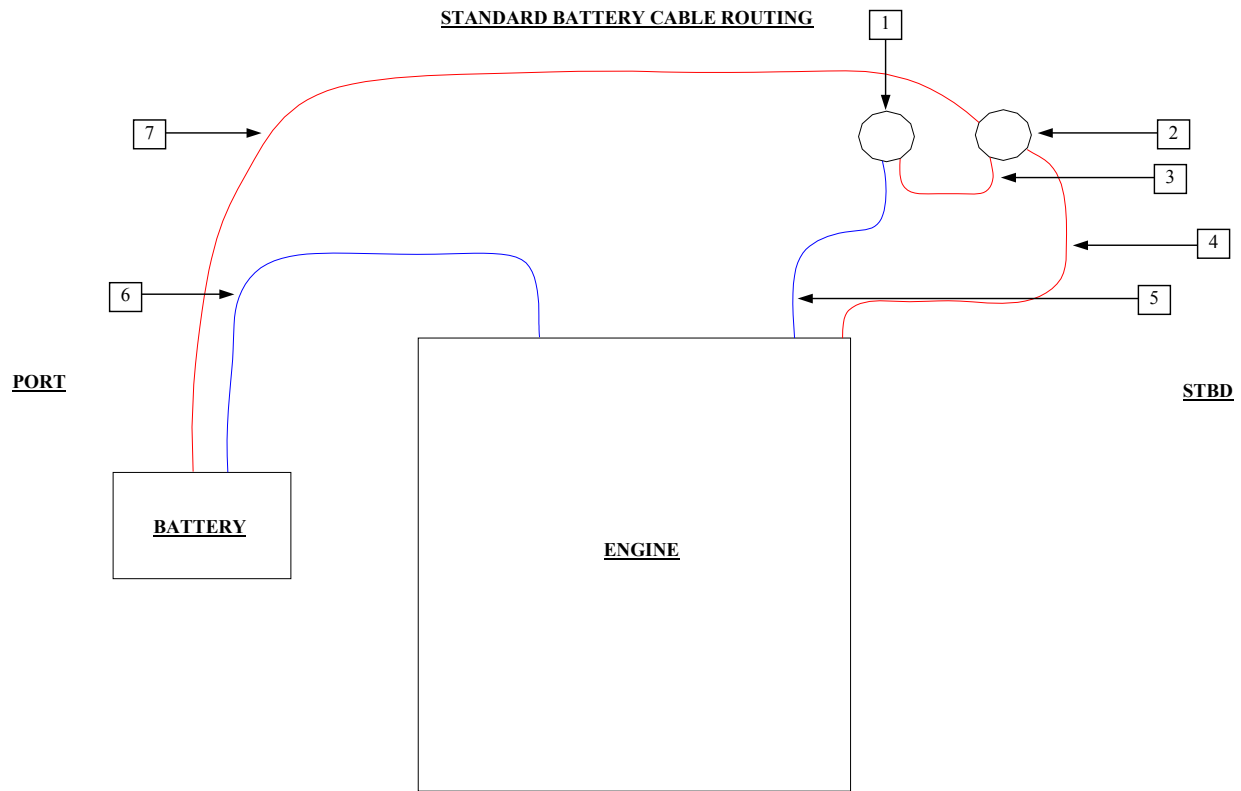

DUAL BATTERY OPTION

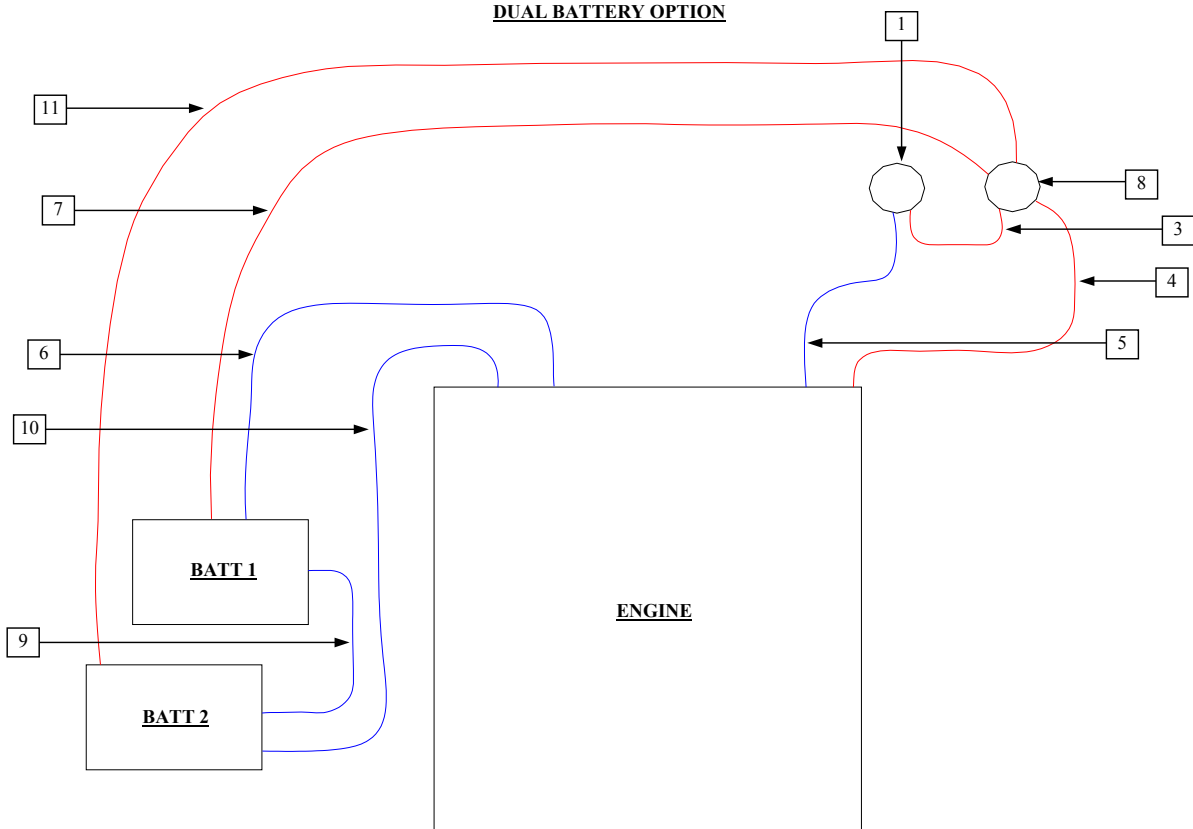

# PARTS IDENTIFICATION GUIDE

236 SSi

2005 MODEL YEAR

## Battery Cable Routing

Item No.	Part Number	Description	Qty.	U.O.M.
1	JSC-2AW	JUMP START CHARGE ASSY.	1	EA
2	205-00307-A	WIRING - BATTERY SWITCH PANEL - SINGLE	1	EA
3	20-018-R2	18IN POSITIVE BATT.CABLE 2GA RED (On/Off Switch To Jump Start)	1	EA
4	20-048-R2	48IN POSITIVE BATT.CABLE 2GA RED (Motor To On/Off Switch)	1	EA
5	20-060-Y2	60IN GROUND BATTERY CABLE 2GA YELLO (Motor To Jump Start)	1	EA
6	20-048-Y2	48IN GROUND BATTERY CABLE 2GA YELLO (Motor To Batt)	1	EA
7	20-096-RO	96IN 1/0 POSITIVE BATTERY CABLE RED (On/Off Switch To Batt)	1	EA
8	205-00306-A	WIRING - BATTERY SWITCH PANEL - DUAL (Option: Dual Battery * Int'l Dual Batt)	1	EA
9	20-018-Y2	18IN GROUND BATTERY CABLE 2GA YELLO (Option: Dual Battery & Int'l Dual Batt)	1	EA
10	20-048-Y2	48IN GROUND BATTERY CABLE 2GA YELLO (Option: Dual Battery & Int'l Dual Batt)	1	EA
11	20-084-RO	84IN 1/0 POSITIVE BATTERY CABLE RED (Option: Dual Battery & Int'l Dual Batt)	1	EA

### Parts Not Pictured Which Are Associated With Engine Well:

Not Pictured	LABEL-BATT1	BATT1 BATTERY CABLE LABEL (Option: Dual Battery & Int'l Dual Batt)	2	EA
Not Pictured	LABEL-BATT2	BATT2 BATTERY CABLE LABEL (Option: Dual Battery & Int'l Dual Batt)	2	EA
Not Pictured	228N3V02	SINGLE BATT. BOOT RED (Option: Dual Battery & Int'l Dual Batt)	1	EA
Not Pictured	458N0V02	DUAL BATT. BOOT RED (Option: Dual Battery & Int'l Dual Batt)	1	EA
Not Pictured	458N0V14	DUAL BATT. BOOT BLACK (Option: Dual Battery & Int'l Dual Batt)	1	EA
Not Pictured	600N7V14	DUAL POST BATTERY BLACK (Option: Dual Battery & Int'l Dual Batt)	1	EA

**NOTE: Numbers with letter designations represent parts included with primary numbered part for which there is no photo representation.**



# PARTS IDENTIFICATION GUIDE

## 236 SSI 2005 MODEL YEAR

### Canvas

Part Number	Description	Qty.	U.O.M.
62944500161	236SSI SHIPPING COVER	1	EA
104535---	BIMINI TOP KIT 236SSI	1	EA
104540---	CONNECTOR 236SSI	1	EA

#### WAKEBOARD TOWER:

<del>5971</del> ---041	 BIMINI TOP W/BOOT TOWER	1	EA
62824500161	SHIPPING COVER TOWER W/ARCH	1	EA

#### MOORING COVER:

62940115151	MOORING COVER 236SSI	1	EA
-------------	----------------------	---	----

#### COCKPIT/BOW COVER:

104543---	TONNEAU COVER 236SSI	1	EA
104544---	COCKPIT COVER 236SSI	1	EA

#### COCKPIT & BOW COVER W/WAKEBOARD TOWER:

<del>5971</del> ---022	210SSI TONNEAU COVER	1	EA
<del>6282</del> ---061	COCKPIT COVER TOWER W/ARCH	1	EA

#### CANVAS PACK:

104541---	SIDE CURTAIN 236SSI	1	SET
104542---	AFT CURTAIN 236SSI	1	EA
104543---	TONNEAU COVER 236SSI	1	EA

#### COCKPIT COVER:

104544---	COCKPIT COVER 236SSI	1	EA
-----------	----------------------	---	----

#### COCKPIT COVER W/WAKEBOARD TOWER:

<del>6282</del> ---061	 COCKPIT COVER TOWER W/ARCH	1	EA
------------------------	--	---	----

**Note:** To identify canvas color selections place the width & color designations below into the spaces provided in the part numbers.

002 - Yellow  
008 - Black  
020 - Beige  
031 - Burgundy  
522 - Blue

#### For Wakeboard Tower Canvas:

0002 - Yellow  
0008 - Black  
0020 - Beige  
0031 - Burgundy  
3000 - Blue



# PARTS IDENTIFICATION GUIDE

236 SSi  
2005 MODEL YEAR  
BOW SEATING

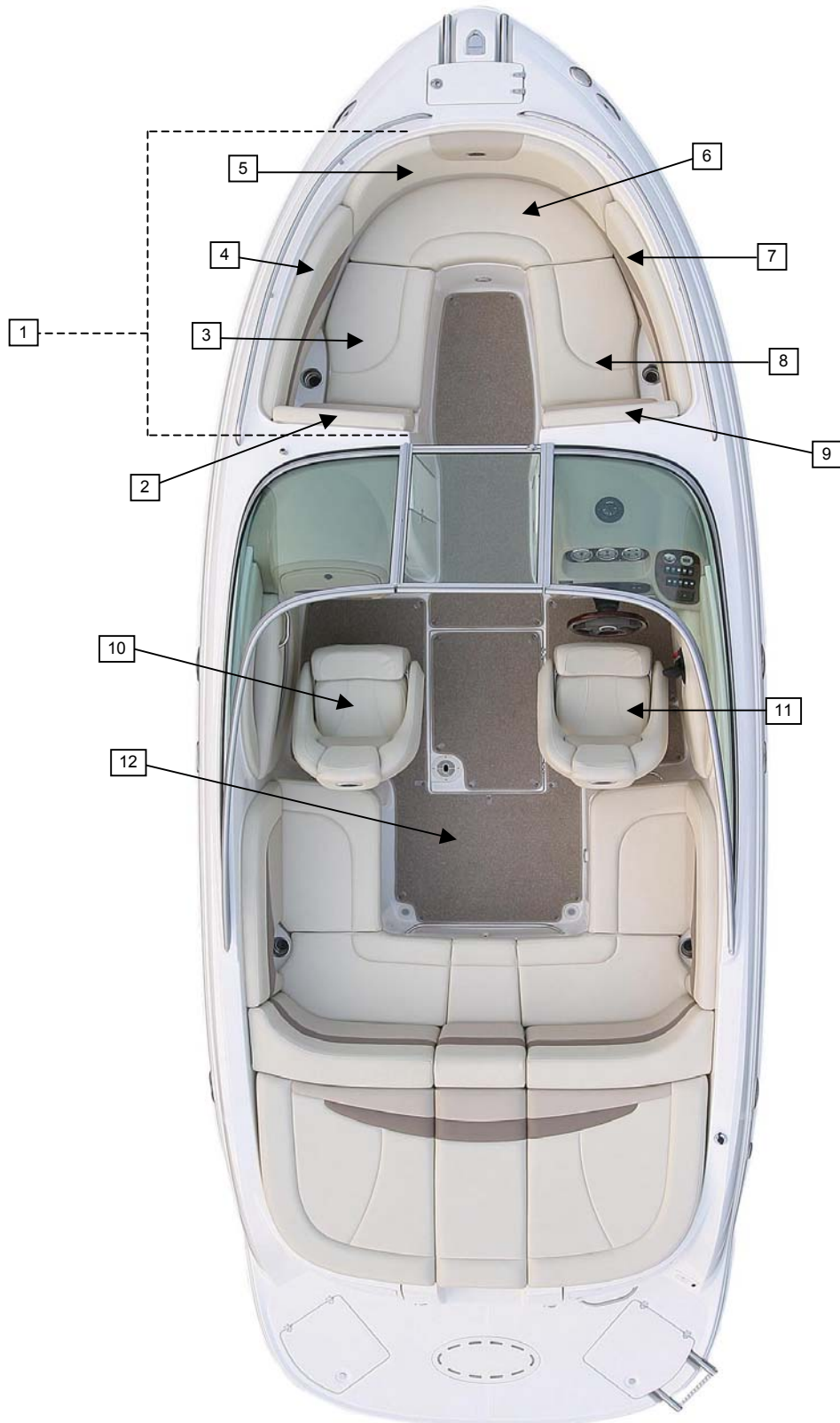



# PARTS IDENTIFICATION GUIDE

## 236 SSI 2005 MODEL YEAR

### BOW SEATING

Item No.	Part Number	Description	Qty.	U.O.M.
1	503346INT	Bow Seating Assembly	1	ea
1a	503346INT-S	Bow Seating Assembly Skin	1	ea
2	503354INT	Port Bow Rear Upper Backrest	1	ea
2a	503354INT-S	Port Bow Rear Upper Backrest Skin	1	ea
2b	503355INT	Port Bow Rear Lower Backrest	1	ea
2c	503355INT-S	Port Bow Rear Lower Backrest Skin	1	ea
3	503347INT	Port Bow Cushion	1	ea
3a	503347INT-S	Port Bow Cushion Skin	1	ea
4	503352INT	Port Bow Wrap	1	ea
4a	503352INT-S	Port Bow Wrap Skin	1	ea
5	503351INT	Center Bow Wrap	1	ea
5a	503351INT-S	Center Bow Wrap Skin	1	ea
6	503348INT	Center Bow Cushion	1	ea
6a	503348INT-S	Center Bow Cushion Skin	1	ea
7	503353INT	Starboard Bow Wrap	1	ea
7a	503353INT-S	Starboard Bow Wrap Skin	1	ea
8	503349INT	Starboard Bow Cushion	1	ea
8a	503349INT-S	Starboard Bow Cushion Skin	1	ea
9	503356INT	Starboard Bow Rear Upper Backrest	1	ea
9a	503356INT-S	Starboard Bow Rear Upper Backrest Skin	1	ea
9b	503357INT	Starboard Bow Rear Lower Backrest	1	ea
9c	503357INT-S	Starboard Bow Rear Lower Backrest Skin	1	ea
10	31-00010	Bucket Seat Port Platinum	1	ea
10a	31-00012	Bucket Seat Port Champagne	1	ea
11	31-00009	Bucket Seat STB. Platinum	1	ea
11a	31-00011	Bucket Seat STB. Champagne	1	ea
12	503455SNC	Optional Snap In Carpet	1	ea
not pictured	503350OPT	Optional Bow Filler Cushion	1	ea
not pictured	503350OPT-S	Optional Bow Filler Cushion Skin	1	ea
not pictured	503388T	Optional Bow Tubing Kit	1	ea
not pictured	503450SNC	Glove Box Carpet	1	ea

*For part numbers with an "INT", "OPT" or "SNC" suffix,  
add "-901" extension for a CHAMPAGNE boat; "-902" for PLATINUM boat.*

**NOTE: Numbers with letter designations represent parts included with  
primary numbered part for which there is no photo representation.**

# PARTS IDENTIFICATION GUIDE

236 SSi  
2005 MODEL YEAR  
STERN SEATING

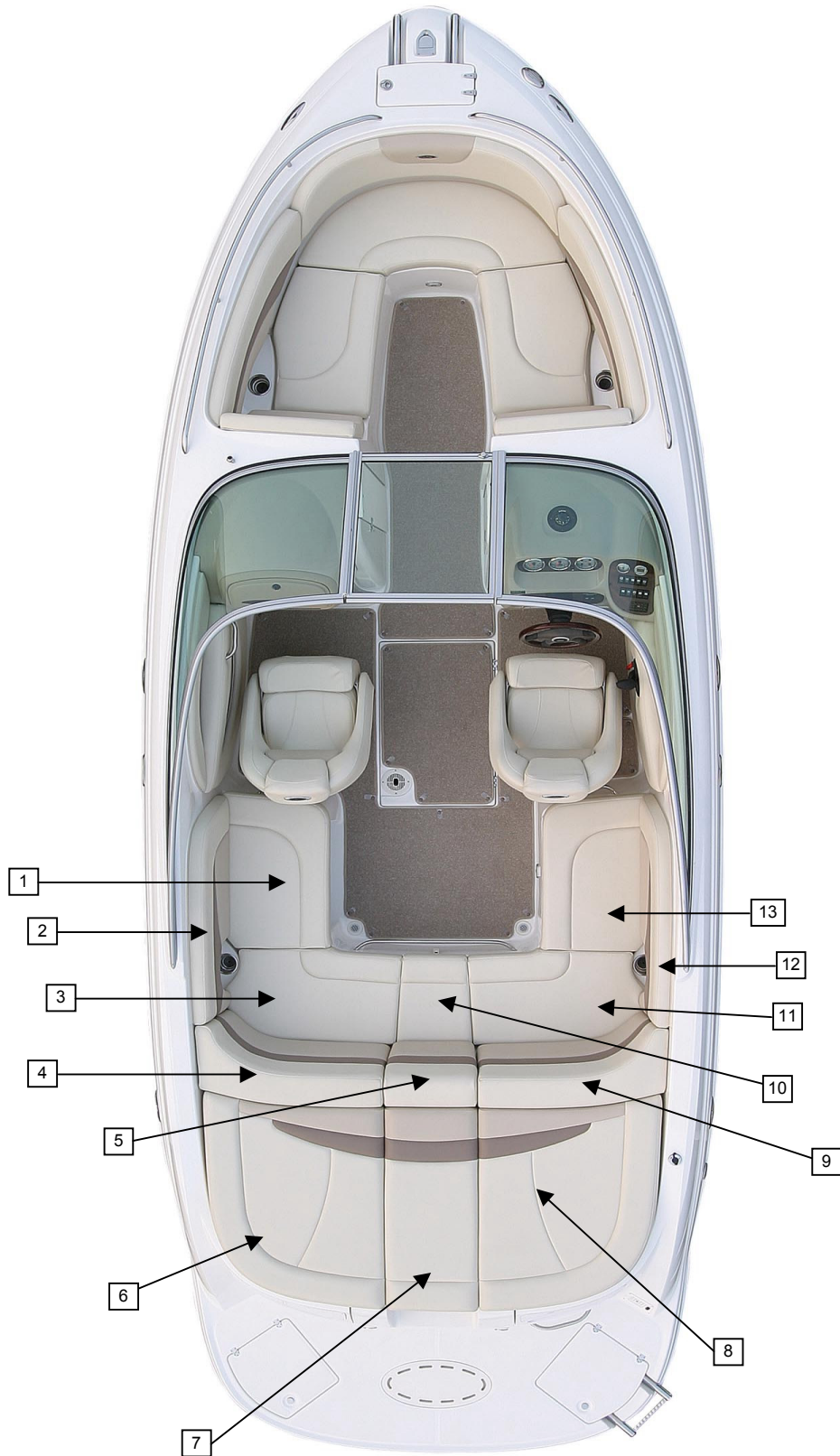

# PARTS IDENTIFICATION GUIDE

## 236 SSI 2005 MODEL YEAR

### STERN SEATING

Item No.	Part Number	Description	Qty.	U.O.M.
<del>4</del>	3	503362INT	1	ea
<del>4a</del>	3a	503362INT-S	1	ea
2		503366INT	1	ea
2a		503366INT-S	1	ea
<del>3</del>	1	503361INT	1	ea
<del>3a</del>	1a	503361INT-S	1	ea
4		503368INT	1	ea
4a		503368INT-S	1	ea
5		503370INT	1	ea
5a		503370INT-S	1	ea
6		503358INT	1	ea
6a		503358INT-S	1	ea
7		503359INT	1	ea
7a		503359INT-S	1	ea
8		503360INT	1	ea
8a		503360INT-S	1	ea
9		503369INT	1	ea
9a		503369INT-S	1	ea
10		503363INT	1	ea
10a		503363INT-S	1	ea
<del>11</del>	13	503365INT	1	ea
<del>11a</del>	13a	503365INT-S	1	ea
12		503367INT	1	ea
12a		503367INT-S	1	ea
<del>13</del>	11	503364INT	1	ea
<del>13a</del>	11a	503364INT-S	1	ea
not pictured		503451INT	1	ea
not pictured		503451INT-S	1	ea
not pictured		503449T	1	ea
not pictured		503479OPT	1	ea
not pictured		503479OPT-S	1	ea
not pictured		503480OPT	1	ea
not pictured		503480OPT-S	1	ea

*For part numbers with an "INT", "OPT" or "SNC" suffix,  
add "-901" extension for a CHAMPAGNE boat; "-902" for PLATINUM boat.*

**NOTE: Numbers with letter designations represent parts included with  
primary numbered part for which there is no photo representation.**

# PARTS IDENTIFICATION GUIDE

236 SSi  
2005 MODEL YEAR  
SIDE PANELS

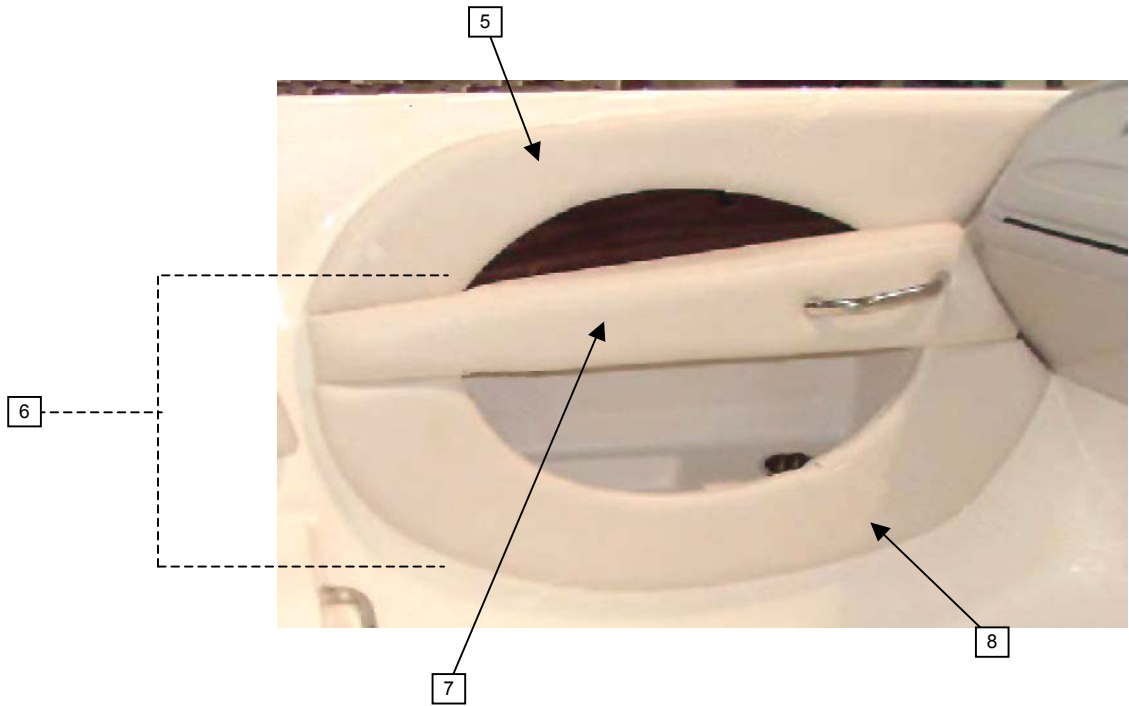
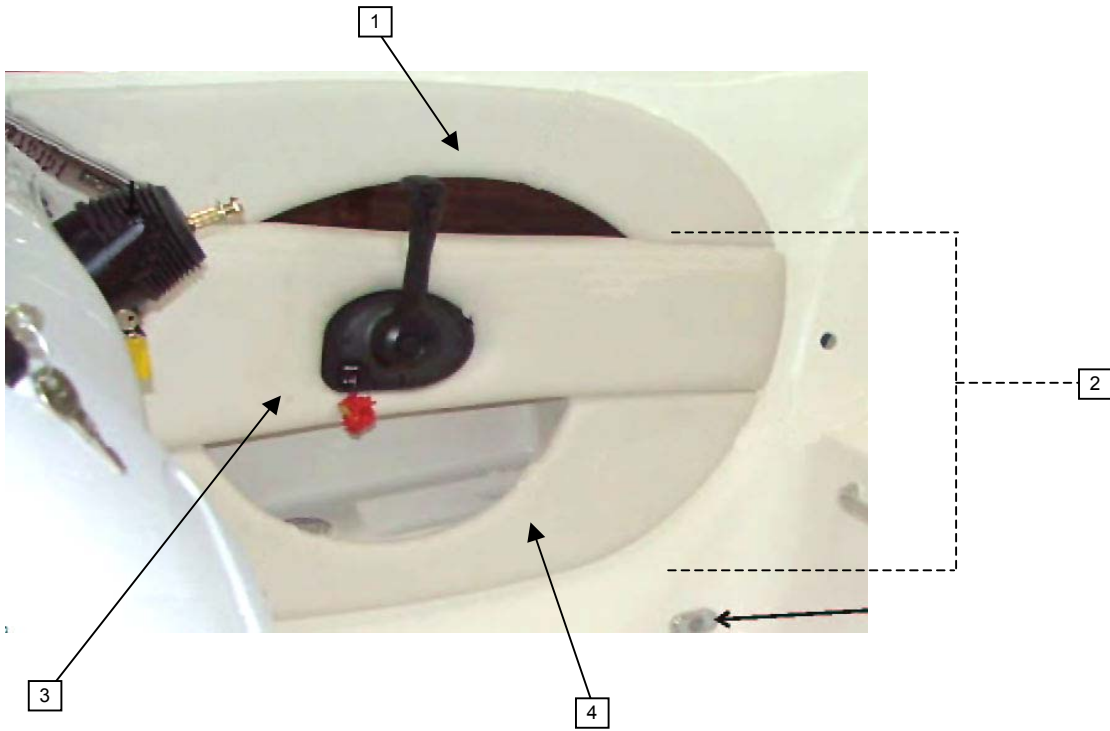

# PARTS IDENTIFICATION GUIDE

## 236 SSi 2005 MODEL YEAR

### SIDE PANELS

Item No.	Part Number	Description	Qty.	U.O.M.
1	503338INT	Starboard Upper Side Panel	1	ea
1a	503338INT-S	Starboard Upper Side Panel Skin	1	ea
2	503339INT	Starboard Side Panel Assembly	1	ea
2a	503339INT-S	Starboard Side Panel Assembly Skin	1	ea
3	503340INT	Starboard Arm Rest	1	ea
3a	503340INT-S	Starboard Arm Rest Skin	1	ea
4	503341INT	Starboard Lower Side Panel	1	ea
4a	503341INT-S	Starboard Lower Side Panel Skin	1	ea
5	503342INT	Port Upper Side Panel	1	ea
5a	503342INT-S	Port Upper Side Panel Skin	1	ea
6	503343INT	Port Side Panel Assembly	1	ea
6a	503343INT-S	Port Side Panel Assembly Skin	1	ea
7	503344INT	Port Arm Rest	1	ea
7a	503344INT-S	Port Arm Rest Skin	1	ea
8	503345INT	Port Lower Side Panel	1	ea
8a	503345INT-S	Port Lower Side Panel Skin	1	ea

*For part numbers with an "INT", "OPT" or "SNC" suffix,  
add "-901" extension for a CHAMPAGNE boat; "-902" for PLATINUM boat.*

**NOTE: Numbers with letter designations represent parts included with  
primary numbered part for which there is no photo representation.**

# PARTS IDENTIFICATION GUIDE

236 SSi  
2005 MODEL YEAR  
CARPET BOARDS

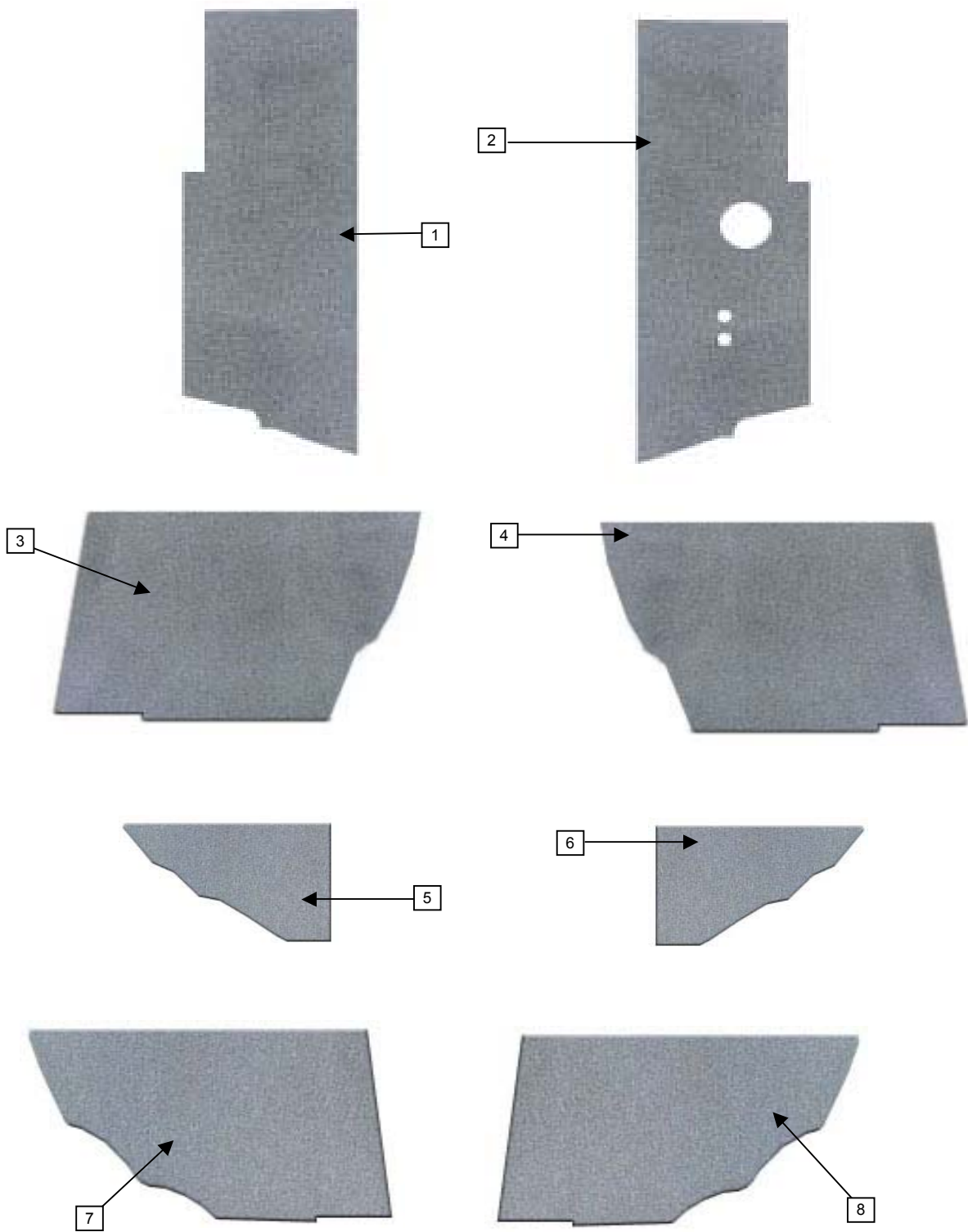

# PARTS IDENTIFICATION GUIDE

## 236 SSi 2005 MODEL YEAR

### CARPET BOARDS

Item No.	Part Number	Description	Qty.	U.O.M.
1	503371INT	Port Engine Bulkhead	1	ea
1a	503371INT-S	Port Engine Bulkhead Skin	1	ea
2	503372INT	Starboard Engine Bulkhead	1	ea
2a	503372INT-S	Starboard Engine Bulkhead Skin	1	ea
3	503373INT	Port Aft Storage Bulkhead	1	ea
3a	503373INT-S	Port Aft Storage Bulkhead Skin	1	ea
4	503374INT	Starboard Aft Storage Bulkhead	1	ea
4a	503374INT-S	Starboard Aft Storage Bulkhead Skin	1	ea
5	503375INT	Port Forward Bulkhead	1	ea
5a	503375INT-S	Port Forward Bulkhead Skin	1	ea
6	503376INT	Starboard Forward Bulkhead	1	ea
6a	503376INT-S	Starboard Forward Bulkhead Skin	1	ea
7	503377INT	Port Forward Storage Bulkhead	1	ea
7a	503377INT-S	Port Forward Storage Bulkhead Skin	1	ea
8	503378INT	Starboard Forward Storage Bulkhead	1	ea
8a	503378INT-S	Starboard Forward Storage Bulkhead Skin	1	ea

*For part numbers with an "INT", "OPT" or "SNC" suffix,  
add "-901" extension for a CHAMPAGNE boat; "-902" for PLATINUM boat.*

**NOTE: Numbers with letter designations represent parts included with  
primary numbered part for which there is no photo representation.**

# PARTS IDENTIFICATION GUIDE

236 SSi  
2005 MODEL YEAR  
CARPET BOARDS (cont.)

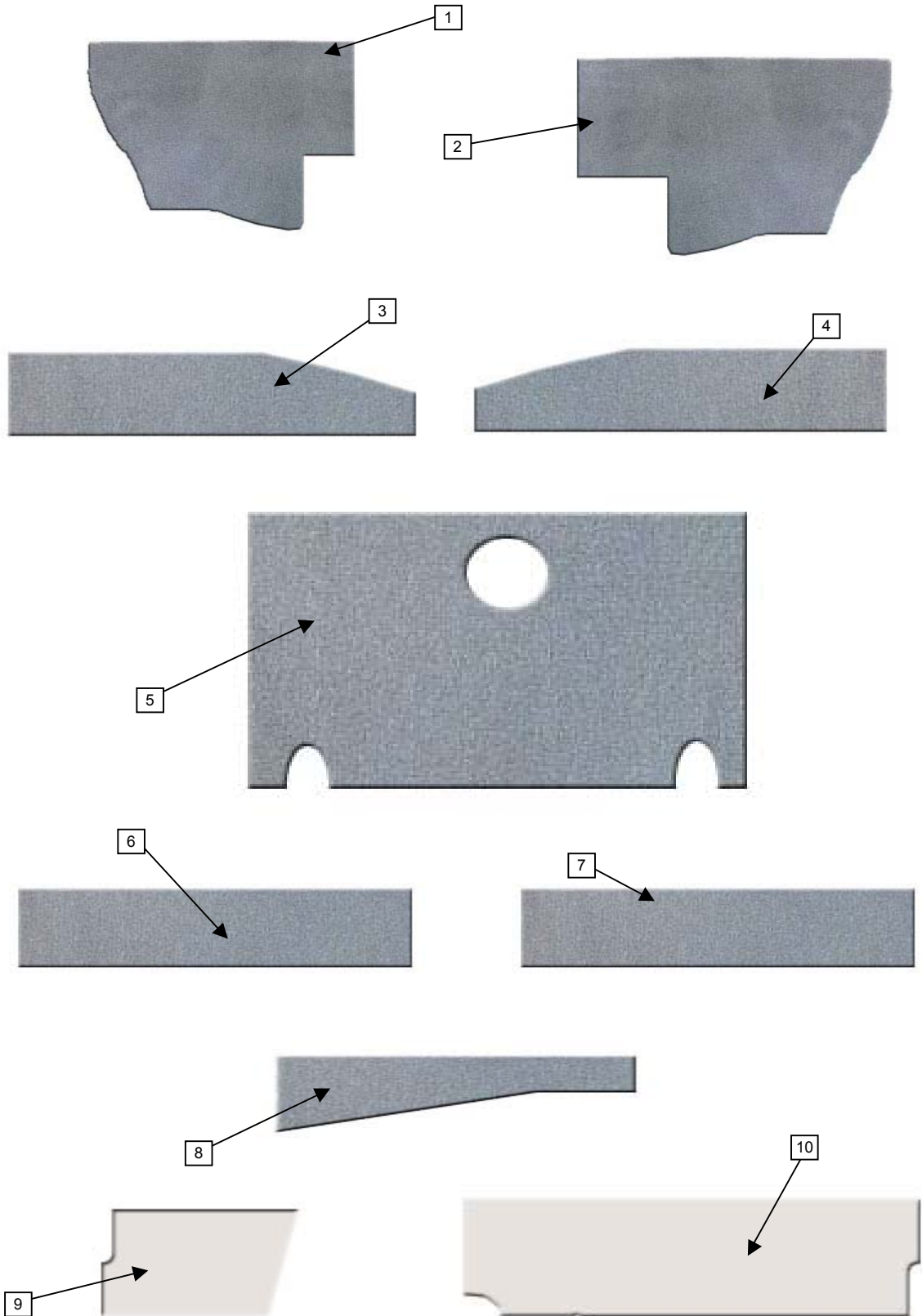



# PARTS IDENTIFICATION GUIDE

## 236 SSi 2005 MODEL YEAR

### CARPET BOARDS (cont.)

Item No.	Part Number	Description	Qty.	U.O.M.
1	503379INT	Port Rear Close Out	1	ea
1a	503379INT-S	Port Rear Close Out Skin	1	ea
2	503380INT	Starboard Rear Close Out	1	ea
2a	503380INT-S	Starboard Rear Close Out Skin	1	ea
3	503381INT	Port Forward Storage Floor #1	1	ea
3a	503381INT-S	Port Forward Storage Floor #1 Skin	1	ea
4	503382INT	Starboard Forward Storage Floor #1	1	ea
4a	503382INT-S	Starboard Forward Storage Floor #1 Skin	1	ea
5	503383INT	Fuel Tank Cover	1	ea
5a	503383INT-S	Fuel Tank Cover Skin	1	ea
6	503431INT	Port Forward Storage Floor #2	1	ea
6a	503431INT-S	Port Forward Storage Floor #2 Skin	1	ea
7	503432INT	Starboard Forward Storage Floor #2	1	ea
7a	503432INT-S	Starboard Forward Storage Floor #2 Skin	1	ea
8	503458INT	Engine Well End Cap	2	ea
8a	503458INT-S	Engine Well End Cap Skin	2	ea

*For part numbers with an "INT", "OPT" or "SNC" suffix,  
add "-901" extension for a CHAMPAGNE boat; "-902" for PLATINUM boat.*

9	503463INT	Engine Compartment Storage Board #1	1	ea
10	503464INT	Engine Compartment Storage Board #2	1	ea

**NOTE: Numbers with letter designations represent parts included with  
primary numbered part for which there is no photo representation.**

# PARTS IDENTIFICATION GUIDE

236 SSi  
2005 MODEL YEAR

## Panel Kit

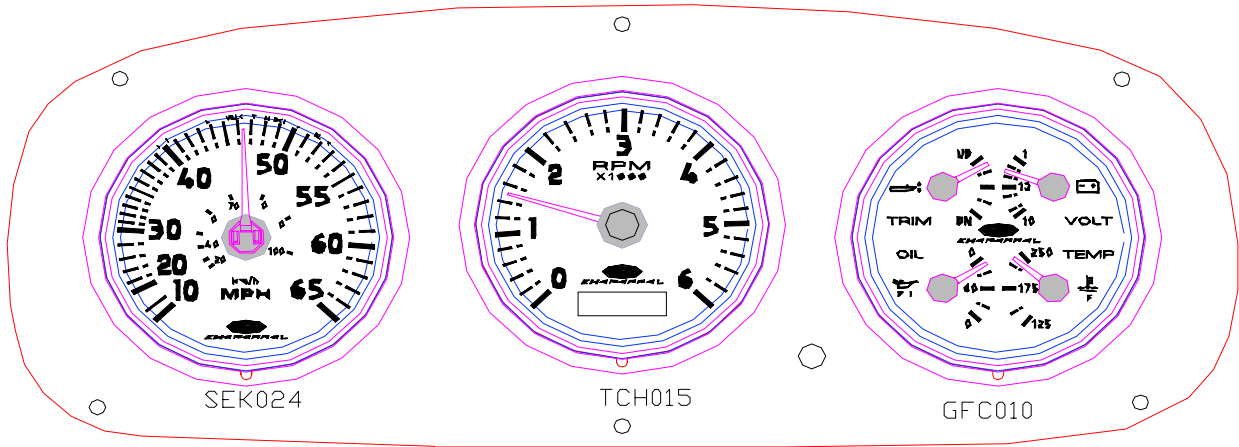

205-00217-A  
INSTRUMENT PANEL

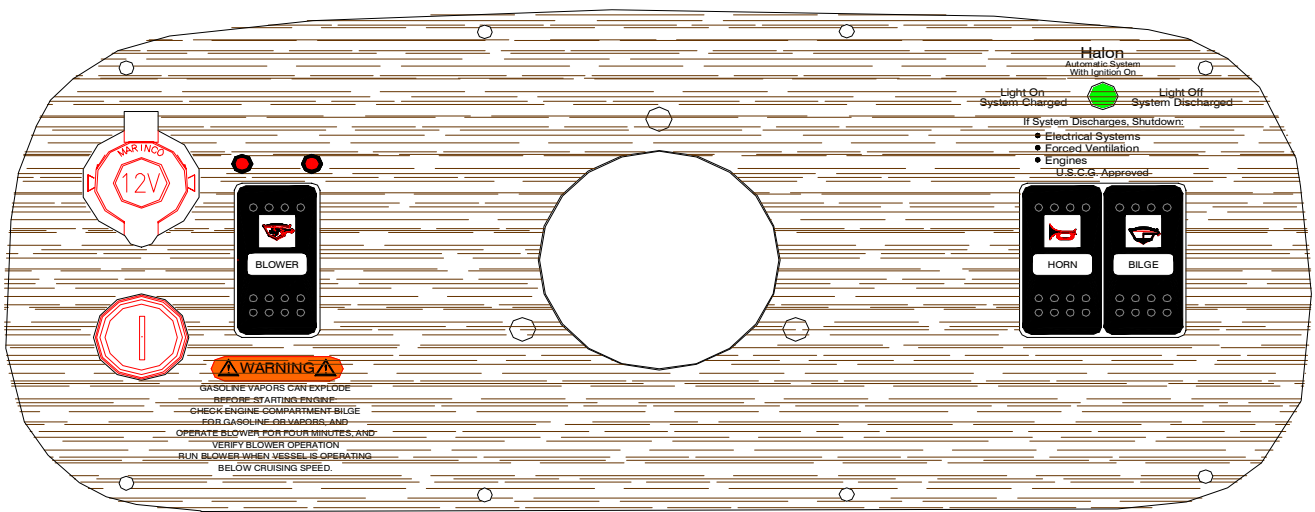

205-00219-A  
STEERING/SWITCH PANEL

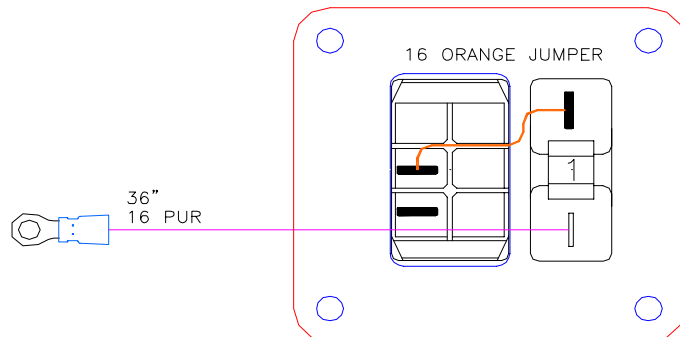
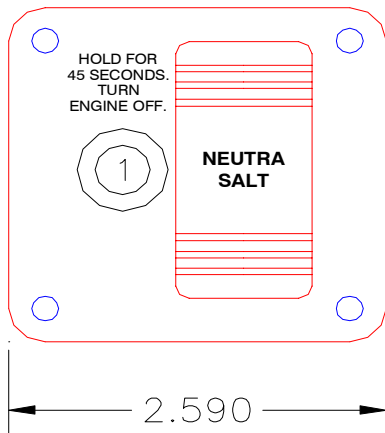

205-00164  
SE NEUTRA SALT PANEL

# PARTS IDENTIFICATION GUIDE

236 SSI

2005 MODEL YEAR

## Panel Kit

Part Number	Description	Qty.	U.O.M.
203-00298	236SSI DIST HARNESS	1	EA
203-00302-A	236SSI ENGINE HARNESS	1	EA
205-00106-A	BILGE BREAKER PANEL 216/236SUN/256S	1	EA
205-00164	PANEL- NEUTRA SALT SE (Volvo OSI Engines Only)	1	EA
205-00181-A	MERC TRANSOM TRIM PANEL SE (Option: Premium Pkgs W/Merc Engines)	1	EA
205-00182-A	VOLVO SE TRANSOM TRIM PANEL (Option: Premium Pkgs W/Volvo Engines)	1	EA
205-00217-A	INSTRUMENT PANEL 256SSI	1	EA
205-00219-A	STEERING/SWITCH PANEL 256SSI	1	EA
205-00298-A	236SSI SWITCH/GA PANEL	1	EA
205-00299-A	WIRING - CIRCUIT BREAKER PANEL TAN (Champagne Interior)	1	EA
205-00300-A	WIRING - CIRCUIT BREAKER PANEL GREY (Platinum Interior)	1	EA
205-00306-A	WIRING - BATTERY SWITCH PANEL - DUAL (Option: Dual Battery & Int'l Dual Batt)	1	EA
205-00307-A	WIRING - BATTERY SWITCH PANEL - SINGLE	1	EA
220-01444-H	TRANSOM DRAIN WIRE	1	EA
220-02197-H	15FT.STERO REMOTE HARNESS REPLACES (Option: Premium Pkgs)	1	EA
220-02721-C	Y-REMOTE HARNESS (Option: Premium Pkgs)	1	EA
790-03081209	280SIG VACUFORM COVER	1	EA
GBC028	2" FUEL LEVEL GAUGE	1	EA
GFC010	GAUGE - 4" 4 IN 1 80# OIL, 100-250 TEMP, 10-16 VOLT, & TRIM	1	EA
SEK024	4" 65 MPH MECHANICAL SPEEDOMETER	1	EA
THC015	4" 6000 RPM TACH - HOURMETER	1	EA

# PARTS IDENTIFICATION GUIDE

**236 SSi**  
**2005 MODEL YEAR**

## Panel Kit

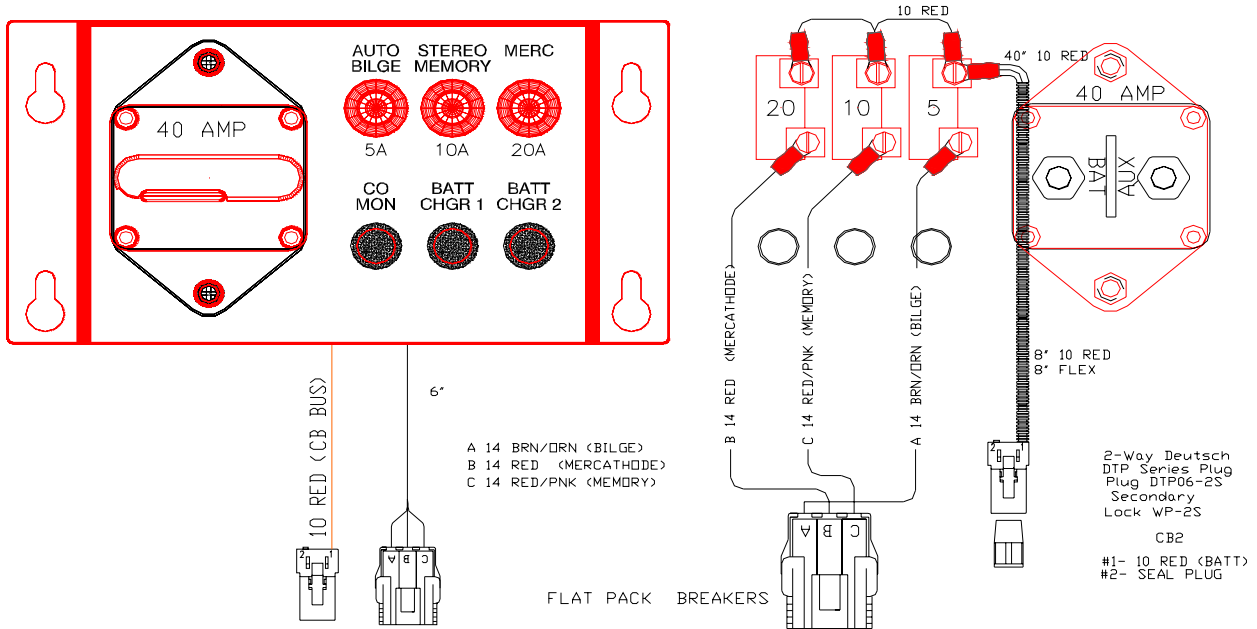

**205-00106-A**  
**BILGE BREAKER BOX ASSEMBLY**

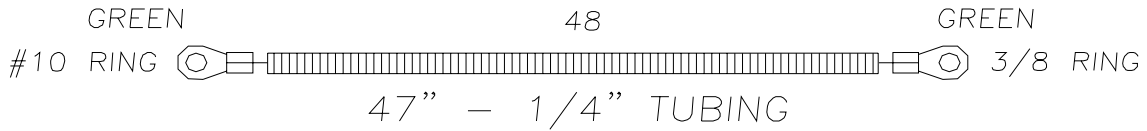

**220-01444-H**  
**TRANSOM DRAIN WIRE**

THIS PANEL USES THE 150 PACKARD CONNECTORS - PLUGGED :  
A - RED/PUR  
B - LT BLU  
C - GRN/WHT

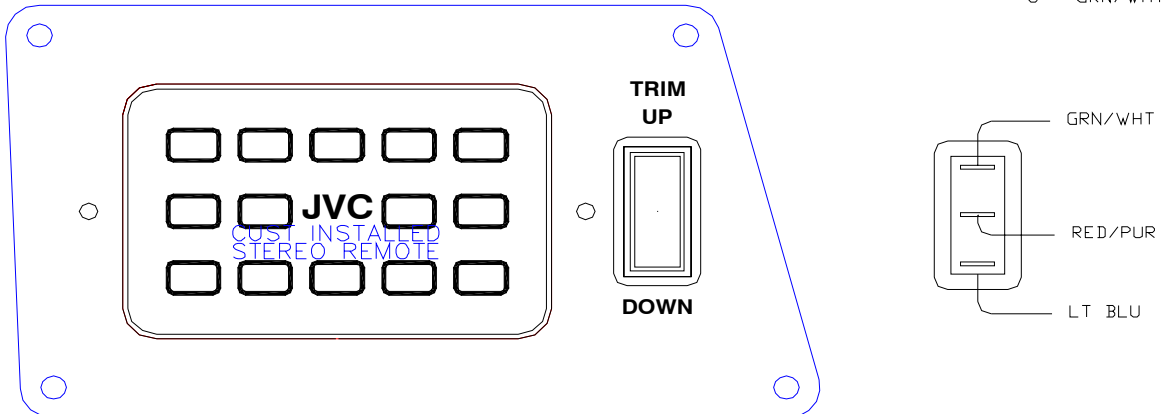

**205-00181-A**  
**MERC TRANSOM TRIM PANEL SE**

# PARTS IDENTIFICATION GUIDE

**236 SSi**  
**2005 MODEL YEAR**

## Panel Kit

THIS PANEL USES THE 3 WAY MOLDED PLUGS

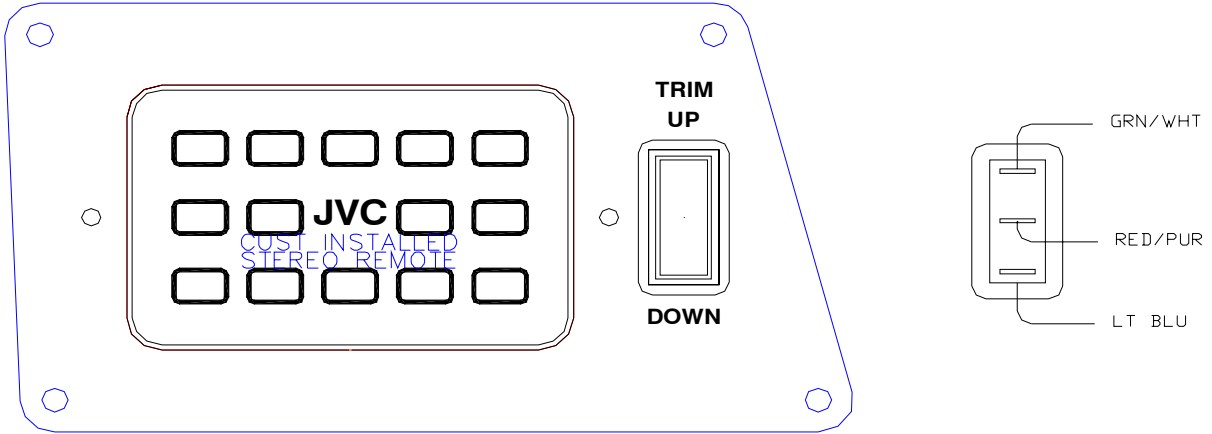

**205-00182-A**  
**VOLVO SE TRANSOM TRIM PANEL**

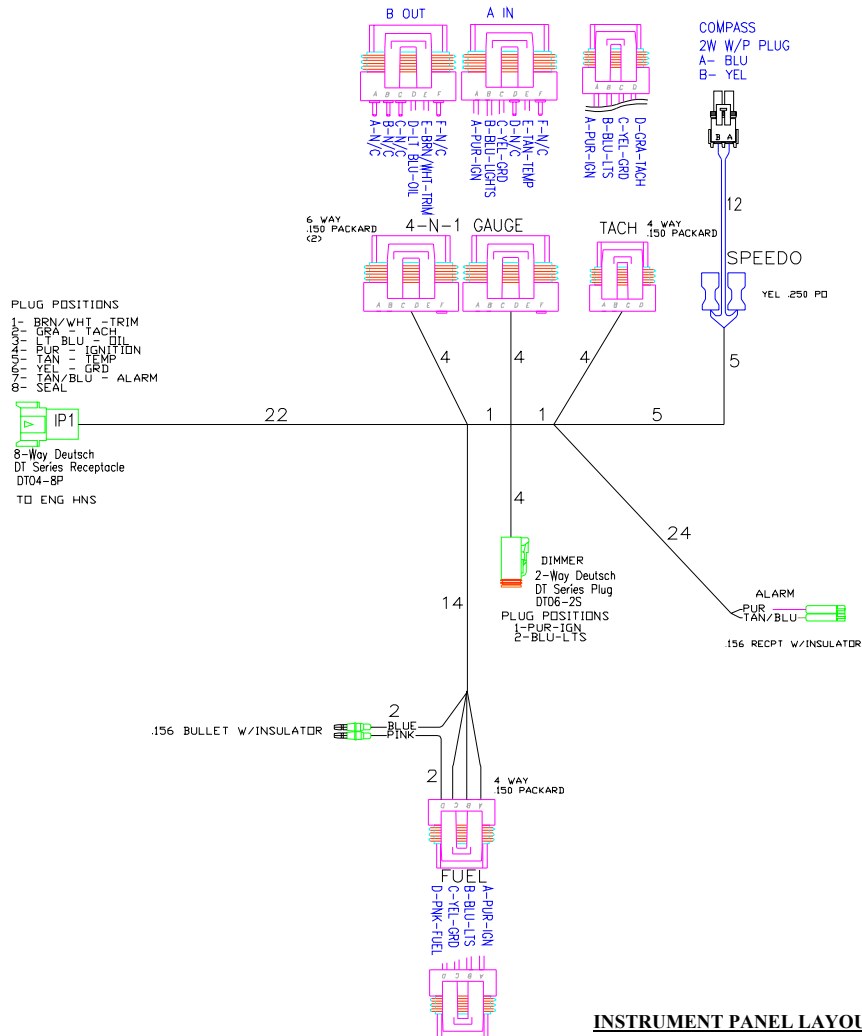

**INSTRUMENT PANEL LAYOUT**

# PARTS IDENTIFICATION GUIDE

236 SSi  
2005 MODEL YEAR

## Panel Kit

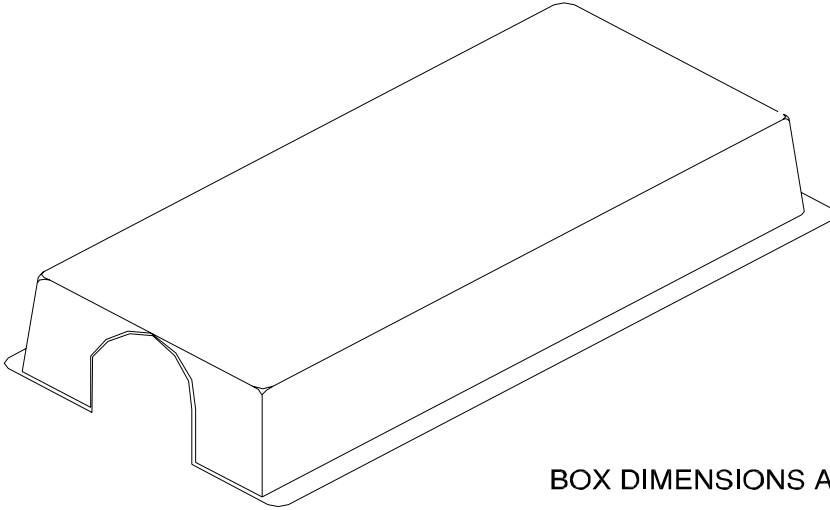

BOX DIMENSIONS ARE 7" x 15.5"

790-03081209  
280SIG VACUFORM COVER

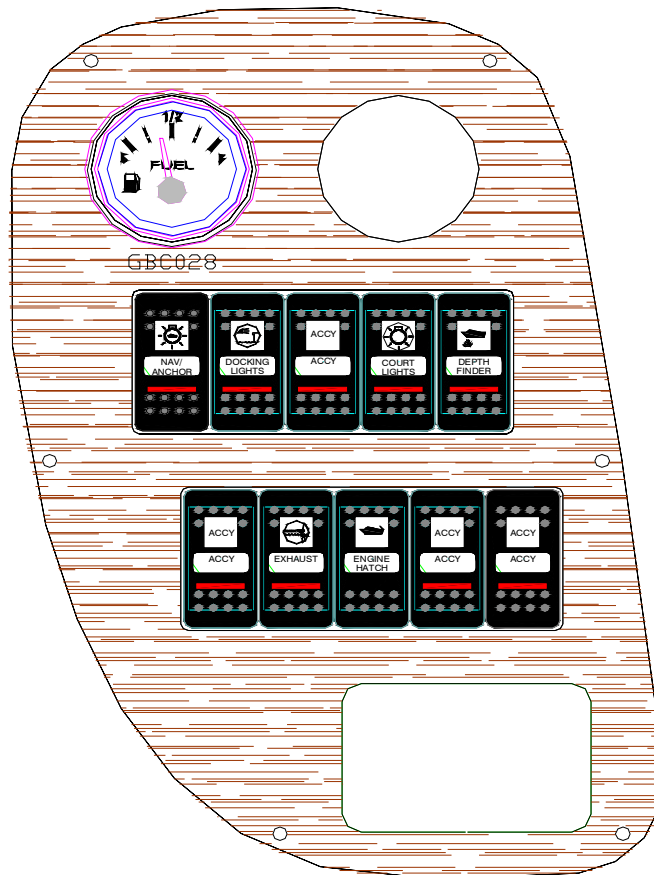

205-00298-A  
236 SSI SWITCH/GA PANEL

# PARTS IDENTIFICATION GUIDE

**236 SSI**  
**2005 MODEL YEAR**

## Panel Kit

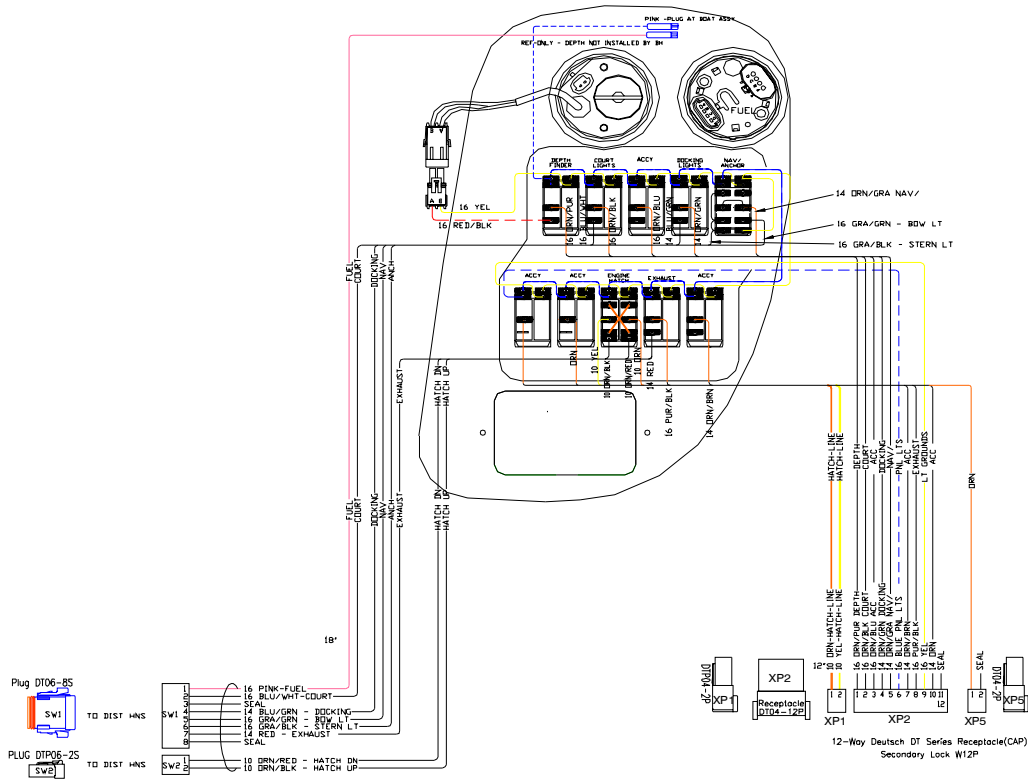

**205-00298-A**  
**236 SSI SWITCH/GA PANEL**

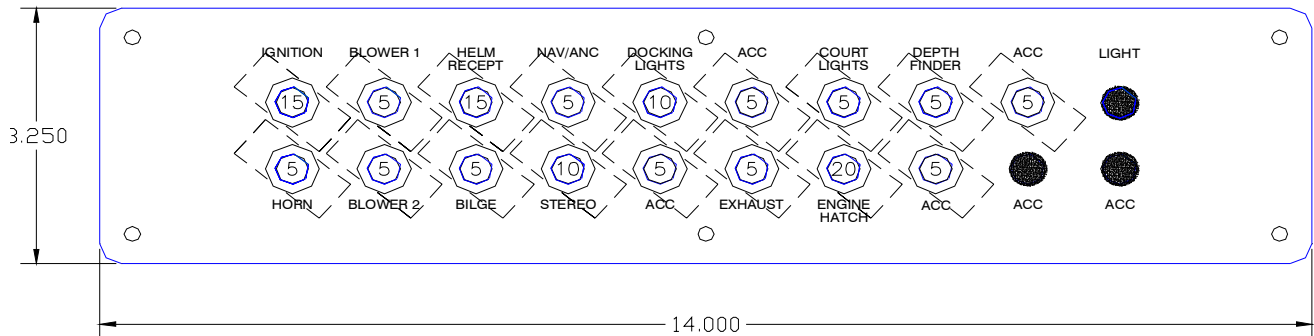

**205-00299-A & 205-00300-A**  
**CIRCUIT BREAKER PANELS**

# PARTS IDENTIFICATION GUIDE

## 236 SSi

### 2005 MODEL YEAR

#### Panel Kit

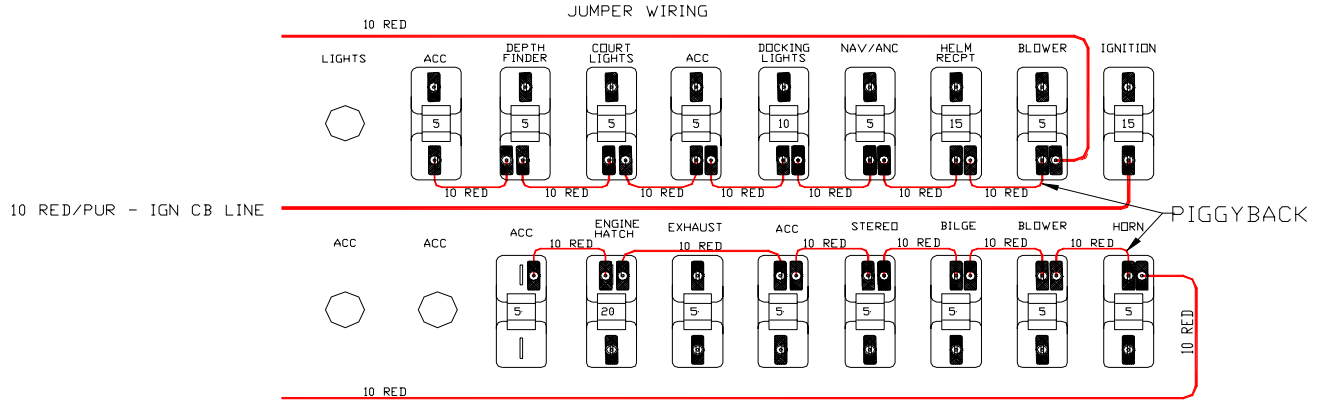

205-00299-A & 205-00300-A  
CIRCUIT BREAKER PANELS

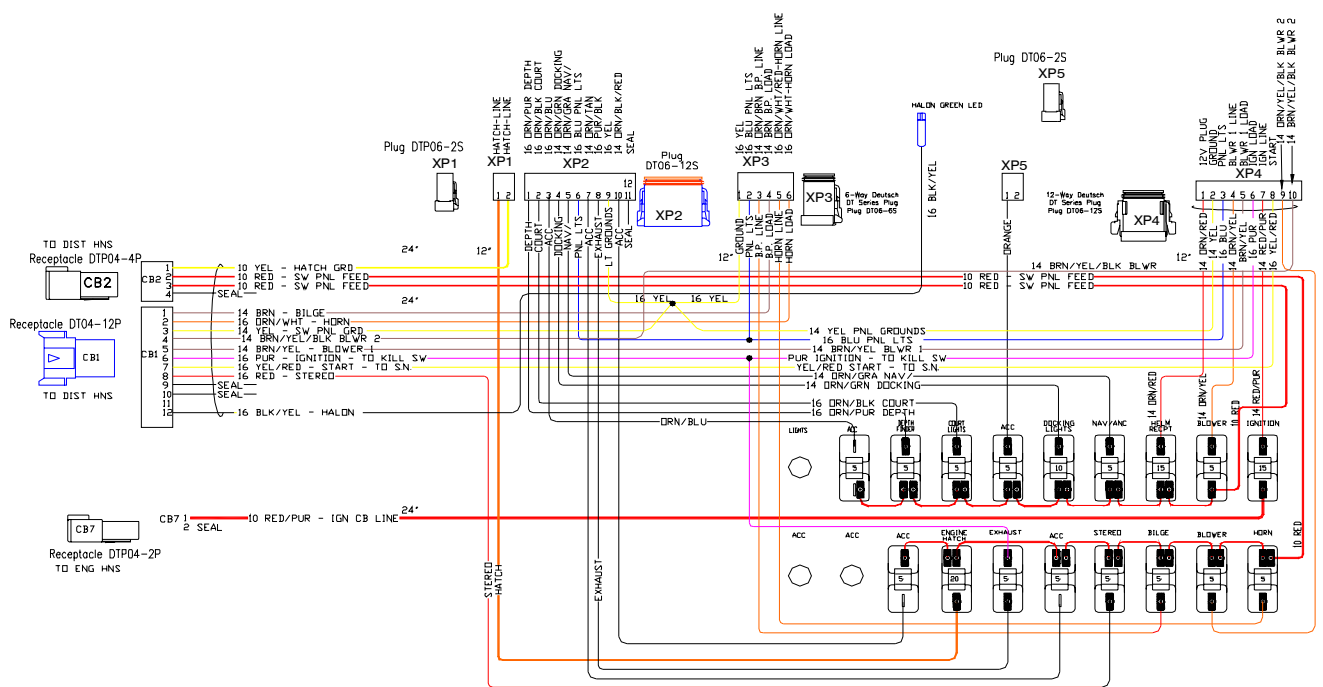

205-00299-A & 205-00300-A  
CIRCUIT BREAKER PANELS



# PARTS IDENTIFICATION GUIDE

**236 SSi**  
**2005 MODEL YEAR**

## Panel Kit

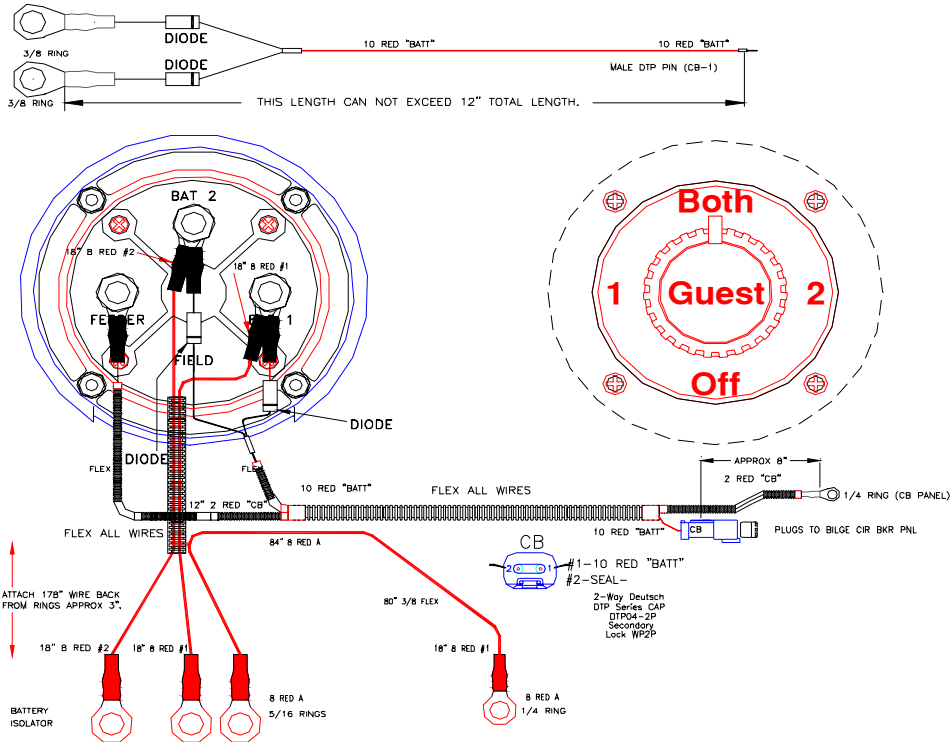

**205-00306-A**

### WIRING-BATTERY SWITCH PANEL-DUAL

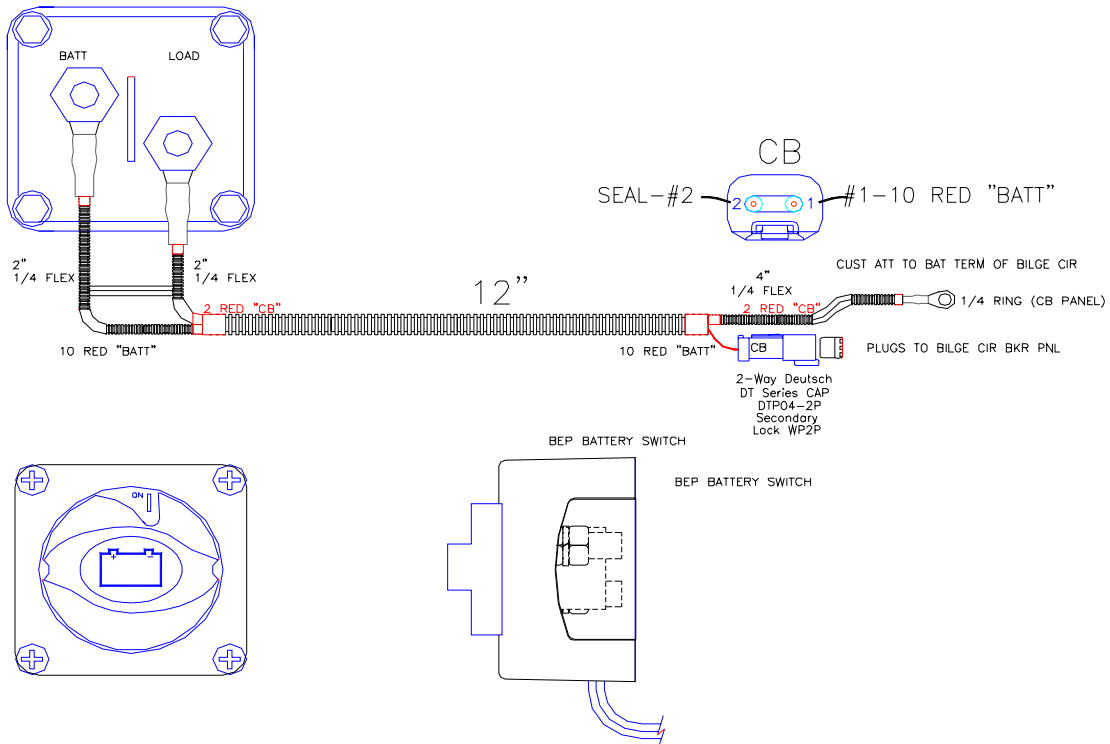

**205-00307-A**

### WIRING-BATTERY SWITCH PANEL-SINGLE

# PARTS IDENTIFICATION GUIDE

**236 SSi**  
**2005 MODEL YEAR**

## Panel Kit

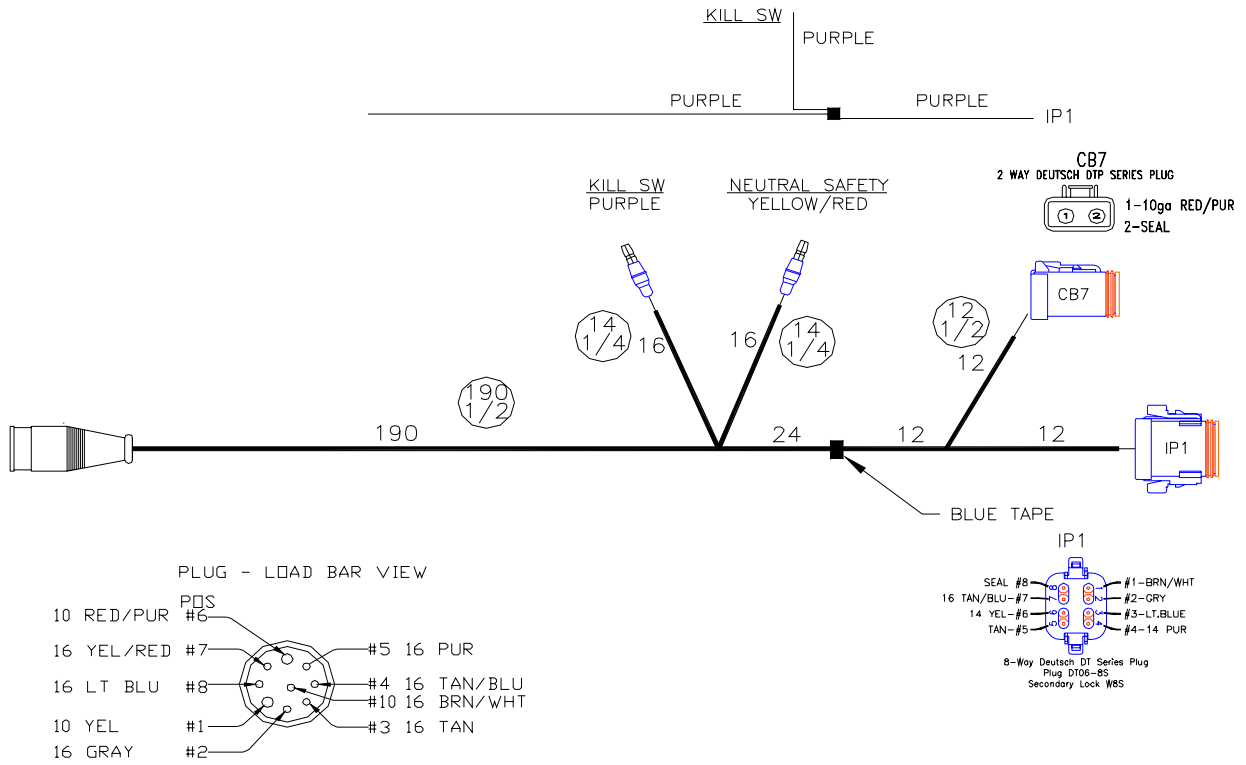

**203-00302-A**  
**236 SSI ENGINE HARNESS**

# PARTS IDENTIFICATION GUIDE

236 SSI  
2005 MODEL YEAR

## Panel Kit

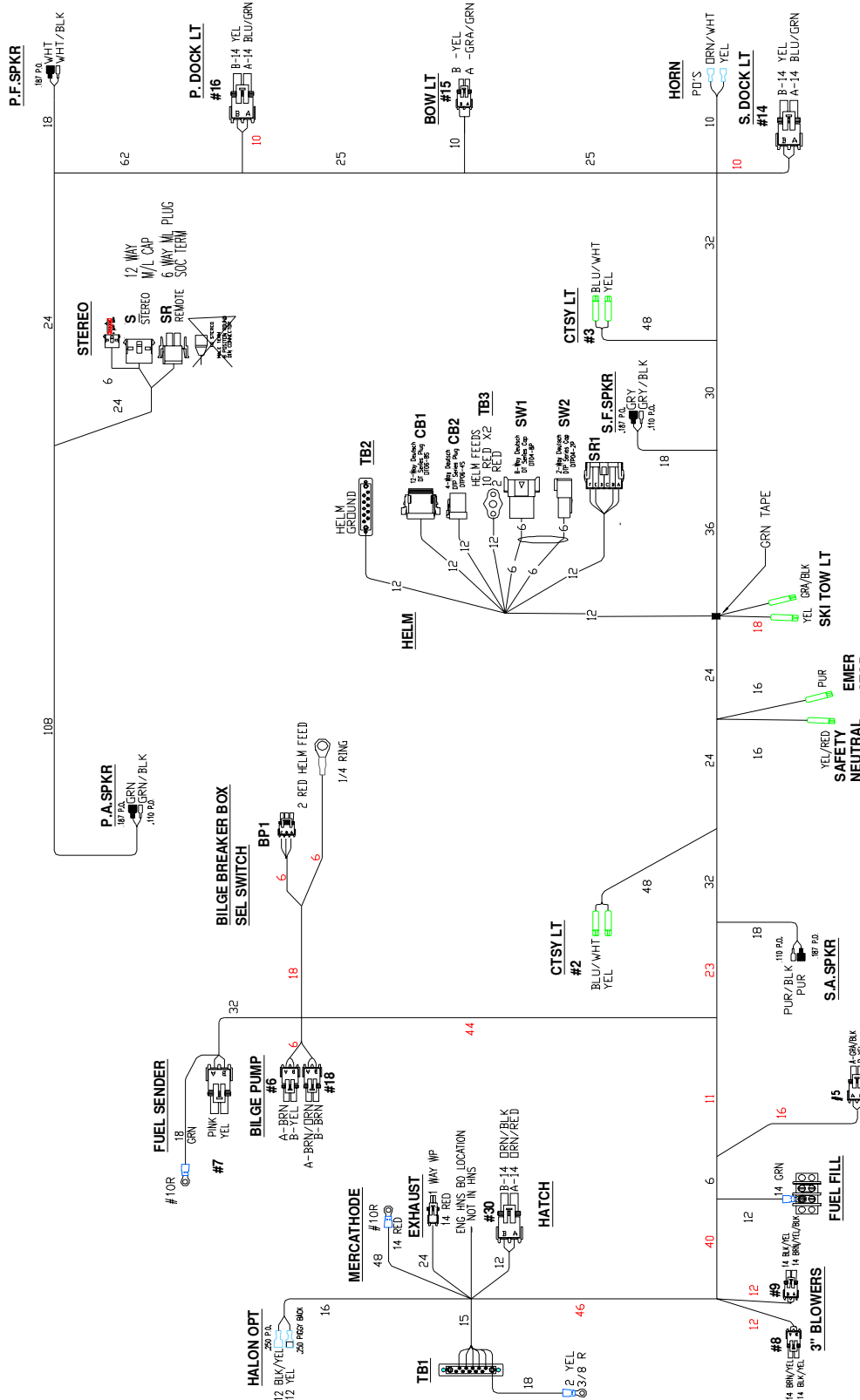

PLUGGING PIN POSITIONS	
<b>SW1</b> 8-Way Deutsch DT Series Cop DTP04-8P 1-16 PINK/FUEL - COURT 2-SEAL 4-14 BLU/GRN - DOCKING 5-16 GRA/GRN - BOW LT 6-16 GRA/BLK - STERN LT 7-14 RED - EXHAUST 8-14 SEAL	<b>SW2</b> 2-Way Deutsch DTP Series Cop DTP04-2P 1-10 DRN/RED - HATCH DN 2-10 DRN/BLK - HATCH UP
<b>CB2</b> 4-Way Deutsch DTP Series Plug DTP06-4S 1-10 YEL - HATCH GRD 2-10 RED - SW PNL FEED 3-10 RED - SW PNL FEED 4-10 SEAL	<b>CB1</b> 12-Way Deutsch DT Series Plug DTP06-12S 1-14 BRN - BILGE PUMP 2-16 DRN/WHT - HORN 3-16 YEL - PNL GROUNDS 4-14 BRN/YEL - BLOWER 2 5-14 BRN/YEL - BLOWER 1 6-16 PUR - IGNITION - TO KILL SW 7-16 YEL/RED - START - TO S.N. 8-16 RED - STEREO 9-16 SEAL 10-16 SEAL 11-16 SEAL 12-16 BLK/YEL - HALON
<b>BP1</b> 3-Way WEATHERPACK PLUG A-14 BRN/GRN - BILGE B-14 RED - MERCATHODE C-14 RED/PINK - STEREO MEMORY	<b>SRI</b> STEREO REMOTE 6 WAY WP CAP A - BLACK B - BLANK C - BLANK D - BLANK E - RED F - RED
<b>S</b> STEREO 12 WAY W/L CAP #1-12 BLK/GRN #13-BLK #14-GRN/BLK #15-GRN #16-BLK #17-GRN/BLK #18-RED/GRN #19-GRN/BLK #20-RED/PNK	<b>SR</b> STEREO REMOTE 6 WAY ML PLUG SOC TERM #1-12 ML PLUG 1-BLK 2-BLK 3-BLK 4-BLK 5-BLK 6-BLK