

Signature 270

PARTS IDENTIFICATION GUIDE INDEX

SIGNATURE 270

2004 MODEL YEAR

<u>DESCRIPTION</u>	<u>ID. PAGE NO.</u>	<u>DESCRIPTION PAGE NO.</u>
Deck - Overhead View (includes the following)	10	11
Anchor, Lid & Hardware		
Arch Antenna Option		
Bow Lights		
Bow Rails		
Bow Roller		
Deck Hatches		
Drop In Horn & Grills		
Hatch & Skyscreen		
Port Seat Drink Holder & Glove Box		
Radar Arch Option		
Remote Spotlight Option		
Rod Holder Option		
Swim Platform & Components		
Windlass Option		
Windshield Parts		
HULL & DECK EXTERIOR (includes the following)	12	13
Anchor Chafe Plate		
Bow Eye		
Drain Plug		
Dunnage Boxes & Components		
End Caps		
Fuel Fill		
Grabrails		
Med Streamline Hull Anode		
Platform Braces		
Port Lights		
Rubrail & Insert		
Shore Power		
Trim Tabs		
Thru Hulls		
Transom Lights		
Transom Shower		
Transom Stereo Remote		
Vents & Vent Covers		
GRAPHICS (includes the following)	14	15
Bird Head Logo		
Chaparral Lettering & Bird		
Deck Tapes		
Extended Hull Decal		
Hull Flares		
Hull Tapes		
Model Designator & Chrome Designator		
Protected Design Decal		

PARTS IDENTIFICATION GUIDE INDEX

SIGNATURE 270

2004 MODEL YEAR

<u>DESCRIPTION</u>	<u>ID. PAGE NO.</u>	<u>DESCRIPTION PAGE NO.</u>
FORWARD CABIN (includes the following) AC Panel Cabinet & Components Cabin Door Trim Cabin Steps Carbon Monoxide Detector Dinette Cabinet & Components Dinette Table Forward Cabin Cabinets & Components Halogen Lights Light Harness for AC/DC Light Switches & Power Outlets Sliding Cabin Door Option Stereo/CD Player	16	17
ALTERNATING CURRENT ELECTRICAL SYSTEM (includes the following) 110V & 220V Electrical Wiring Components	N/A	19
AFT CABIN (includes the following) Aft Storage Box Halogen Lights Portlight	20	21
GALLEY (includes the following) Cabinets With Hardware Counter Top Drawers Drain Components Faucet & Sink Galley Rails Indirect Lighting Light Harness Wiring Light Switches & Power Plugs Microwave Refridgerator Stove Television	22	23
HEAD (includes the following) Access Panel Blower & Hoses Bronze Plex Door Door & Door Ring Drain Components Faucet & Sink Halogen Lights Head Rails Mirror Towel Set Option	24	25
Air Conditioning (includes the following) 110V & 220V Air Conditioning Option	26,28	27,29

PARTS IDENTIFICATION GUIDE INDEX

SIGNATURE 270

2004 MODEL YEAR

<u>DESCRIPTION</u>	<u>ID. PAGE NO.</u>	<u>DESCRIPTION PAGE NO.</u>
DASH / HELM (includes the following)	30,32	31,33
Compass		
Console & Components		
Courtesy Light		
Dash Kit & Components		
Depth Finder		
Engine Components		
Kill Switch		
Panel Kit With Gauges		
Ray Nav GPS Option		
Steering Cable		
Steering Wheel		
Stereo Remote		
VHF Radio Option		
Windshield		
Windshield Wiper Motor		
COCKPIT (includes the following)	34	35
Access Door		
Battery Panel		
Cockpit Tubs & Drains		
Transom Light		
Cup Holders		
Engine Lid With Hardware		
Fire Port		
Grabrails		
Macerator Panel Option		
Speakers		
Stereo Remotes		
Table & Storage		
Transom Door & Lock		
Transom Shower		
Cockpit & Cockpit Galley (includes the following)	36	37
Ceramic Tap		
Cockpit Rails		
Igloo Retainer		
Marine Cooler		
Speakers		
White GFCI Assembly & Cover		
Deck Underside (includes the following)	38	39
Aft Liner Drains		
Cockpit Galley Drain		
4" Blower Hoses		
Forward Liner Drain		
Fuel Hose		
Engine Lid With Hardware		
Port Seat Tub & Drain		

PARTS IDENTIFICATION GUIDE INDEX

SIGNATURE 270

2004 MODEL YEAR

<u>DESCRIPTION</u>	<u>ID. PAGE NO.</u>	<u>DESCRIPTION PAGE NO.</u>
ENGINE WELL (includes the following) Aluminum Fuel Tank Option Aft Bilge Pump Battery Cables & Trays Battery Charger Blowers & Blower Hoses Engine Room Floor Treads Fire Extinguisher Fuel Tank Gas Vapor Detector Option Generator Option Hot Water Heater International Fuel Shut Off Option Thru Hull Transducer & Harness	40,42,N/A	41,43,45
Fresh Water (includes the following) Hose Routing Hoses & Couplings Filter Water Heater Water Pump Water Tank	46	47
Waste System (includes the following) Aft Bilge Pump Drains & Components Forward Bilge Pump Hose Routing With Couplings Shower Sump Waste Tank Water Pickup	48,50	49,51
Canvas (includes the following) Bimini Top Camper System Cockpit Cover Side Curtains	N/A	53
Overhead View (includes the following) Cockpit Table Top Cushion & Skin Drop In Carpet Helm Seat Assembly, Cushions & Skins Motor Lid Cushions & Skins Optional Sun Pad & Skin Port Seating Assembly, Cushions & Skins Stern Seating Cushions & Skins	54	55

PARTS IDENTIFICATION GUIDE INDEX

SIGNATURE 270

2004 MODEL YEAR

<u>DESCRIPTION</u>	<u>ID. PAGE NO.</u>	<u>DESCRIPTION PAGE NO.</u>
Bow Interior (includes the following) Bow Seating Assemblies, Cushions & Skins Cabin Drop In Carpet Curtain Valances Mirror & Speaker Frames	56	57
Dinette / Aft Cabin (includes the following) Aft Birth Mirror Aft Cabin Assembly, Cushions & Skins Aft Cabin Mattress & Skin Aft Privacy Curtians Aft Sleeper Storage Cabinets & Skins Cabin Snap in Carpet Ceiling Face Panel & Skin Dinette Seating Assembly, Cushions & Skins Head Curtians Vanity Face Panel & Skin	58	59
Ceiling Panels/Headliner Boards (includes the following) Aft Entryway Curtian Tracking System Cabin Ceiling Panels & Skins	60	61
Headliner Boards (includes the following) Aft, Berth, Bulkhead & Skins Bow Bulkheads, Mirror Board & Skins Entryway Pad & Skin	62	63
Carpet/Other Boards (includes the following) Aft Berth Bulkhead Cleat Aft Hose Cover Board & Skin V-Berth Hatch, Bulkhead & Skins	64	65

Signature 270

PARTS IDENTIFICATION GUIDE

SIGNATURE 270

2004 MODEL YEAR

Deck-Overhead View



PARTS IDENTIFICATION GUIDE

SIGNATURE 270

2004 MODEL YEAR

Deck-Overhead View

Item No.	Part Number	Description	Qty.	U.O.M.
1	35291	S270 FWD SECT W/LIGHT (Option: Remote Spotlight)	1	EA
1a	35292	S270 FWD SECT W/O LIGHT	1	EA
2	66319-1	HORIZONTAL SIDELIGHT	1	PR
3	3-1101	SIG 290 ANCHOR LID	1	EA
3a	SL0057406/F	14LB. DELTA ANCHOR (Option: Custom Anchor)	1	EA
3b	66009-1	6 INCH CLEAT-HOLLOW BASE (Inside Anchor Locker)	1	EA
4	CHAP550-01	FOOT CONTROLS FOR HORIZON 900 G. KIT (Option: Windlass)	1	EA
4a	HM30B200PX	5/8 8/PLAILED ANCHOR RODE (Option: Windlass) (Inside Anchor Locker)	1	EA
4b	220-02237-H	S270 WINDLASS HARNESS (Option: Windlass) (Inside Anchor Locker)	1	EA
4c	U13759-01	DANGER ANCHOR MAY MOVE LABEL	1	EA
5	35290	S270 BOW RAIL	1	EA
6	E32015	ANTENNA - RAYCHART 320 CHARTPLOTTER (Option: RayNav GPS)	1	EA
6a	E32015	ANTENNA (Shown Without Radar Arch Option)	1	EA
7	SSCL-66010-2SE	8 IN EURO STYLE CLEAT	6	EA
8	33110A	DLX WIPER ARM	1	EA
8a	33105	14 INCH CURVED BLADE	1	EA
8b	37181R	WIPER MOTOR W/ REV. PARK	1	EA
8c	220-02236-H	S270 WIPER HRNSS (Part of Panel Kit)	1	EA
8d	120-0580	5/8 BLACK BILGE FLEX	.16	FT
9	588-1045044	270 SIG WINDSHIELD	1	EA
9a	U13778-01	NOTICE SECURE WINDSHIELD	1	EA
10	588004504409	STARBOARD WING	1	EA
11	2600009	270 SIG ALUM RADAR ARCH (Option: Radar Arch)	1	EA
11a	220-02243-H	270 ARCH HARNESS (Option: Radar Arch)	1	EA
12	556-SPL-003	WASTE FILL WITH RETAINER	1	EA
12a	U13759-01	SYMBOL DESIGNATOR WASTE CE LABEL (Option: CE Pkg)	1	EA
13	2640	1.18 X 1.82 FM HINGE	2	EA
14	TDL-3XP	3 STEP LADDER W/HAND GRIP	1	EA
15	SP67	SWIM PLATFORM LID/DIAMOND	1	EA
16	M1-63-8	LATCH/FLUSH SS(5000 MIN)	1	EA
17	3-1178	S270 SWIM PLATFORM	1	EA
18	1281-SPL-002-P	MASTHEAD LIGHT W/ AMP CON (Option: Radar Arch)	1	EA
19	GAZ-360	ARCH ANTENNA (Option: Arch Antenna) (With Radar Arch Option)	1	EA
19a	CHRG15MF	15 FT. COAX CABLE W/HDWR. (Option: Arch Antenna) (With Radar Arch Opt)	1	EA
19b	220-01883-H	ARCH HARNESS PULL WIRE (Option: Radar Arch)	1	EA
20	588004504408	PORT WING	1	EA
20a	588004504499	HARDWARE KIT	1	EA
21	M1-63-8	LATCH/FLUSH SS(5000 MIN)	1	EA
22	270602	270 GLOVE BOX DRINK HOLDER	1	EA
23	588-1020010	22X22 HATCH	1	EA
23a	SFSS-22/22-R42	22X22 SURFACE SKYSCREEN	1	EA
24	M1-62-8	LATCH/FLUSH SS (5000 MIN)	1	EA
24a	6722	STAINLESS RUB STRIKE	1	EA
25	H20-0200	2 INCH BUTT HINGE	2	EA
26	URM-2C	BOW ROLLER W/O HOLE(25)	1	EA
27	62026-4705	SPOTLIGHT W/ CONTROL (Option: Remote Spotlight)	1	EA
27a	67492-0800	SPOTLIGHT CABLE (Option: Remote Spotlight)	24	FT
27b	K-EMIF5BUT	22-18 F.I. BUTT CONNECTOR (Option: Remote Spotlight)	8	EA
28	588004504403	PORT FRONT	1	EA
29	588004504405	CENTER PANEL	1	EA
30	588004504404	STARBOARD FRONT	1	EA

Parts Not Pictured Which Are Associated With Deck Overhead:

Not Pictured	66362-1	ROD HOLDER (Option: Rod Holders)	2	EA
Not Pictured	6732-5	#32 HOSE CLAMP (Option: Rod Holders)	1	EA
Not Pictured	NC40	2 1/2IN. ALUM. CUSH.CLAMP (Option: Rod Holders)	1	EA
Not Pictured	6356P1	TRANSOM LIGHT W/PACK.PLUG (Underside of Arch) (Option: Radar Arch)	2	EA
Not Pictured	CVR64AW	COVER PLATE 6" WHITE (Underside of Arch) (Option: Radar Arch)	2	EA
Not Pictured	1045-SPL-009-P	ROUND LIGHT BASE W/PACKARD (Delete For Arch Option)	1	EA
Not Pictured	6646	66 INCH POLE LIGHT BENT TUBE (Delete For Arch Option)	1	EA
Not Pictured	203-00012-00-A	OPT STERN LIGHT HARNESS (Delete for Arch Option)	1	EA
Not Pictured	11104	MINI AIR HORN WHITE	1	EA
Not Pictured	IST14255	S270 ANCHOR CHAIN GUARD (Inside Anchor Locker)	1	EA

PARTS IDENTIFICATION GUIDE

SIGNATURE 270

2004 MODEL YEAR

Hull / Deck Exterior



PARTS IDENTIFICATION GUIDE

SIGNATURE 270

2004 MODEL YEAR

Hull / Deck Exterior

Item No.	Part Number	Description	Qty.	U.O.M.
1	SSCL-66010-2SE	8IN EURO STYLE CLEAT	6	EA
2	540-SPL-004	GAS FILL/VENT(25)	1	EA
2a	U13808-01	SYMBOL FUEL CE LABEL (Option: CE Pkg)	1	EA
3	064B	STBD VENT	1	EA
3a	VHF-4WS	4 IN. SAND FLANGE	2	EA
4	281020020	2 INCH VENT COVER	1	EA
4a	VHF-3WS	3 IN. SAND FLANGE	1	EA
5	JB315SSCH	3 X 15 ELIPT. PORT WINDOW	5	EA
5a	U16817-01	WINDOW WARNING LABEL	6	EA
6	STA2416H12	SS INSERT 3/4 X 12	3	EA
7	01336RB9629-01Z	WHITE RUBRAIL 26 FT.	3.50	EA
8	STESW1003	1/2 X 3 7/16 BOW EYE	1	EA
9	71001	5/8IN(1/2IN) SS THRU HULL (Option: Air Conditioning)	1	EA
10	71006	1 1/2IN SS THRU HULL BARB (Galley Sink Drain)	1	EA
11	71005	1 1/4IN SS THRU HULL BARB (Head Sink Drain)	1	EA
12	71002	3/4IN SS THRU HULL BARB (Forward Bilge Drain)	1	EA
13	71002	3/4IN SS THRU HULL BARB (Helm Seat Tub Drain)	1	EA
14	71008	2IN. SS THRU HULL (Option: Generator)	1	EA
15	71003	1IN SS THRU HULL BARB (Option: Macerator)	1	EA
16	71006	1 1/2IN SS THRU HULL BARB (Aft Stb Liner Drain)	1	EA
17	B-01336	LG. SS RUBRAIL END CAP	1	PR
18	71004	1 1/8IN SS THRU HULL BARB (Aft Bilge Drain)	1	EA
19	STA75#270CNRS	S270 STBD PREBENT CORNER	1	EA
20	71006	1 1/2IN SS THRU HULL BARB (Forward Liner Drain)	1	EA
21	064A	PORT VENT	1	EA
21a	VHF-3WS	3 IN. SAND FLANGE	3	EA
22	STA75#270CNRP	S270 PORT PREBENT CORNER	1	EA
23	71006	1 1/2IN SS THRU HULL BARB (Aft Port Liner Drain)	1	EA
24	71002	3/4IN SS THRU HULL BARB (Cockpit Galley Sink Drain)	1	EA
25	71004	1 1/8IN SS THRU HULL BARB (Anchor Locker Drain)	1	EA
26	STA75181.75	3/4X.062 81 3/4 STAINLESS	1	EA
27	6356P1	TRANSOM LIGHT W/PACK.PLUG	1	EA
28	2264	2 1/2 SS LIFT HANDLE LOCK	1	EA
28a	SL50BP3-1	90 DEGREE BRACKET-BLACK	1	EA
28b	SL40BP3-1	FLAT BRACKET-BLACK	1	EA
28c	SL13-30-1	30LB GAS SHOCK 15IN EXT. 36 STD PAC	1	EA
28d	CHRG25MF	25 FEET COAXIAL W/F MALE-FEMALE	1	EA
29	3-1180	S270 TRUNK LID	1	EA
29a	2340-1209	HINGE 3.187 IN X 1.5 IN	2	EA
29b	3-1194	S270 TRUNK TUB	1	EA
30	35294	S270 TRANSOM GRAB RAIL	1	EA
31	35231	RAIL- FWD MOTOR BOX LID 220SSI	1	EA
32	U13772-01	DANGER USING BOARDING LADDER LABEL	1	EA
33	PS-9	21 3/4 PLATFORM BRACE(50)	2	EA
34	CH14X11.5XDSNS	14 X 11.5 TRIM TAB W/BULLET CONN. W	1	SET
35	U15925-01	SWIM PLATFORM LABEL	1	EA
36	PS-12	32 IN. PLATFORM BRACE(50)	1	EA
37	714-1-PLB	DRAIN PLUG(50)	1	EA
38	U16852-01	WINTERIZED LABEL	1	EA
39	STA75I178	3/4X.062 178" STAINLESS	1	EA
40	STA75I68.5	68.5IN. SS INSERT	1	EA

Parts Not Pictured Which Are Associated With Hull Deck Exterior:

Not Pictured	71002	3/4IN SS THRU HULL BARB (Sump pump drain)	1	EA
Not Pictured	8104	S270 ANCHOR CHAFE PLATE	1	EA

NOTE: Numbers with letter designations represent parts included with primary numbered part for which there is no photo representation.

PARTS IDENTIFICATION GUIDE

SIGNATURE 270

2004 MODEL YEAR

Graphics



PARTS IDENTIFICATION GUIDE

SIGNATURE 270

2004 MODEL YEAR

Graphics

Item No.	Part Number	Description	Qty.	U.O.M.
1	U13675-02	SIGNATURE NAME	2	EA
2	QMI-215203	LARGE CHROME DESIGNATOR	4	EA
3	U15542-02	BIRD HEAD LOGO (BLUE) BLUE BACK/ EM	2	EA
4	U18893-01	270 SIGNATURE DESIGNATOR	2	EA
5	QMI-215201	CHAPARRAL CHROME LETTERS	2	EA
6	QMI-215204	CHAPARRAL CHROME BIRD LOGO	2	EA
7	U13656-02	EXTENDED V-HULL DECAL BLUE BACK/EMB	1	EA
8	U18693-01	PROT. DESIGN DECAL- 2002	1	EA
Not Pictured	14-00043	DECAL - 5 YEAR WARRANTY/CSI AWARD WS LABEL	1	EA
Not Pictured	14-00051	LABEL - BOAT AND YACHT NMMA	1	EA

WHITE BOATS W/CHAMPAGNE INTERIOR

9	U16782-02	SIGN. HULL GRAPHIC GOLD	1	SET
10	U16780-03	SIGN. HULL STRIPE GOLD	55	FT
11	U16781-03	SIGN DECK STRIPE GOLD (BLACK) LT. G	47	FT

WHITE BOATS W/PLATINUM INTERIOR

9	U16782-01	SIGN. HULL GRAPHIC PEWTER	1	SET
10	U16780-02	SIGN. HULL STRIPE BLACK MAGNESIUM (55	FT
11	U16781-02	SIGN DECK STRIPE BLACK (BLACK)/PEWT	47	FT

WIDE BAND GEL COAT BLACK/CHAMPAGNE INTERIOR

9	U19990-01	SIG HULL FLARE/ OYSTER	1	SET
10	U19991-01	SIG HULL STRIPE/ OYSTER	55	FT
11	U16781-07	SIG DECK STRIPE BLK/OYST	47	FT

WIDE BAND GEL COAT BLACK/PLATINUM INTERIOR

9	U19990-02	SIG WIDEBAND FLARE SIVER	1	SET
10	U19991-02	SILVER SIG HULL STRIPE	55	FT
11	U16781-10	SIG DECK STRIPE SIL/BLK	47	FT

WIDE BAND GEL COAT BLUE/CHAMPAGNE INTERIOR

9	U19990-01	SIG HULL FLARE/ OYSTER	1	SET
10	U19991-01	SIG HULL STRIPE/ OYSTER	55	FT
11	U16781-06	SIG DECK STRIPE BL/OYSTER	47	FT

WIDE BAND GEL COAT BLUE/PLATINUM INTERIOR

9	U19990-02	SIG WIDEBAND FLARE SIVER	1	SET
10	U19991-02	SILVER SIG HULL STRIPE	55	FT
11	U16781-09	SIG DECK STRIPE SIL/BLUE	47	FT

WIDE BAND GEL COAT BURGUNDY/CHAMPAGNE INTERIOR

9	U19990-01	SIG HULL FLARE/ OYSTER	1	SET
10	U19991-01	SIG HULL STRIPE/ OYSTER	55	FT
11	U16781-08	SIG DECK STRIPE BG/OYSTER	47	FT

WIDE BAND GEL COAT BURGUNDY/PLATINUM INTERIOR

9	U19990-02	SIG WIDEBAND FLARE SIVER	1	SET
10	U19991-02	SILVER SIG HULL STRIPE	55	FT
11	U16781-11	SIG DECK STRIPE SIL/BURG	47	FT

PARTS IDENTIFICATION GUIDE

SIGNATURE 270

2004 MODEL YEAR

Forward Cabin

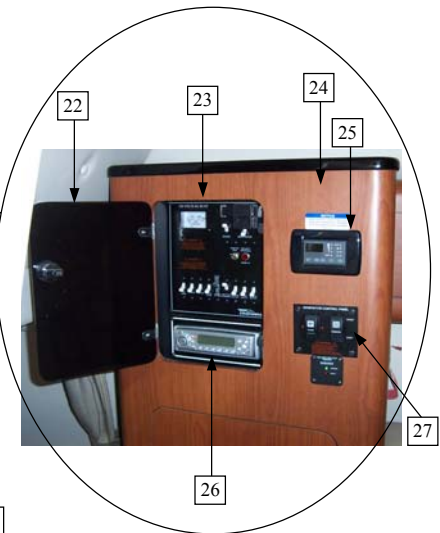
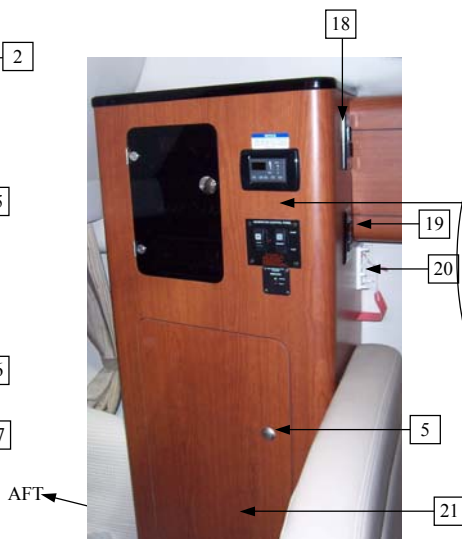
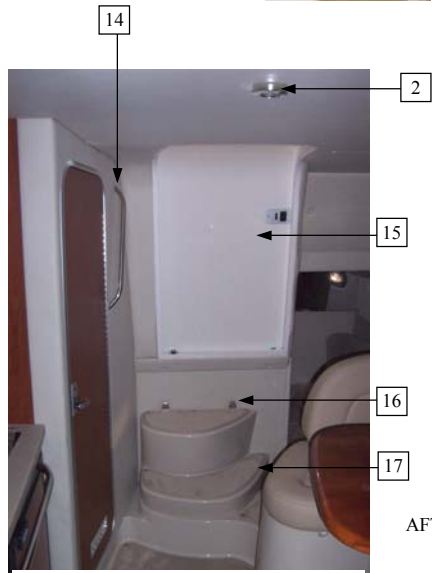

PARTS IDENTIFICATION GUIDE

SIGNATURE 270

2004 MODEL YEAR

Forward Cabin

Item No.	Part Number	Description	Qty.	U.O.M.
1	8268-14-B.AM	HALOGEN LIGHT W/ AMP BULLET CONNECT	2	EA
2	29002355	10W ROUND HALOGEN LIGHT	8	EA
2a	03001009	CHROME TRIM RING/30740110	8	EA
2b	1651H-32BZL	CHROME STANF OFF/30740110	8	EA
3	402642CAB	STBD V-BERTH UPPER SIDE SHELF	1	EA
3a	488-006504109	S270 STARBOARD SIDE TRIM	1	EA
4	402638CAB	FORWARD V-BERTH DRAWER BOX ASSEMBLY	1	EA
4a	423.35.366	14" WHITE DRAWER RUNNER (Forward V-Berth Drawer Box)	1	PR
5	229.11.215	ROSSETTE/ NICKEL MATT	4	EA
5a	239.41.013	STRIKE PLATE .40X12MM	4	EA
5b	229.10.220	KNOB/ NICKEL MATT	4	EA
5c	211.60.609	LOCK MECHANISM	4	EA
6	75359-83	27 1/2 LEGS	2	EA
6a	75359-84	11 1/2 LEGS	1	EA
7	2701	270 SIG DINNETTE TABLE MAPLE W/ STA	1	EA
7a	2702	270 DINNETTE TABLE BRACE	1	EA
7b	75354	TABLE BASE	2	EA
8	402643CAB	PORT V-BERTH UPPER SIDE SHELF	1	EA
8a	588-006504108	S270 PORT SIDE TRIM	1	EA
9	402647CAB	LARGE DOOR (Port Dinette Cabinet)	2	EA
9a	18524	120 DEGREE NO DOWELS (Large Door)	4	EA
10	402646CAB	PORT DINETTE CABINET	1	EA
11	224102	240/260 PILLOW PACKAGE (Option: Accessory Pkg)	1	SET
12	270502	270 SLIDER DOOR W/SCREEN (Option: Sliding Door With Screen)	1	EA
13	270500	270SIG COMPANION WAY TRIM	1	EA
14	53122-1.5	GRAB RAIL 22 IN. OVAL	1	EA
15	270501	270SIG SLIDING DOOR	1	EA
15a	935	CHROME WINDOW STOP	1	EA
16	2340-1209	HINGE 3.187 IN X 1.5 IN (Cabin Steps)	2	EA
16a	4031	LEG HINGE (BLK (90) F (Cabin Steps)	1	EA
16b	35166	S270 CABIN STEP BRACE (Cabin Steps)	1	EA
17	3-1176	S270 CABIN STEPS	1	EA
18	220-00433-A	BLK GFCI ASSY W/18IN PIG (Part of AC Kit)	1	EA
18a	700-IACP26BX	BLACK DECORATIVE COVER (Part of AC Kit)	1	EA
19	700-5601BLK	LEVITON LIGHT SWITCH-BLK (Part of AC Kit)	1	EA
19a	700-IACP26BX	BLACK DECORATIVE COVER (Part of AC Kit)	1	EA
20	CMD-3M-C	CARBON MONOXIDE DETECTOR	1	EA
21	402645CAB	DINETTE HANGING LOCKER DOOR	1	EA
21a	90110	165 DEGREE HINGE NO DOWEL (Dinette Hanging Locker Door)	6	EA
22	588-1065042	S270 AC/DC DOOR PANEL	1	EA
23	CH01P280AC1-2	280 AC PANEL W/GENERATOR (Part of AC Kit)	1	EA
24	402644CAB	DINETTE HANGING LOCKER	1	EA
24a	588-006504105	S270 U-SHAPE TRIM	1	EA
24b	2433P	30A GALVANIC ISOLATOR (Inside Dinette Cabinet)	1	EA
25	222000210	DISPLAY ONLY ELITE I/O PASSPORT (Option: Air Conditioner)	1	EA
25a	U17407-01	WHEN USE A/C SUMP BRKR ON (Option: Air Cond.)	1	EA
26	MR-16	JBL STEREO/CD PLAYER	1	EA
26a	MCDC-100	JBL 6 DISC CHANGER (Option: JBL CD Changer)	1	EA
26b	SEA-ANT	JVC ANTENNA	1	EA
26c	SEA-STRAP	8 IN. SUPPORT STRAP	1	EA
26d	200-00028	STEREO FACEPLATE	1	EA
27	221-03907-P	S270/310/350 GEN. PANEL (Option: Generator)	1	EA

Parts Not Pictured Which Are Associated With Forward Cabin:

Not Pictured	IST12295SD	S270 DINETTE HATCH (Floor Lid Storage)	1	EA
Not Pictured	JBLMS610BB	6 1/2IN BLK JBL SPEAKER	2	EA
Not Pictured	700-5634ESP	LEVITON DUAL LIGHT SW BLK (Aft Side of Dinette Cabinet) (Part of AC Kit)	1	EA
Not Pictured	700-IACP26BX	BLACK DECORATIVE COVER (Aft Side of Dinette Cabinet) (Part of AC Kit)	1	EA
Not Pictured	SL34-40-1	40LB GAS SHOCK (Bunk Storage)	2	EA
Not Pictured	SL50BP3-1	90 DEGREE BRACKET-BLACK (Bunk Storage)	4	EA
Not Pictured	GROUPER	FISH ANODE	1	EA
Not Pictured	402639CAB	FORWARD V-BERTH DRAWER BOX	1	EA
Not Pictured	402640CAB	FORWARD V-BERTH DRAWER BOX FACE	1	EA
Not Pictured	402641CAB	FORWARD V-BERTH DRAWER BOX DRAWER	1	EA

PARTS IDENTIFICATION GUIDE

SIGNATURE 270
2004 MODEL YEAR

Alternating Current Electrical System

Part Number	Description	Qty.	U.O.M.
209-00063-A	S270 120V AC KIT	1	KIT
205-00061-A	S290/270 120V AC PANEL (Option: 120V AC Kit)	1	EA
220-00433-A	BLK GFCI ASSY W/18IN PIG (Option: 120V AC Kit)	1	EA
700-IACP26BX	BLACK DECORATIVE COVER (Option: 120V AC Kit)	3	EA
220-02182-H	S270 GALLEY AC HRNSS (Option: 120V AC Kit)	1	EA
220-00331-A	WHITE GFCI ASSEMBLY (Option: 120V AC Kit)	1	EA
700-4998W	WHITE WEATHER PROOF COVER (Option: 120V AC Kit)	1	EA
220-03650-P	AC SHORE INLET PANEL (Option: 120V AC Kit)	1	EA
220-02179-H	S270 WATER HEATER HARNESS (Option: 120V AC Kit)	1	EA
220-02180-H	S270 SHORE POWER (Option: 120V AC Kit)	1	EA
220-02181-H	S270 GENERATOR AC HRNS (Option: 120V AC Kit)	1	EA
220-02183-H	S270 COCKPIT HARNESS (Option: 120V AC Kit)	1	EA
220-02189-H	S270 BATT CHRG AC HRNSS (Option: 120V AC Kit)	1	EA
220-02190-H	S270 HEAD HRNSS W/GFI W/P COVER (Option: 120V AC Kit)	1	EA
220-00332-A	WHITE DECORATIVE RECEPT. RECEPT ASS (Option: 120V AC Kit)	1	EA
220-00364-A	BLK DECORATIVE RECEPT ASY (Option: 120V AC Kit)	1	EA
220-00432-A	BLK RECEPT W/SHALLOW BOX (Option: 120V AC Kit)	1	EA
700-IACP26WX	WHITE DECORATIVE COVER (Option: 120V AC Kit)	1	EA

209-00032-A	S270 220V AC KIT	1	KIT
220-03242-P	280SIG 220V AC PNL W/GEN (Option: 220V AC Kit)	1	EA
220-03650-P	AC SHORE INLET PANEL (Option: 220V AC Kit)	1	EA
220-02179-H	S270 WATER HEATER HARNESS (Option: 220V AC Kit)	1	EA
220-02180-H	S270 SHORE POWER (Option: 220V AC Kit)	1	EA
220-02181-H	S270 GENERATOR AC HRNS (Option: 220V AC Kit)	1	EA
220-02182-H	S270 GALLEY AC HRNSS (Option: 220V AC Kit)	1	EA
220-02183-H	S270 COCKPIT HARNESS (Option: 220V AC Kit)	1	EA
220-02189-H	S270 BATT CHRG AC HRNSS (Option: 220V AC Kit)	1	EA
203-00090-A	S270 HEAD HRN W/WEAT. VIM (Option: 220V AC Kit)	1	EA
220-00332-A	WHITE DECORATIVE RECEPT. (Option: 220V AC Kit)	1	EA
700-IACP26WX	WHITE DECORATIVE COVER (Option: 220V AC Kit)	1	EA
220-00334-A	220V STD. VIMAR OUTLET (Option: 220V AC Kit)	2	EA
220-00335-A	220V WEATHER PROOF VIMAR (Option: 220V AC Kit)	1	EA
220-03939-P	SGL GALVANIC ISOLATOR PNL (Option: 220V AC Kit)	1	EA
20-6506	TV CLOSEOUT (Option: 220V AC Kit)	1	EA
MI630N-K	6 CU. FT. MICROWAVE 220V (Option: 220V AC Kit)	1	EA
HBL61CM08W	50FT. CABLE 125V (LOT 3) (Option: 220V Ac Kit)	1	EA
B40518	EURO 1BURNER ELECTRIC 220 (Option: 220V AC Kit)	1	EA
HBL316NM	POWER INLET PLUG INTERNAT (Option: 220V AC Kit)	1	EA
HBL316CSW	50 FT. WHITE CABLE 230V (Option: 220V AC Kit)	1	EA
F650	6GL 220V HOT WATER HEATER (Option: 220V AC Kit)	1	EA

PARTS IDENTIFICATION GUIDE

SIGNATURE 270

2003 MODEL YEAR

Aft Cabin



INSIDE AFT CABIN FACING AFT/PORT CORNER

PORT

PARTS IDENTIFICATION GUIDE

SIGNATURE 270

2004 MODEL YEAR

Aft Cabin

Item No.	Part Number	Description	Qty.	U.O.M.
1	29002355	10W ROUND HALOGEN LIGHT	5	EA
1a	03001009	CHROME TRIM RING/30740110	5	EA
1b	1651H-32BZL	CHROME STANF OFF/30740110	5	EA
1c	220-02196-H	AFT CAB OVHEAD LIGHT HRNS	1	EA
2	JB315SSCH	3 X 15 ELIPT. PORT WINDOW	1	EA
3	U16817-01	WINDOW WARNING LABEL	1	EA

Parts Not Pictured Which Are Associated With Aft Cabin:

Not Pictured	402649CAB	AFT STORAGE BOX ASSEMBLY	1	EA
Not Pictured	402651CAB	AFT STORAGE BOX FACE (Part of Aft Storage Box Assembly)	1	EA
Not Pictured	402650CAB	AFT STORAGE BOX (Part of Aft Storage Box Assembly))	1	EA
Not Pictured	803.03.700	WARDROBE TUBE SUPPORT (Part of Aft Storage Box Assembly)	2	EA
Not Pictured	801.23.700	WARDROBE TUBE 19X2500MM (Part of Aft Storage Box Assembly))	1	EA
Not Pictured	402652CAB	AFT STORAGE BOX DOOR (Part of Aft Storage Box Assembly))	1	EA
Not Pictured	90110	165 DEGREE HINGE NO DOWEL (Part of Aft Storage Box Assembly))	2	EA
Not Pictured	229.11.315	ROSSETTE/ NICKEL MATT (Part of Aft Storage Box Assembly))	1	EA
Not Pictured	239.41.013	STRIKE PLATE .40X12MM (Part of Aft Storage Box Assembly))	1	EA
Not Pictured	229.10.320	KNOB/ NICKEL MATT (Part of Aft Storage Box Assembly))	1	EA
Not Pictured	211.60.609	LOCK MECHANISM (Part of Aft Storage Box Assembly))	1	EA

NOTE: Numbers with letter designations represent parts included with primary numbered part for which there is no photo representation.

PARTS IDENTIFICATION GUIDE

SIGNATURE 270

2004 MODEL YEAR

Galley

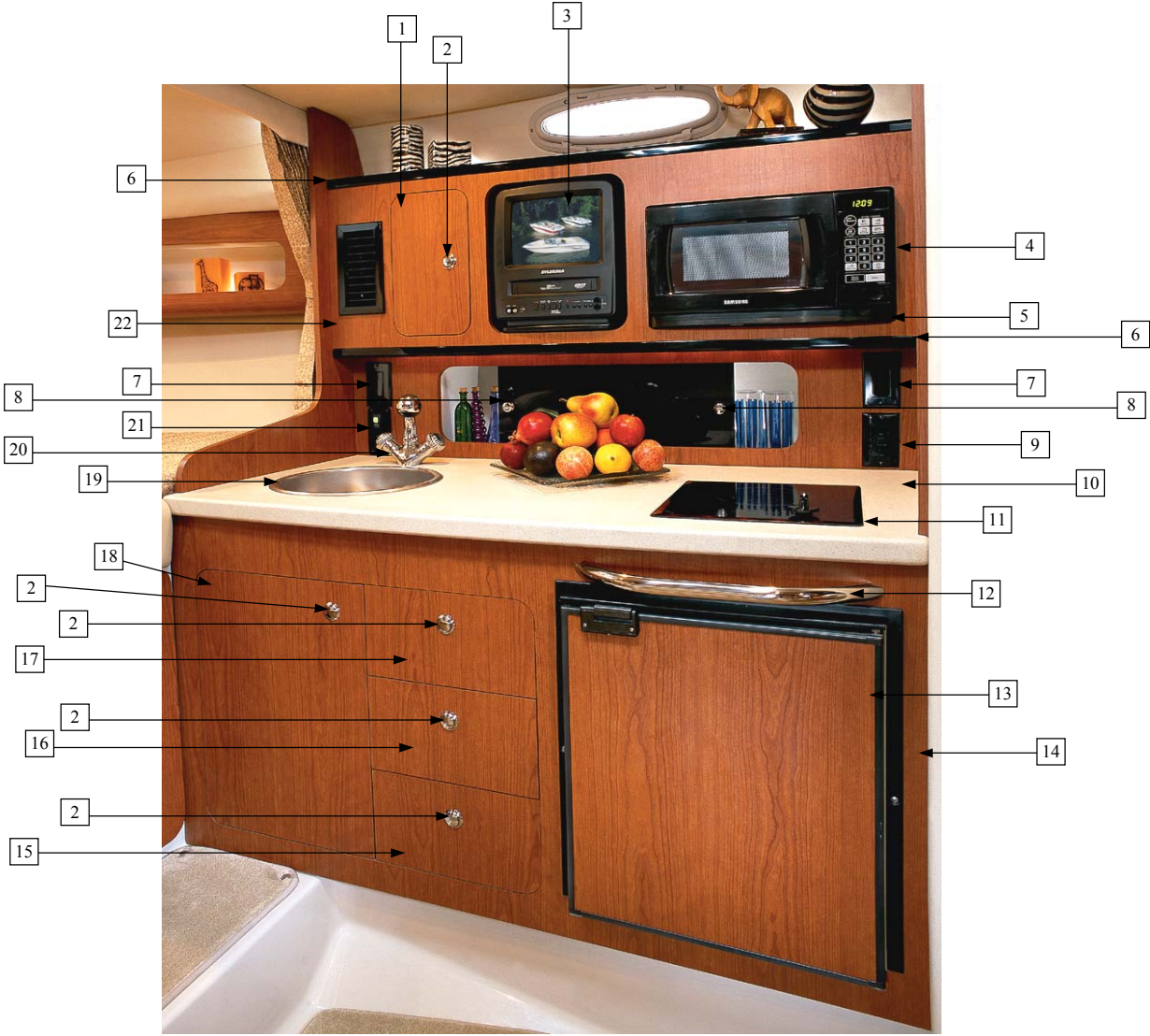

PARTS IDENTIFICATION GUIDE

SIGNATURE 270

2004 MODEL YEAR

Galley

Item No.	Part Number	Description	Qty.	U.O.M.
1	402637CAB	MICROWAVE/TV CABINET DOOR	1	EA
1a	90110	165 DEGREE HINGE NO DOWEL (Microwave/TV Cabinet)	2	EA
2	229.11.215	ROSSETTE/ NICKEL MATT	5	EA
2a	229.10.220	KNOB/ NICKEL MATT	5	EA
2b	211.60.609	LOCK MECHANISM	5	EA
2c	239.41.013	STRIKE PLATE .40x12mm	5	EA
3	TV/DVD	SYLVANIA 9 IN. TV/DVD	1	EA
3a	IST12290B	TV HOLDER	1	EA
3b	RS151247	MINI TV A/B SWITCH	1	EA
3c	RV74	MAGNADYNE H ANTENNA	1	EA
3d	CHRG14MM	14 INCH COAX MALE X MALE	1	EA
3e	20-6506	TV CLOSEOUT (Option: Int'l & CE Pkg)	1	EA
4	MW650BA	6 CU FT MICROWAVE	1	EA
4a	MI630N-K	6 CU FT MICROWAVE 220V (Option: Int'l & CE Pkg)	1	EA
5	IST12286B	MICROWAVE BOARD-2002	1	EA
6	1734-018-BLK	7/8 BLK EDGE BAND (1200')	26	LFT
7	700-5601BLK	LEVITON LIGHT SWITCH-BLK(Part of Panel Kit)	2	EA
7a	700-IACP26BX	BLACK DECORATIVE COVER (Part of Panel Kit)	2	EA
7b	700-HADUBOX	BLUE RECEPT BOX (Part of Panel Kit)	2	EA
8	588-1065043	S270 PLEX SLIDE DOOR KIT	1	EA
9	220-00364-A	BLK DECORATIVE RECEPT ASY (Part of Panel Kit)	1	EA
10	402631CAB	GALLEY COUNTER TOP	1	EA
11	B40517	110 V ELEC STOVE 1 BURNER	1	EA
11a	B40518	EURO 1BURNER ELECTRIC 220 (Option: Int'l & CE Pkg)	1	EA
12	35167	S270 GALLEY RAIL	1	EA
13	DC65URCFGB	DC65 AC/DC R-SWING CHERRY	1	EA
13a	220-00432-A	BLK RECEPT W/SHALLOW BOX (Part of Panel Kit)	1	EA
14	402630CAB	GALLEY	1	EA
15	402635CAB	GALLEY LOWER DRAWER	1	EA
15a	423.35.366	14" WHITE DRAWER RUNNER (Galley Lower Drawer)	1	EA
16	402634CAB	GALLEY MIDDLE DRAWER	1	EA
16a	423.35.419	16" WHITE DRAWER RUNNER (Galley Middle Drawer)	1	PR
17	402633CAB	GALLEY TOP DRAWER	1	EA
17a	423.35.419	16" WHITE DRAWER RUNNER (Galley Top Drawer)	1	PR
18	402632CAB	GALLEY DOOR	1	EA
19	10244	S300 S/S SINK	1	EA
19a	10313	DRAIN W/BASKET STRAINER (Sink Drain)	1	EA
19b	655010XFBB	BLK 8 WASTE ARM HL W/FIB (Sink Drain)	1	EA
19c	141-1120	1 1/2 IN MULTIFLEX-BLACK (Sink Drain)	3.50	FT
20	97655CP	PORTOFINE DUAL FAUCET	1	EA
21	220-03906-P	S270 WATER PRESS/PWR PLUG (Part of Panel Kit)	1	EA
22	402636CAB	MICROWAVE/TV CABINET	1	EA

Parts Not Pictured Which Are Associated With Galley:

Not Pictured	SFT012-TC-42-MLX/A	42" SOFT TOUCH LIGHT	1	EA
Not Pictured	B92004	S300 SEA RAIL KIT SINGLE BURNER	1	EA
Not Pictured	81932-C	3IN. GRILL CURVED CHROME	3	EA
Not Pictured	220-03909-P	S270 POWER PLUG PANEL (Part of Panel Kit)	1	EA
Not Pictured	U17402-01	WARNING UNSECURED ITEMS	1	EA
Not Pictured	571.52.208	VENTILATION GRILL PL CHR	1	EA
Not Pictured	400247	SINK LID	1	EA

NOTE: Numbers with letter designations represent parts included with primary numbered part for which there is no photo representation.

PARTS IDENTIFICATION GUIDE

SIGNATURE 270
2004 MODEL YEAR

Head



PARTS IDENTIFICATION GUIDE

SIGNATURE 270

2004 MODEL YEAR

Head

Item No.	Part Number	Description	Qty.	U.O.M.
1	3-1177	S270 HEAD	1	EA
2	U17220-01	NOTICE BEFORE DUMPING	1	EA
3	81932-C	3IN. GRILL CURVED CHROME	1	EA
4	29090-2001	MANUAL TOILET LH	1	EA
4a	104-1120	1 1/2 SANITATION HOSE (Toilet to Waste Tank)	7	FT
5	270503	270SIG HEAD ACCESS DOOR	1	EA
6	M1-63-8	LATCH/FLUSH SS(5000 MIN)	1	EA
7	220-03908-P	S270 HEAD PNL W/WASTE IND (Part of Panel Kit)	1	EA
7a	221-02186-H	S270 HEAD HARNESS (Part of Panel Kit)	1	EA
8	35265	280SIG UP HEAD KEEP RAIL	1	EA
9	6424	S300 HEAD DOOR RING	1	EA
10	402825CAB	280 SIG HEAD DOOR	1	EA
10a	CB15072-A	6FT ALUM. HINGE	1	EA
10b	4-1086	2004 LG. HEAD DOOR MIRROR 1/4"	1	EA
10c	305-5808-1/4	1/4" PLASTIC MIRROR CLIP	4	EA
11	U13767-01	WARNING OPEN DOORS MAY	1	EA
12	85111	RIGHT HAND OUT HEAD DOOR	1	EA
13	571.52.208	VENTILATION GRILL PL.CHR.	2	EA
13a	4481-701	VENTILATION DECAL	1	EA
14	53122-1.5	GRAB RAIL 22 IN. OVAL	1	EA
15	000001RM	1/4IN X 20IN ROUND MIRROR	1	EA
16	305-5808-1/4	1/4 PLASTIC MIRROR CLIPS	4	EA
17	U13777-01	NOTICE USING SHOWER LABEL	1	EA
18	97655CP	PORTOFINE DUAL FAUCET	1	EA
19	32100020	OVAL SINK	1	EA
19a	65SPR1303	1-1/4 X 5 LAV. DRAIN (Sink Drain)	1	EA
19b	141-1140	1 1/4 IN. MULTIFLEX (Sink Drain)	1.50	FT
20	H-128	16IN. GRABRAIL(100)	1	EA

Parts Not Pictured Which Are Associated With Head:

Not Pictured	30740110	10WATT HALOGEN LGT W/LENS	2	EA
Not Pictured	03001009	CHROME TRIM RING/30740110	2	EA
Not Pictured	CB-4W	4.5IN WHITE MTR WELL BOOT	1	EA
Not Pictured	1733-1	3IN. TURBO BILGE BLOWER24 (Head Ventilation)	1	EA
Not Pictured	402-3000	3 IN.BLOWER/VENT HOSE-BLK (Head Ventilation)	1.50	FT
Not Pictured	1178-KTS	KHAKI TOWEL SET (Option: Accessory Pkg)	2	SET
Not Pictured	31000060	BRONZE PLEX DOOR	1	EA

NOTE: Numbers with letter designations represent parts included with primary numbered part for which there is no photo representation.

Parts Identification Guide

Signature 270
2004 Model Year

Air Conditioning



AIR CONDITIONING SYSTEM IN V-BERTH

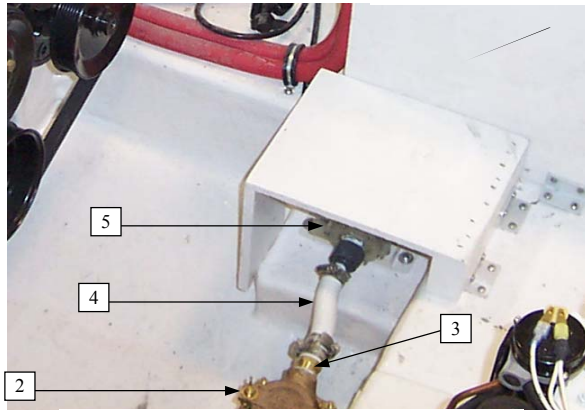

AIR CONDITIONING SYSTEM IN ENGINE WELL



THERMOSTAT IN DINETTE CABINET



8

VENTILATION COVERS IN FORWARD CABIN



9

PARTS IDENTIFICATION GUIDE

SIGNATURE 270

2004 MODEL YEAR

Air Conditioning

Item No.	Part Number	Description	Qty.	U.O.M.
1	CHA270-04	S270 AIR COND KIT 110V (Option: 110V Air Conditioner)	1	EA
1a	220-02188-H	S270 A/C HRNSS (Option: 110V Air Conditioner)	1	EA
2	493-5	3/4 WATER STRAINER (1990) (Option: 110V Air Conditioner)	1	EA
2a	L567205	3/4 BRONZE THRU HULL (Option: 110V Air Conditioner)	1	EA
2b	78-115-01	3/4 BRONZE SEA FLANGE (Option: 110V Air Conditioner)	1	EA
2c	65-007-51	3/4 PIPE HOSE ADAPTER (Option: 110V Air Conditioner)	1	EA
3	DBN66	3/4MPT 3/4HBB BRS CPL (Option: 110V Air Conditioner)	2	EA
4	100-0340	3/4 HARDWALL WATER HOSE (Option: 110V Air Conditioner)	1	FT
5	225500201	PUMP PML250 115V 3/4NYLON (Option: 110V Air Conditioner)	1	EA
5a	220-02187-H	S270 A/C PUMP HRNSS (Option: 110V Air Conditioner)	1	EA
6	U13775-01	NOTICE AIR CONDITIONER SHORE POWER (Option: 110V Air Conditioner)	1	EA
7	222000210	DISPLAY ELITE I/O PASSPOR (Option: 110V Air Conditioner)	1	EA
7a	700-TP13W	BLANK OUTLET COVER (Option: 110V Air Conditioner)	1	EA
7b	700-HADUBOX	BLUE RECEIPT BOX (Option: 110V Air Conditioner)	1	EA
8	217000534	11X8TRAF MF PNTD BLACK (Option: 110V Air Conditioner)	1	EA
9	217000501	8X4TV MF PNTD GLOSS BLACK (Option: 110V Air Conditioner)	1	EA

Parts Not Pictured Which Are Associated With Air Conditioning:

Not Pictured	222102307	SNSR AIR 7EC/PS/MX W/CLP (Option: 110V Air Conditioner)	1	EA
Not Pictured	222103005	CABLE DISPLAY 20'ECU 8PIN (Option: 110V Air Conditioner)	1	EA
Not Pictured	226000006	HOSE W/WATER 5/8 IN WHITE (Option: 110V Air Conditioner)	36	FT
Not Pictured	226600009	DUCT FLEX 3IN. (Option: 110V Air Conditioner)	4	FT
Not Pictured	226600011	DUCT FLEX 5IN. (Option: 110V Air Conditioner)	6	FT
Not Pictured	228700016	RING ABS TRANS 5IN OBLONG (Option: 110V Air Conditioner)	1	EA
Not Pictured	229500060	BOX ABS V7-12-5X5/A3.E5 -DIV70/30-Z (Option: 110V Air Conditioner)	1	EA
Not Pictured	333437	GRILL EURO ROUND 3IN BLAC (Option: 110V Air Conditioner)	1	EA
Not Pictured	335380	ELBOW PVC 1/2MPTX1/2HB 9 (Option: 110V Air Conditioner)	1	EA
Not Pictured	205311314	VCD10K/1-LH HRZ BLWR 115V (Option: 110V Air Conditioner)	1	EA
Not Pictured	335441	BEZEL POLY BACK 4.84X3.23 (Option: 110V Air Conditioner)	1	EA
Not Pictured	301-4A	5/8 IN. PLASTIC THRU-HULL	1	EA
Not Pictured	6708-5	#8 HOSE CLAMP (7/16-1)	14	EA
Not Pictured	71001	5/8IN(1/2IN) SS THRU HULL BARB	1	EA
Not Pictured	906061	SCOOP SCREEN	1	EA
Not Pictured	U13815-01	RAW WATER INLET/AIR CONDITIONER LAB	1	EA
Not Pictured	U17407-01	WHEN USE A/C SUMP BRKR ON	1	EA

NOTE: Numbers with letter designations represent parts included with primary numbered part for which there is no photo representation.

Parts Identification Guide

Signature 270
2004 Model Year

Air Conditioning



AIR CONDITIONING SYSTEM IN V-BERTH

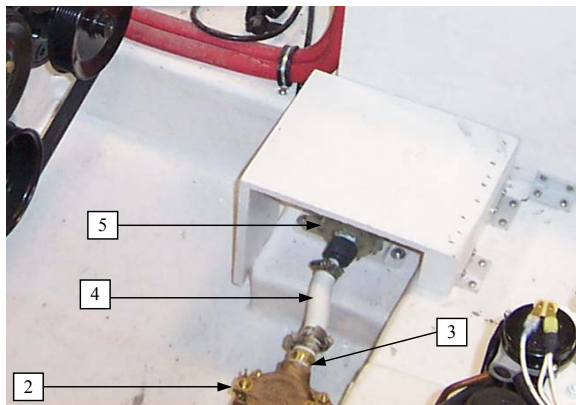

AIR CONDITIONING SYSTEM IN ENGINE WELL



THERMOSTAT IN DINETTE CABINET



VENTILATION COVERS IN FORWARD CABIN



PARTS IDENTIFICATION GUIDE

SIGNATURE 270 2004 MODEL YEAR

Air Conditioning

Not Pictured	CHA270-04Z	S270 AIR COND KIT 220V (Option: 220V Air Conditioner)	1	EA
Not Pictured	205411446	VCD10KZ50/1-LH HRZ 417A 220V (Option: 220V Air Conditioner)	1	EA
Not Pictured	217000501	8X4TV MF PNTD GLOSS BLACK (Option: 220V Air Conditioner)	1	EA
Not Pictured	217000534	11X8TRAF MF PNTD BLACK (Option: 220V Air Conditioner)	1	EA
Not Pictured	222000210	DISPLAY ELITE I/O PASSPOR (Option: 220V Air Conditioner)	1	EA
Not Pictured	222102307	SNSR AIR 7'EC/PS/MX W/CLP (Option: 220V Air Conditioner)	1	EA
Not Pictured	222103005	CABLE DISPLAY 20'ECU 8PIN (Option: 220V Air Conditioner)	1	EA
Not Pictured	225500203	PUMP PML250 230V 3/4NYLON (Option: 220V Air Conditioner)	1	EA
Not Pictured	226000006	HOSE W/WATER 5/8 IN WHITE (Option: 220V Air Conditioner)	36	FT
Not Pictured	226600009	DUCT FLEX 3IN. (Option: 220V Air Conditioner)	4	FT
Not Pictured	226600011	DUCT FLEX 5IN. (Option: 220V Air Conditioner)	6	FT
Not Pictured	228700016	RING ABS TRANS 5IN OBLONG (Option: 220V Air Conditioner)	1	EA
Not Pictured	229500060	BOX ABS V7-12-5X5/A3.E5 -DIV70/30-Z (Option: 220V Air Conditioner)	1	EA
Not Pictured	333437	GRILL EURO ROUND 3IN BLAC (Option: 220V Air Conditioner)	1	EA
Not Pictured	335380	ELBOW PVC 1/2MPTX1/2HB 9 (Option: 220V Air Conditioner)	1	EA
Not Pictured	100-0340	3/4 HARDWALL WATER HOSE (Option: 220V Air Conditioner)	1.75	FT
Not Pictured	100-0340	3/4 HARDWALL WATER HOSE (Option: 220V Air Conditioner)	1	FT
Not Pictured	220-02187-H	S270 A/C PUMP HRNSS (Option: 220V Air Conditioner)	1	EA
Not Pictured	220-02188-H	S270 A/C HRNSS (Option: 220V Air Conditioner)	1	EA
Not Pictured	301-4A	5/8 IN. PLASTIC THRU-HULL (Option: 220V Air Conditioner)	1	EA
Not Pictured	493-5	3/4 WATER STRAINER (1990) (Option: 220V Air Conditioner)	1	EA
Not Pictured	6708-5	#8 HOSE CLAMP (7/16-1) (Option: 220V Air Conditioner)	14	EA
Not Pictured	700-HADUBOX	BLUE RECEIPT BOX (Option: 220V Air Conditioner)	1	EA
Not Pictured	700-TP13W	BLANK OUTLET COVER (Option: 220V Air Conditioner)	1	EA
Not Pictured	71001	5/8IN(1/2IN) SS THRU HULL BARB (Option: 220V Air Conditioner)	1	EA
Not Pictured	78-115-01	3/4 BRONZE SEA FLANGE (Option: 220V Air Conditioner)	1	EA
Not Pictured	906061	SCOOP SCREEN (Option: 220V Air Conditioner)	1	EA
Not Pictured	335441	BEZEL POLY BACK 4.84X3.23 (Option: 220V Air Conditioner)	1	EA
Not Pictured	DBN66	3/4MPT 3/4HBB BRS CPL (Option: 220V Air Conditioner)	2	EA
Not Pictured	L567205	3/4 BRONZE THRU HULL (Option: 220V Air Conditioner)	1	EA
Not Pictured	U13775-01	NOTICE AIR CONDITIONER SHORE POWER (Option: 220V Air Conditioner)	1	EA
Not Pictured	U13815-01	RAW WATER INLET/AIR CONDITIONER LAB (Option: 220V Air Conditioner)	1	EA
Not Pictured	65-007-51	3/4 PIPE HOSE ADAPTER (Option: 220V Air Conditioner)	1	EA
Not Pictured	U17407-01	WHEN USE A/C SUMP BRKR ON (Option: 220V Air Conditioner)	1	EA

NOTE: Numbers with letter designations represent parts included with primary numbered part for which there is no photo representation.

PARTS IDENTIFICATION GUIDE

SIGNATURE 270

2004 MODEL YEAR

Dash / Helm

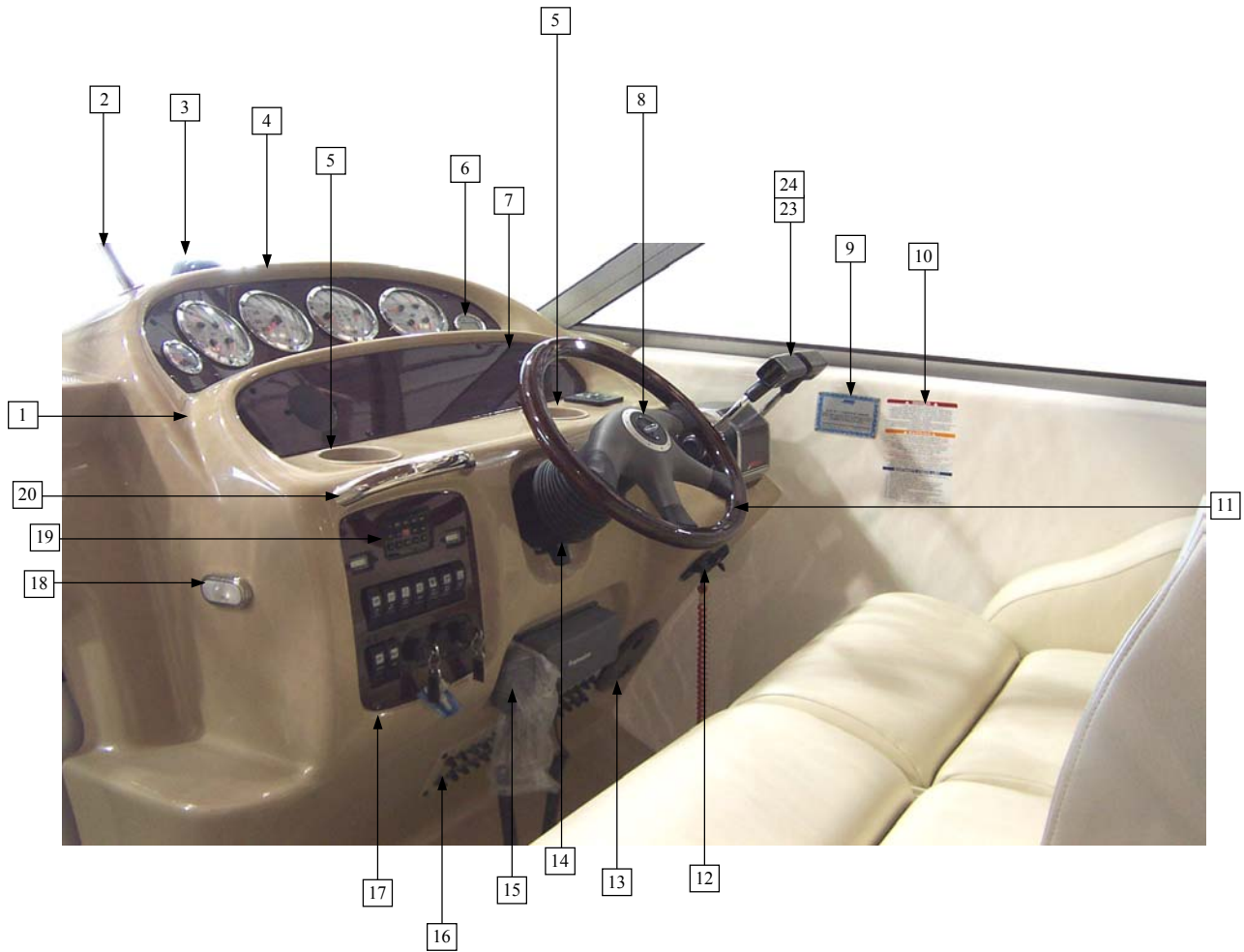

Helm Seat Base

PARTS IDENTIFICATION GUIDE

SIGNATURE 270
2004 MODEL YEAR

Dash / Helm

Item No.	Part Number	Description	Qty.	U.O.M.
1	3-1181	S270 CONSOLE (Champagne Interior)	1	EA
1a	3-1181G	S270 CONSOLE (Platinum Interior)	1	EA
2	35165	S270 WINDSHIELD BRACE	1	SET
3	F-83-C	VOYAGER FLUSH MOUNT CMPSS	1	EA
4	220-03699-P	S270 DE GAUGE PANEL (Part of Panel Kit)	1	EA
4a	63178	4 IN 1 GAUGE (Part of Panel Kit)	1	EA
4b	63173	65 MPH SPEEDO (Part of Panel Kit)	1	EA
4c	63170	TACHOMETER (Part of Panel Kit)	1	EA
4d	63490	FUEL GAUGE (Part of Panel Kit)	1	EA
5	DS-CHTNSBT	D.S. CUPHOLDER TAN WITH TUBE (Champagne Interior)	2	EA
5a	DS-CHLGYSBT	LT. GREY DOUBLE DRINK CUP W/3/8 TUB (Platinum Interior)	2	EA
6	DS0133	DEPTH SOUNDER	1	EA
6a	IS0091	DEPTH SOUNDER INSTRUCTION	1	EA
7	220-03929-P	UPR CNSLE PNL W/O GPS OPT	1	EA
8	U15729-02	STEERING WHEEL DOME 1.625	1	EA
8a	14-00011	STEERING WHEEL DOME 1.42 (Option: Mahogany Steering Wheel)	1	EA
9	YACHT PLATE	YACHT PLATE	1	EA
9a	CH-890	S270 METAL CE PLATE (Option: CE Pkg)	1	EA
10	U17217-01	CO/OPERATOR/BOATMAN COMBO	1	EA
11	MS433515CB	MODEL 43 WHEEL (Champagne Interior)	1	EA
11a	MS433557CB	MODEL 43 GRAY STEERING WHEEL (Platinum Interior)	1	EA
11b	MS6073627CB	MAHOGANY STEERING WHEEL (Option: Mahogany Steering Wheel)	1	EA
11c	61710135251	STEERING WHEEL COVER (Option: Mahogany Steering Wheel)	1	EA
12	KS-22	DUAL I/O SAFETY SWITCH	1	EA
13	DP40-B	4 IN. BLK. PLATE (100BX)	1	EA
14	SH91510	SPLINE TILT MECHANISM	1	EA
14a	SH91523	QUICK CONNECT TILT HELM	1	EA
14b	SSC6216	16 FT. STEERING CABLE	1	EA
15	E43003	RAY 215 VHF RADIO (Option: VHF Radio)	1	EA
15a	M46023	FLUSH MOUNT KIT/VHF215 (Option: VHF Radio)	1	EA
15b	RA1206	8 FT. FIBERGLASS ANTENNA (Option: VHF Radio)	1	EA
15c	6520S	SS ANTENNA MOUNT (Option: VHF Radio)	1	EA
15d	4600W	ANTENNA CLEAT (Option: VHF Radio)	1	EA
15e	2340-840	MIDGET VENT 1 1/2 X 1 3/4 (Option: VHF Radio)	1	EA
16	205-00168-A	S270 CIRCUIT BREAKER PANEL-(Champagne Interior)	1	EA
16a	205-00167-A	S270 CIRCUIT BREAKER PANEL-(Platinum Interior)	1	EA
17	221-03684-P	S270 DE SWITCH PANEL (Part of Panel Kit)	1	EA
17a	CH124	STANDARD TACTILE SWITCH (Trim Tab Switch)	1	EA
18	69350-MLX/A	OBLONG LED COURTESY LIGHT	1	EA
19	JBLREM25B	BLACK REMOTE	1	EA
20	53109-1.5	9 IN RAIL W/ PAD	1	EA
21	3-1197	S270 HELM SEAT TUB	1	EA
22	IST34300	S350 HELM STORAGE KEEPER	1	EA

Parts Not Pictured Which Are Associated With Dash Helm:

Not Pictured	209-00020-B	S270 DE PANEL KIT	1	KIT
Not Pictured	220-01444-H	TRANSOM DRAIN WIRE (Part of Panel Kit)	1	EA
Not Pictured	220-02721-C	Y-REMOTE HARNESS (Part of Panel Kit)	1	EA
Not Pictured	220-02249-H	21FT MERC ENGINE HARNESS (Part of Panel Kit)	1	EA
Not Pictured	220-02248-H	18FT MERC ENGINE HARNESS (Part of Panel Kit)	1	EA
Not Pictured	220-02192-H	GALLEY OVERHEAD LIGHT HRN (Part of Panel Kit)	1	EA
Not Pictured	220-02193-H	DINETTE OVHEAD LIGHT HRNS (Part of Panel Kit)	1	EA
Not Pictured	222-02195-H	S270 FWD CABIN LT HARNESS (Part of Panel Kit)	1	EA
Not Pictured	203-00172-A	S270 DE DISTRIBUTION HARNESS (Part of Panel Kit)	1	EA
Not Pictured	221-02185-H	S270 DC GALLEY LT HARNESS (Part of Panel Kit)	1	EA
Not Pictured	E32015	RAYCHART 320 CHARTPLOTTER (Option: RayNav GPS)	1	EA
Not Pictured	220-03905-P	UPR CNSLE PNL W/GPS OPT (Option: Ray Nav GPS)	1	EA
Not Pictured	R38061	RN300-RC320 FLUSH MOUNT (Option: Ray Nav GPS)	1	EA
Not Pictured	220-00438-A	RAYTHEON 10 WAY FUSEBLOCK	1	EA

NOTE: Numbers with letter designations represent parts included with primary numbered part for which there is no photo representation.

PARTS IDENTIFICATION GUIDE

SIGNATURE 270

2004 MODEL YEAR

Dash / Helm

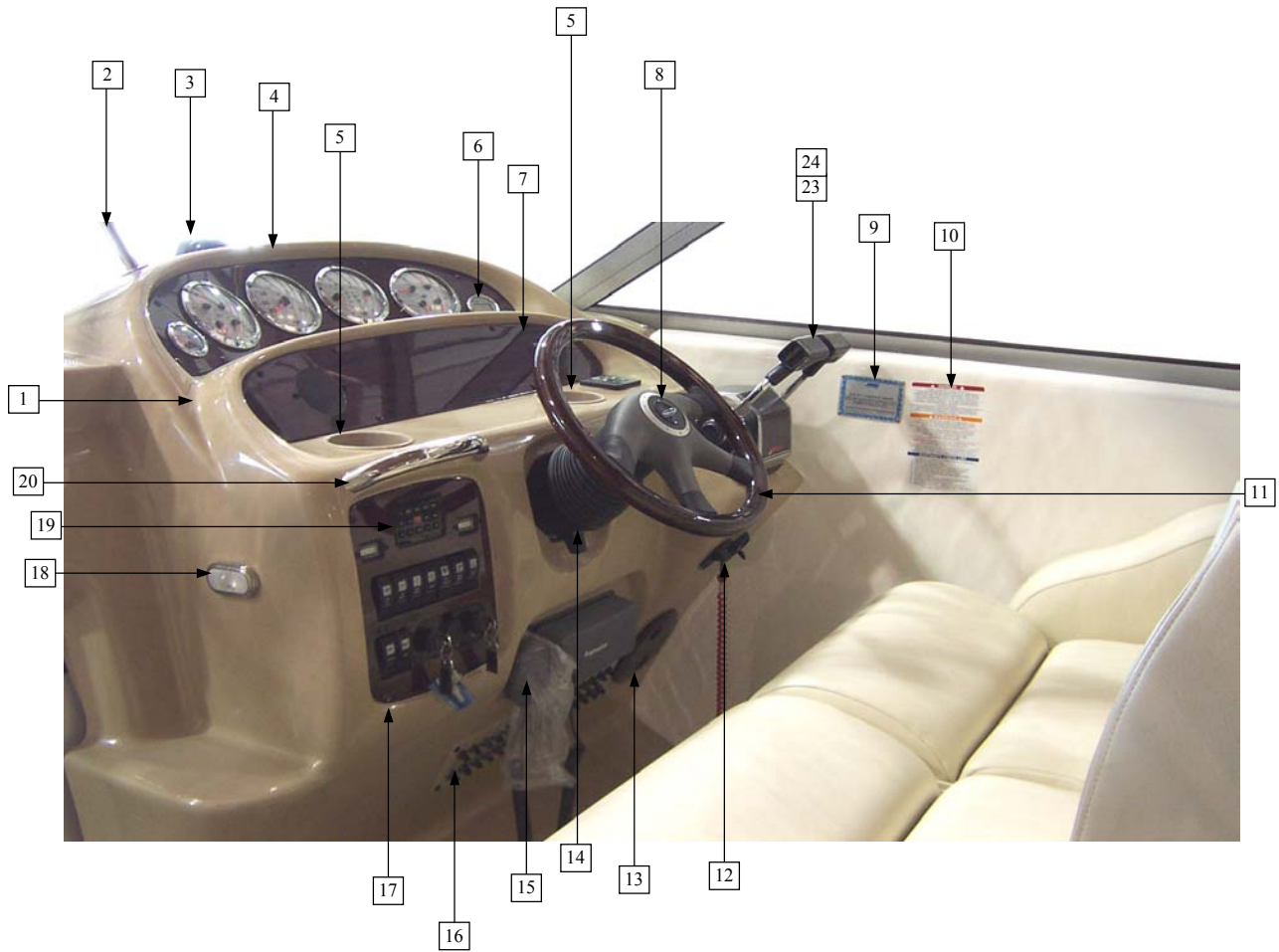

Helm Seat Base

PARTS IDENTIFICATION GUIDE

SIGNATURE 270
2004 MODEL YEAR

Dash / Helm

Item No.	Part Number	Description	Qty.	U.O.M.
23	883711A03	GEN II DUAL BIN CONTROL (Mercruiser Engines)	1	EA
23a	CC67917	TFXTREME GEN II MERC CABLE (Mercruiser Engines)	1	EA
23b	CC67919	TFXTREME GEN II MERC CABLE (Mercruiser Engines)	1	EA
23c	CC67920	TFXTREME GEN II MERC CABLE (Mercruiser Engines)	1	EA
23d	CC67921	TFXTREME GEN II MERC CABLE (Mercruiser Engines)	1	EA
23e	151-0400	4MM PITOT TUBING (Mercruiser Engines)	24	FT
23f	5324K81	SPRING HOSE CLAMP 1/4 IN. (Mercruiser Engines)	1	EA
23g	46974	1/4 ST ELL 90 DEG 28-157S (Mercruiser Engines)	2	EA
23h	DBN32	1/4X3/8 BRASS BARB HOSE (Mercruiser Engines)	2	EA
23i	NC15	15/16IN. INSULATED CLAMP (Mercruiser Engines)	7	EA
23j	6708-5	#8 HOSE CLAMP (7/16-1) (Mercruiser Engines)	2	EA
23k	92020A2	TIE BAR DUAL ENG (Mercruiser Engines)	1	EA
23l	6708-5	#8 HOSE CLAMP (7/16-1) (Mercruiser Engines)	6	EA
23m	KSB-CHAP-0.500	1/2 IN. 4 X 8 CHAP WHITE (Mercruiser Engines)	.13	SF
23n	123-0120	1/2 FLAME RET.SPLIT COND. (Mercruiser Engines)	38	FT
23o	LABEL-HOUSE	HOUSE BATTERY CABLE LABEL (Mercruiser Engines)	2	EA
23p	360-0380	3/8 IN. FUEL LINE TYPE A1 (Mercruiser Engines)	5.58	FT
23q	360-0380	3/8 IN. FUEL LINE TYPE A1 (Mercruiser Engines)	6.08	FT
23r	6708-5	#8 HOSE CLAMP (7/16-1) (Mercruiser Engines)	2	EA
23s	1943-1B	BLK CAP LG. .045 X .465 (Mercruiser Engines)	2	EA
23t	NC15	15/16IN. INSULATED CLAMP (Mercruiser Engines)	2	EA
23u	22-72932A3	MERC HEAT EXCHANGE KIT (Mercruiser Engines)	1	EA
23v	132-0580R	5/8 HD WATER HEATER HOSE (Mercruiser Engines)	7.67	FT
23w	132-0580R	5/8 HD WATER HEATER HOSE (Mercruiser Engines)	8.25	FT
23x	22-860099	COUPLING FOR DUAL ENGINES (Mercruiser Engines)	1	EA
24	3856903	TOP MOUNT TWIN W/TRIM (Volvo Engines)	1	EA
24a	3855708	POWER TRIM HARNESS 7M (Volvo Engines)	2	EA
24b	CC63320	20FT VOLVO EXTREME CABLE (Volvo Engines)	2	EA
24c	CC63321	21FT VOLVO EXTREME CABLE (Volvo Engines)	1	EA
24d	CC63322	22FT VOLVO EXTREME CABLE (Volvo Engines)	1	EA
24e	1163871	SPEEDO KIT W/O HOSE (Volvo Engines)	1	EA
24f	151-0400	4MM PITOT TUBING (Volvo Engines)	28	FT
24g	5324K81	SPRING HOSE CLAMP 1/4 IN. (Volvo Engines)	1	EA
24h	TI-T3-DO-250	1/4 INCH CLAMP (Volvo Engines)	3	EA
24i	1943-1B	BLK CAP LG. .045 X .465 (Volvo Engines)	66	EA
24j	6708-5	#8 HOSE CLAMP (7/16-1) (Volvo Engines)	2	EA
24k	NC15	15/16IN. INSULATED CLAMP (Volvo Engines)	5	EA
24l	46974	1/4 ST ELL 90 DEG 28-157S (Volvo Engines)	2	EA
24m	DBN32	1/4X3/8 BRASS BARB HOSE (Volvo Engines)	2	EA
24n	3850885	TIE BAR SX VOLVO (Volvo Engines)	1	EA
24o	2340-840	MIDGET VENT 1 1/2 X 1 3/4 (Volvo Engines)	1	EA
24p	LABEL-HOUSE	HOUSE BATTERY CABLE LABEL (Volvo Engines)	2	EA
24q	3862101	HEAT EXCHANGE KIT (Volvo Engines)	1	EA
24r	360-0380	3/8 IN. FUEL LINE TYPE A1 (Volvo Engines)	7.80	FT
24s	360-0380	3/8 IN. FUEL LINE TYPE A1 (Volvo Engines)	7.50	FT
24t	88334A2	MERCATHODE (Volvo Engines)	2	EA
24u	132-0580R	5/8 HD WATER HEATER HOSE (Volvo Engines)	8.33	FT
24v	132-0580R	5/8 HD WATER HEATER HOSE (Volvo Engines)	7.50	FT

NOTE: Numbers with letter designations represent parts included with primary numbered part for which there is no photo representation.

PARTS IDENTIFICATION GUIDE

SIGNATURE 270

2004 MODEL YEAR

Cockpit

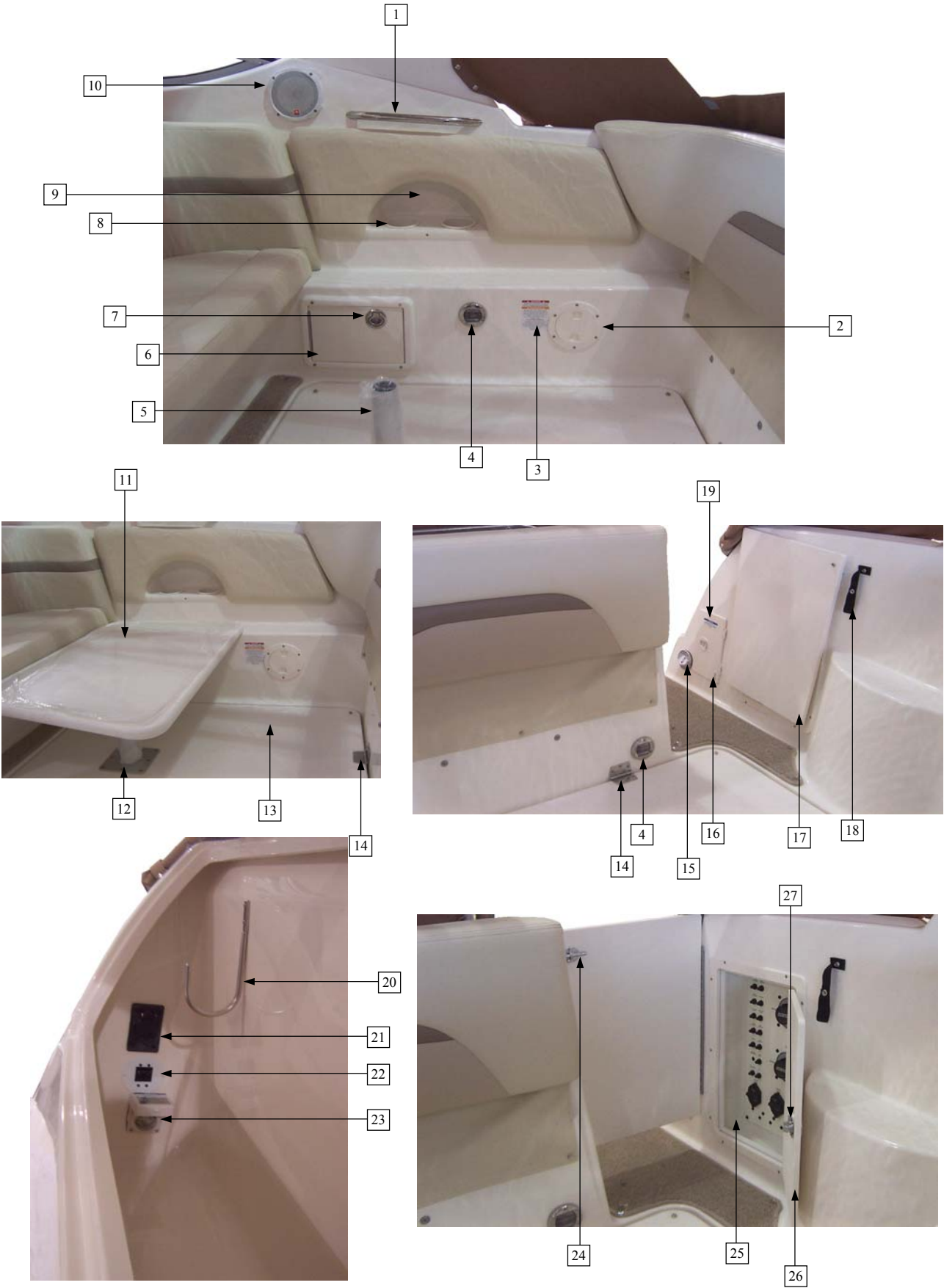

PARTS IDENTIFICATION GUIDE

SIGNATURE 270

2004 MODEL YEAR

Cockpit

Item No.	Part Number	Description	Qty.	U.O.M.
1	H-045	17 IN. OVAL GRABRAIL(50)	1	EA
2	DP40-38	4 INCH WHITE DECK PLATE	1	EA
3	U17218-01	IN CASE OF FIRE, SECURE ENGINE LABEL	1	EA
4	6356P1	TRANSOM LIGHT W/PACK.PLUG	1	EA
5	75359-84	11 1/2 LEGS	1	EA
5a	75359-83	27 1/2 LEGS	2	EA
6	3-0201	MACERATOR BOX (Option: Macerator)	1	EA
6a	IST12142	MANUAL BILGE BOX LID (Option: Macerator)	1	EA
6b	CB10605-04SS	1.06 X 5.5 .04SS C'SUNK HINGE (Option: Macerator)	1	EA
6c	230-01665-K	SPLIT MACERATOR PNL KIT (Option: Macerator)	1	KIT
6d	U18791-01	NOTICE- MACERATOR LABEL (Option: Macerator)	1	EA
6e	U18790-01	OPEN/CLOSE LABEL (Option: Macerator)	1	EA
6f	954DP2	DIAPHRAM PUMP W/SS HAND (Option: CE Pkg)	1	EA
6g	141-1120	1 1/2 IN MULTIFLEX-BLACK (Option: CE Pkg)	11.50	FT
6h	141-1120	1 1/2 IN MULTIFLEX-BLACK (Option: CE Pkg)	5	FT
7	M1-63-8	LATCH/FLUSH SS(5000 MIN) (Option: Macerator)	1	EA
8	LCH-1WS	LARGE CUPHOLDER-WHT SAND	2	EA
9	54400720	S300 TUB CUPHOLDER	1	EA
10	MS-610BW	JBL SPEAKERS	2	EA
11	4-1079	COCKPIT TABLE	1	EA
11a	02148RB9629-100	TABLE MOULDING WHITE (Part of Table Asy)	10.25	FT
12	75375-40	FLOOR BASE	1	EA
12a	3381-2403	HOLE PLUG	1	EA
13	3-1179	S270 ENGINE LID	1	EA
13a	16-323-00000	STAINLESS STEEL HANDLE	1	EA
14	1654	HINGE 3 IN. X 3IN.	2	EA
14a	SL62P3-1	FLAT BRACKET 10MM BALL	2	EA
15	540-WOO-CHR	WATER FILL/VENT FITTING	1	EA
15a	U13809-01	SYMBOL WATER CE LABEL (Option: CE Pkg)	1	EA
16	303SB7481	BONE TRANSOM SHOWER	1	EA
17	IST34306	S270 TRANSOM DOOR	1	EA
17a	IST34135	S300 TRANSOM DOOR STOP	1	EA
17b	U13767-01	WARNING OPEN DOORS MAY	1	EA
17c	CB12517-06SS	1.25 X 17 .06SS #SSCW 4" (Transom Door Hinge)	1	EA
18	INT-STR12S	12INCH STRAP W/SNAP	1	EA
19	U13777-01	NOTICE USING SHOWER LABEL	1	EA
20	R-1241	3/8 SS CABLE HOLDER (100)	1	EA
21	TV97	INLET	1	EA
22	220-03650-P	AC SHORE INLET PANEL	1	EA
23	HBL303NM	INLET PLUG (LOT 3)	1	EA
23a	U13779-01	NOTICE MAIN SHORE POWER	1	EA
23b	U13810-01	SYMBOL ELECTRICAL HAZARD (Option: CE Pkg)	1	EA
24	947-2	BARREL BOLT(25)	1	EA
24a	R-1227	STRIKER PLATE (200)	1	EA
25	205-00169-A	S270 DE BATTERY PANEL (Part of Panel Kit)	1	EA
26	100501	21 X 14 ACCESS DOOR	1	EA
27	M1-63-8	LATCH/FLUSH SS(5000 MIN)	1	EA

Parts Not Pictured Which Are Associated With Cockpit:

Not Pictured	JBLREM25W	WHITE REMOTE	1	EA
Not Pictured	100W1X1/4	WHITE TEXTURE TRIM (Aft Cockpit Seating)	8	FT
Not Pictured	0084IRI9629-014	7/8 X 7/8 WHT L MOULDING (Aft Cockpit Seating)	6	FT
Not Pictured	HBL61CM08W	50FT. CABLE 125V (LOT 3) (Shore Power)	1	EA
Not Pictured	HBL316CSW	50 FT WHITE CABLE 230V (Option: CE Pkg)	1	EA
Not Pictured	TV99	CORD (Shore Power)	1	EA
Not Pictured	35256	GALLEY RAIL (Port Seat Rail)	1	EA

NOTE: Numbers with letter designations represent parts included with primary numbered part for which there is no photo representation.

PARTS IDENTIFICATION GUIDE

SIGNATURE 270

2004 MODEL YEAR

Cockpit & Cockpit Galley



PARTS IDENTIFICATION GUIDE

SIGNATURE 270

2004 MODEL YEAR

Cockpit & Cockpit Galley

Item No.	Part Number	Description	Qty.	U.O.M.
1	34-00001	FAUCET-FOLDDOWN 3.5" SPOUT 1/2" NPS THRED	1	EA
2	35293	S270 WET BAR GRAB RAIL	1	EA
3	49500920	IGLOO RETAINER W/2 BACKER	1	EA
4	16776	25QT MARINE COOLER	1	EA
5	220-00331-A	WHITE GFCI ASSEMBLY (Part of AC Kit)	1	EA
5a	700-4998W	WHITE WEATHER PROOF COVER (Part of AC Kit)	1	EA
6	MS-610BW	JBL SPEAKERS	2	EA

NOTE: Numbers with letter designations represent parts included with primary numbered part for which there is no photo representation.

PARTS IDENTIFICATION GUIDE

SIGNATURE 270

2004 MODEL YEAR

Deck-Underside



PARTS IDENTIFICATION GUIDE

SIGNATURE 270

2004 MODEL YEAR

Deck-Underside

Item No.	Part Number	Description	Qty.	U.O.M.
1	CB-4	BLK MTR WELL BOOT 4 1/2	2	EA
2	APD-290	90 DEG. WHITE DRAIN (Forward Liner Drain)	1	EA
3	141-0340	3/4 IN. MULTIFLEX (Forward Liner Drain)	6	FT
4	402-4000	4 INCH BLACK VINYL VENT	3.50	FT
5	SL62P3-1	FLAT BRACKET 10MM BALL	4	EA
6	SL28-30-1	30 LB GAS SHOCK 24PER BOX 10IN X 22	2	EA
7	3-1179	S270 ENGINE LID	1	EA
7a	16-323-00000	STAINLESS STEEL HANDLE	1	EA
7b	1654	HINGE 3 IN. X 3IN.	2	EA
8	328-008	1 1/2IN PLASTIC THRU HULL (Aft Liner Drains)	3	EA
9	350-1120L	1 1/2IN FUEL FILL HOSE	10	FT
10	402-4000	4 INCH BLACK VINYL VENT	3.50	FT
11	141-1120	1 1/2 IN MULTIFLEX-BLACK (Water Fill Vent to Water Tank)	5	FT
12	210-00518-F	OIL DISCHARGE FACEPLATE (Part of Panel Kit)	1	EA
13	75375-40	FLOOR BASE	1	EA
13a	3381-2403	SOLE PLUG	1	EA
14	141-0340	3/4 IN. MULTIFLEX (Cockpit Galley Sink Drain)	6	FT
14a	APD-290F	90 DEG. WHITE FLAT DRAIN (Cockpit Galley Sink Drain)	1	EA
14b	PP-118	PUSH PLUG - VINYL	2	EA

Parts Not Pictured Which Are Associated With Deck Underside:

Not Pictured	350	BUSHING SKI STORAGE (Dunnage Box)	2	EA
Not Pictured	PC2	2 INCH PVC CAP	1	EA
Not Pictured	597	1 1/8-1 1/4 THRU HULL 90@ (Anchor Locker Drain)	1	EA
Not Pictured	141-1180	1 1/8 IN. MULTIFLEX (Anchor Locker Drain)	2	FT
Not Pictured	328-008	1 1/2IN PLASTIC THRU HULL	1	EA

NOTE: Numbers with letter designations represent parts included with primary numbered part for which there is no photo representation.

PARTS IDENTIFICATION GUIDE

SIGNATURE 270

2004 MODEL YEAR

Engine Well

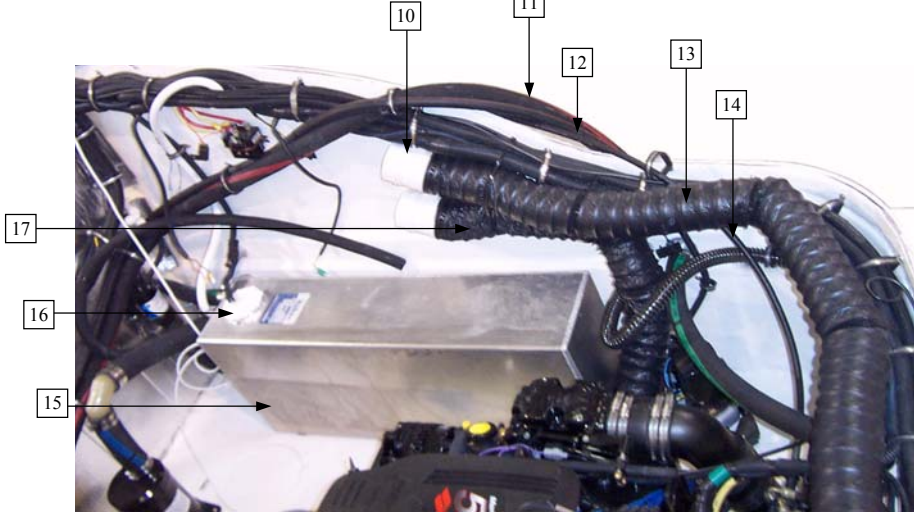
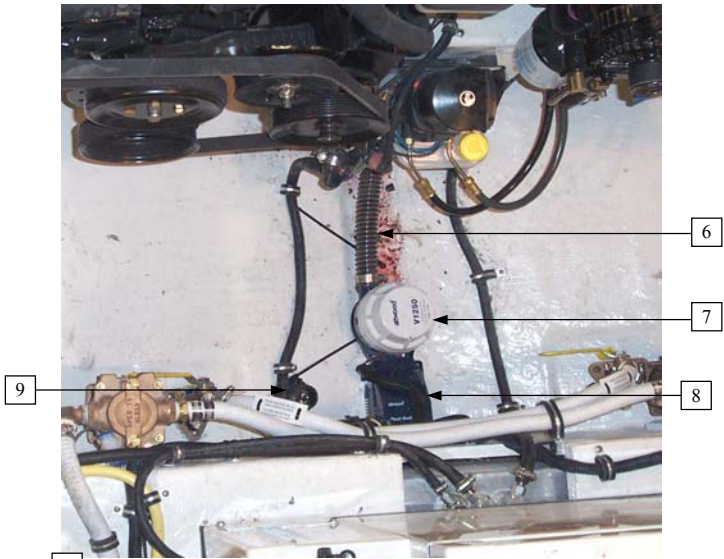
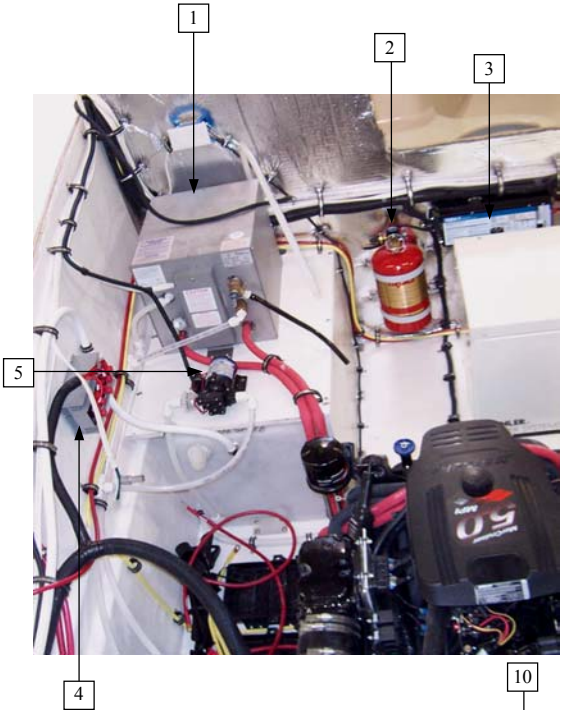

PARTS IDENTIFICATION GUIDE

SIGNATURE 270

2004 MODEL YEAR

Engine Well

Item No.	Part Number	Description	Qty.	U.O.M.
1	F600	6GAL 110V HOTWATER HEATER	1	EA
1a	F650	6GL 220V HOT WATER HEATER (Option: Int'l & CE Pkg)	1	EA
2	CG2-250-FE241	FIRE EXTINGUISHER (Option: Fire Extinguisher)	1	EA
2a	CG2-150-227	FIRE EXTINGUISHER (Option: Int'l Fire System & CE Pkg)	1	EA
3	61240	12 VOLT - 40 AMP CHARGER	1	EA
4	93-BI702/3C-A	70AMP 2ALT 3BANK ISOLATOR	1	EA
5	2095-223-644	SHURFLO PUMP CE W/PLUG	1	EA
5a	170-061-00	FILTER 1/2 IN. PIPE THRED	1	EA
6	141-1180	1 1/8 IN. MULTIFLEX (Aft Bilge to Thru Hull)	11	FT
7	4212P1	V1250 BILGE PUMP (Aft Bilge)	1	EA
8	4201P1	AUTO FLOAT SWITCH W/COVER (Aft Bilge)	1	EA
9	SN1020	THRU HULL TRANSDUCER	1	EA
9a	HN0337	17' TRANSDUCER HRNS	1	EA
10	1743P1	4" BLOWER W/ PACKARD PLUG	2	EA
11	350-1120L	1 1/2IN FUEL FILL HOSE	10	FT
12	360-0580	5/8 FUEL LINE TYPE A1	10	FT
13	402-4000	4 INCH BLACK VINYL VENT (Engine Ventilation)	12	FT
14	SSC6216	16 FT. STEERING CABLE	1	EA
15	30134	25 GAL HOLDING TANK (2003)	1	EA
15a	B507601	25G HOLDING TANK/ PLASTIC (2004)	1	EA
15b	EL112	11/2 MPT 11/2HBB NYLCPL90	1	EA
15c	A112	1 1/2MPT 1 1/2HBB NYL CPL	2	EA
15d	EL3458	3/4 MPT 5/8HBB NYL CPL 90	2	EA
16	3132230277	TANK WATCH 2 LEVEL IND	1	EA
16a	48033	3/8 ALUMINUM PLUG	1	EA
17	402-4000	4 INCH BLACK VINYL VENT (Engine Ventilation)	5.50	FT
17a	402-4000	4 INCH BLACK VINYL VENT (Engine Ventilation)	3.50	FT
17b	402-4000	4 INCH BLACK VINYL VENT (Engine Ventilation)	3.50	FT
18	500291	1/2 FOIL FACE FOAM(25 YD)	3.20	LYD

Parts Not Pictured Which Are Associated With Engine Well:

Not Pictured	31604	100G AL FUEL TANK W/FILTE S270 W/PA	1	EA
Not Pictured	118-CHAP1X10	1/4 X 1 INCH RUBBER	18.60	FT
Not Pictured	CHRG40MM	40 FT COAX MALE X MALE	1	EA
Not Pictured	M-1-NF-C	GAS VAPOR DETECTOR (Option: Gas Vapor Detector)	1	EA
Not Pictured	4720K15	FUEL TROL(Option:Fuel Shut Off Twin Engine)	2	EA
Not Pictured	DBN32	1/4X3/8 BRASS BARB HOSE (Option: Fuel Shut Off Twin Engine)	4	EA
Not Pictured	230-00796-K	99-DUAL FUEL SHUTOFF KIT	1	EA
Not Pictured	U17408-01	LEAKING FUEL DECAL	1	EA
Not Pictured	4-1000	FIRE EXTINGUISHER BRACKET	1	EA
Not Pictured	U19848-01	DANGER LABEL-RESEAL	1	EA

NOTE: Numbers with letter designations represent parts included with primary numbered part for which there is no photo representation.

PARTS IDENTIFICATION GUIDE

SIGNATURE 270

2004 MODEL YEAR

Engine Well

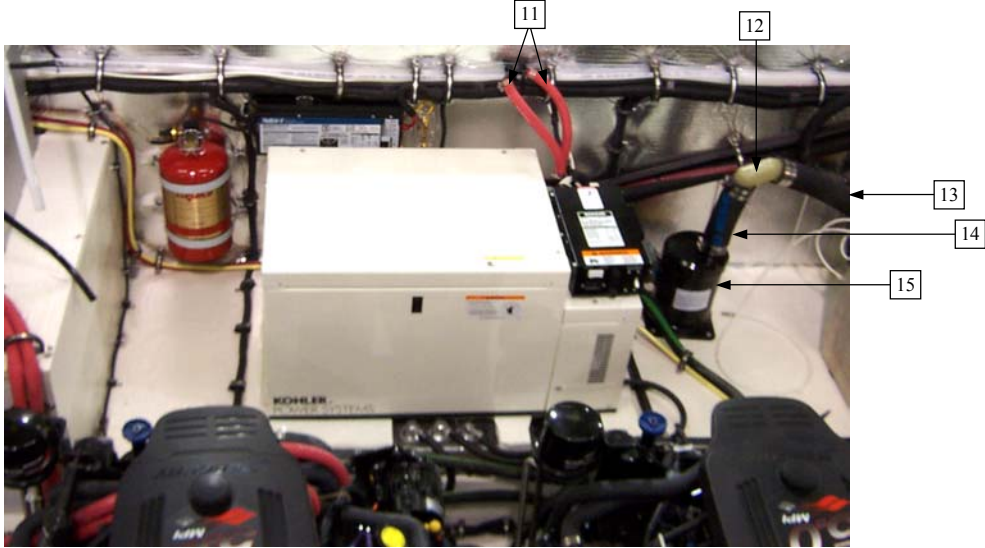
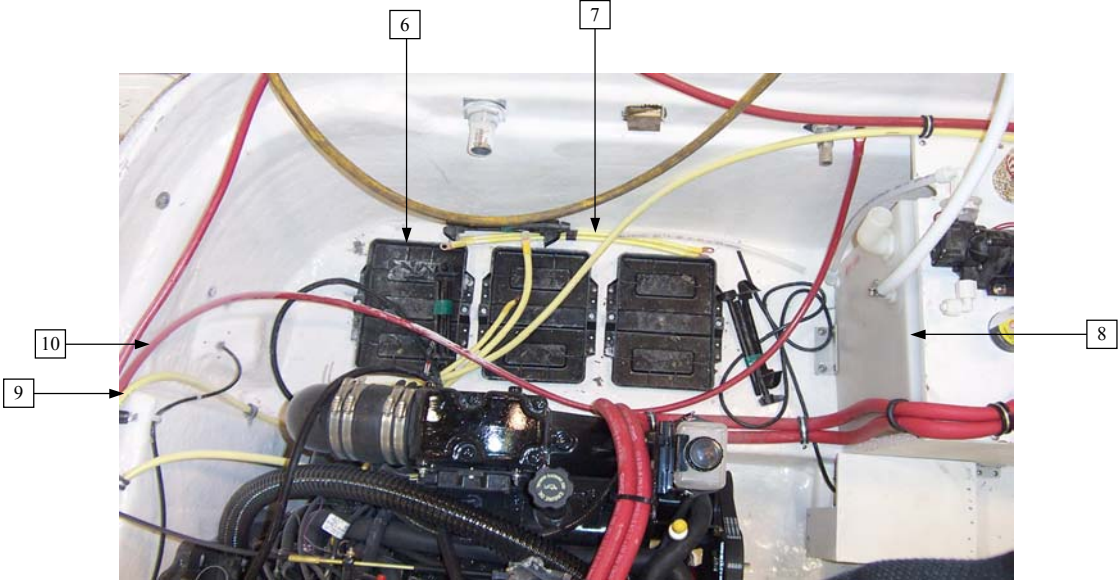

PARTS IDENTIFICATION GUIDE

SIGNATURE 270

2004 MODEL YEAR

Engine Well

Item No.	Part Number	Description	Qty.	U.O.M.
1	20-168-ROO	168IN 2/0 POSITIVE BATT. (Engine to Switch)	1	EA
1a	20-144-ROO	144IN 2/0 POSITIVE BATT. (Engine to Switch)	1	EA
2	GEN-216-R2	216" 2GA GEN. CABLE (Option: Generator)	1	EA
2a	LABEL-GENERATOR	GEN. BATTERY CABLE LABEL (Option: Generator)	2	EA
3	GEN-192-Y2	192" 2GA YELLOW CABLE (Option: Generator)	1	EA
3a	GEN-108-Y2	108" 2GA. YELLOW CABLE (Option: Generator)	1	EA
4	5ECBSSS	S300 GENERATOR 60 HZ. (Option: Generator)	1	EA
4a	118-CHAP1X10	1/4 X 1 INCH RUBBER (Option: Generator)	.50	FT
4b	221-03907-P	S270/310/350 GEN. PANEL (Option: Generator)	1	EA
5	20-096-YO	96IN 1/0 GROUND BAT.CABLE (Battery to Engine)	1	EA
5a	20-084-YO	84IN 1/0 GROUND BAT.CABLE (Battery to Engine)	1	EA
5b	20-048-Y2	48IN GROUND BATTERY CABLE (Battery to Engine)	1	EA
6	9091-1	BATTERY TRAY 27 SERIES BATTERY	3	EA
6a	458N0V02	DUAL BATT. BOOT RED	3	EA
6b	458N0V14	DUAL BATT. BOOT BLACK	3	EA
6c	600N7V02	DUAL POST BATT. COVER RED	3	EA
6d	600N7V14	DUAL POST BATTERY BLACK	3	EA
7	20-018-Y2	18IN GROUND BATTERY CABLE (Battery to Battery)	2	EA
8	97-1539	S300 WATER TANK	1	EA
8a	118-CHAP1X10	1/4 X 1 INCH RUBBER	6	FT
8b	4-0146	1.5X1.5X1/8 4IN. BRACKET (Connects Water Tank to Bulkhead)	1	EA
8c	4-0124	ANGLE BRACKET 1X1X1/8-2IN (Connects Water Tank Boards)	5	EA
8d	4-1013	4IN FUEL TK BRACKET (Connects Water Tank to Floor)	3	EA
9	20-024-Y2	24IN GROUND BATTERY CABLE (Engine to Engine)	1	EA
10	20-036-R2	36IN POSITIVE BATT.CABLE (Battery to Switch)	3	EA
11	132-0580R	5/8 HD WATER HEATER HOSE (Option: Generator)	2	FT
11a	100-0340	3/4 HARDWALL WATER HOSE (Option: Generator)	2.67	FT
12	EL-020-0090	90 DEGREE EXHAUST EL W (Option: Generator)	1	EA
12a	DBN66	3/4MPT 3/4HBB BRS CPL (Option: Generator)	2	EA
13	200-2000	2IN SOFTWALL EXHAUST HOSE (Option: Generator)	1.75	FT
13a	200-2000	2IN SOFTWALL EXHAUST HOSE (Option: Generator)	.50	FT
14	200-2000	2IN SOFTWALL EXHAUST HOSE (Option: Generator)	1.54	FT
15	SA-200-0609	260/270/280 GEN. MUFFLER (Option: Generator)	1	EA

Parts Not Pictured Which Are Associated With Generator Option:

Not Pictured	100-0340	3/4 HARDWALL WATER HOSE (Option: Generator)	1.75	FT
Not Pictured	65-007-51	3/4 PIPE HOSE ADAPTER (Option: Generator)	1	EA
Not Pictured	78-115-01	3/4 BRONZE SEA FLANGE (Option: Generator)	1	EA
Not Pictured	L567205	3/4 BRONZE THRU HULL (Option: Generator)	1	EA
Not Pictured	U13814-01	RAW WATER INLET/GENERATOR (Option: Generator)	1	EA
Not Pictured	493-5	3/4 WATER STRAINER(5) (Option: Generator)	1	EA
Not Pictured	6712-5	#12 HOSE CLAMP(1/2-1 1/4) (Option: Generator)	6	EA
Not Pictured	1943-1B	BLK CAP LG. .045 X .465 (Option: Generator)	14	EA
Not Pictured	6732-5	#32 HOSE CLAMP (Option: Generator)	32	EA
Not Pictured	71008	2IN. SS THRU HULL (Option: Generator)	1	EA
Not Pictured	NC15	15/16IN. INSULATED CLAMP (Option: Generator)	6	EA
Not Pictured	6708-5	#8 HOSE CLAMP (7/16-1) (Option: Generator)	4	EA
Not Pictured	1943-2B	BLK CAP SM. .034 X .300 (Option: Generator)	4	EA
Not Pictured	100W1X1/4	WHITE TEXTURE TRIM (Option: Generator)	.25	FT
Not Pictured	1/4AL.ASV	1/4 ALM ANTI SIPHON VALVE (Option: Generator)	1	EA
Not Pictured	360-0140	1/4IN TYPE A FUEL HOSE (Option: Generator)	2.50	FT
Not Pictured	9067-1	BATTERY BOX POWER GUARD 27 BLACK (CE Pkg.)	3	EA

NOTE: Numbers with letter designations represent parts included with primary numbered part for which there is no photo representation.

PARTS IDENTIFICATION GUIDE

SIGNATURE 270

2004 MODEL YEAR

Engine Well

Item No.	Part Number	Description	Qty.	U.O.M.
Not Pictured	4EFCBSS	GAS GENERATOR W/SOUND SHIELD&SIPHON	1	EA
	LABEL-GENERATOR	GEN. BATTERY CABLE LABEL (Option: 220V Generator)	2	EA
	65-007-51	3/4 PIPE HOSE ADAPTER (Option: 220V Generator)	1	EA
	78-115-01	3/4 BRONZE SEA FLANGE (Option: 220V Generator)	1	EA
	L567205	3/4 BRONZE THRU HULL (Option: 220V Generator)	1	EA
	U13814-01	RAW WATER INLET/GENERATOR (Option: 220V Generator)	1	EA
	DBN66	3/4MPT 3/4HBB BRS CPL (Option: 220V Generator)	2	EA
	100-0340	3/4 HARDWALL WATER HOSE (Option: 220V Generator)	1.75	FT
	NC15	15/16IN. INSULATED CLAMP (Option: 220V Generator)	1	EA
	6712-5	#12 HOSE CLAMP(1/2-1 1/4) (Option: 220V Generator)	4	EA
	1943-1B	BLK CAP LG. .045 X .465 (Option: 220V Generator)	4	EA
	493-5	3/4 WATER STRAINER(5) (Option: 220V Generator)	1	EA
	NC15	15/16IN. INSULATED CLAMP (Option: 220V Generator)	3	EA
	6712-5	#12 HOSE CLAMP(1/2-1 1/4) (Option: 220V Generator)	2	EA
	1943-1B	BLK CAP LG. .045 X .465 (Option: 220V Generator)	2	EA
	6732-5	#32 HOSE CLAMP (Option: 220V Generator)	32	EA
	1943-1B	BLK CAP LG. .045 X .465 (Option: 220V Generator)	8	EA
	SA-200-0609	260/270/280 GEN. MUFFLER (Option: 220V Generator)	1	EA
	EL-020-0090	90 DEGREE EXHAUST EL W (Option: 220V Generator)	1	EA
	71008	2IN. SS THRU HULL (Option: 220V Generator)	1	EA
	NC15	15/16IN. INSULATED CLAMP (Option: 220V Generator)	2	EA
	6708-5	#8 HOSE CLAMP (7/16-1) (Option: 220V Generator)	2	EA
	1943-2B	BLK CAP SM. .034 X .300 (Option: 220V Generator)	2	EA
	GEN-192-Y2	192" 2GA YELLOW CABLE (Option: 220V Generator)	1	EA
	20-180-ROO	180IN 2/0 POSITIVE BATT. (Option: 220V Generator)	1	EA
	GEN-108-Y2	108" 2GA. YELLOW CABLE (Option: 220V Generator)	1	EA
	6708-5	#8 HOSE CLAMP (7/16-1) (Option: 220V Generator)	2	EA
	1943-2B	BLK CAP SM. .034 X .300 (Option: 220V Generator)	2	EA
	1/4AL.ASV	1/4B X 1/4MPT ANTI SIPHON (Option: 220V Generator)	1	EA
	100-0340	3/4 HARDWALL WATER HOSE (Option: 220V Generator)	2.67	FT
	100W1X1/4	WHITE TEXTURE TRIM 5000FT PRICE (Option: 220V Generator)	.25	FT
	118-CHAP1X10	1/4 X 1 INCH RUBBER (Option: 220V Generator)	.50	FT
	132-0580R	5/8 HD WATER HEATER HOSE (Option: 220V Generator)	2	FT
	200-2000	2IN SOFTWALL EXHAUST HOSE (Option: 220V Generator)	1.75	FT
	200-2000	2IN SOFTWALL EXHAUST HOSE (Option: 220V Generator)	.50	FT
	200-2000	2IN SOFTWALL EXHAUST HOSE (Option: 220V Generator)	1.54	FT
	360-0140	1/4IN TYPE A FUEL HOSE (Option: 220V Generator)	2.50	FT
	221-03907-P	S270/310/350 GEN. PANEL (Option: 220V Generator)	1	EA
	GEN-216-R2	216" 2GA GEN. CABLE (Option: 220V Generator)	1	EA

PARTS IDENTIFICATION GUIDE

SIGNATURE 270

2004 MODEL YEAR

Fresh Water

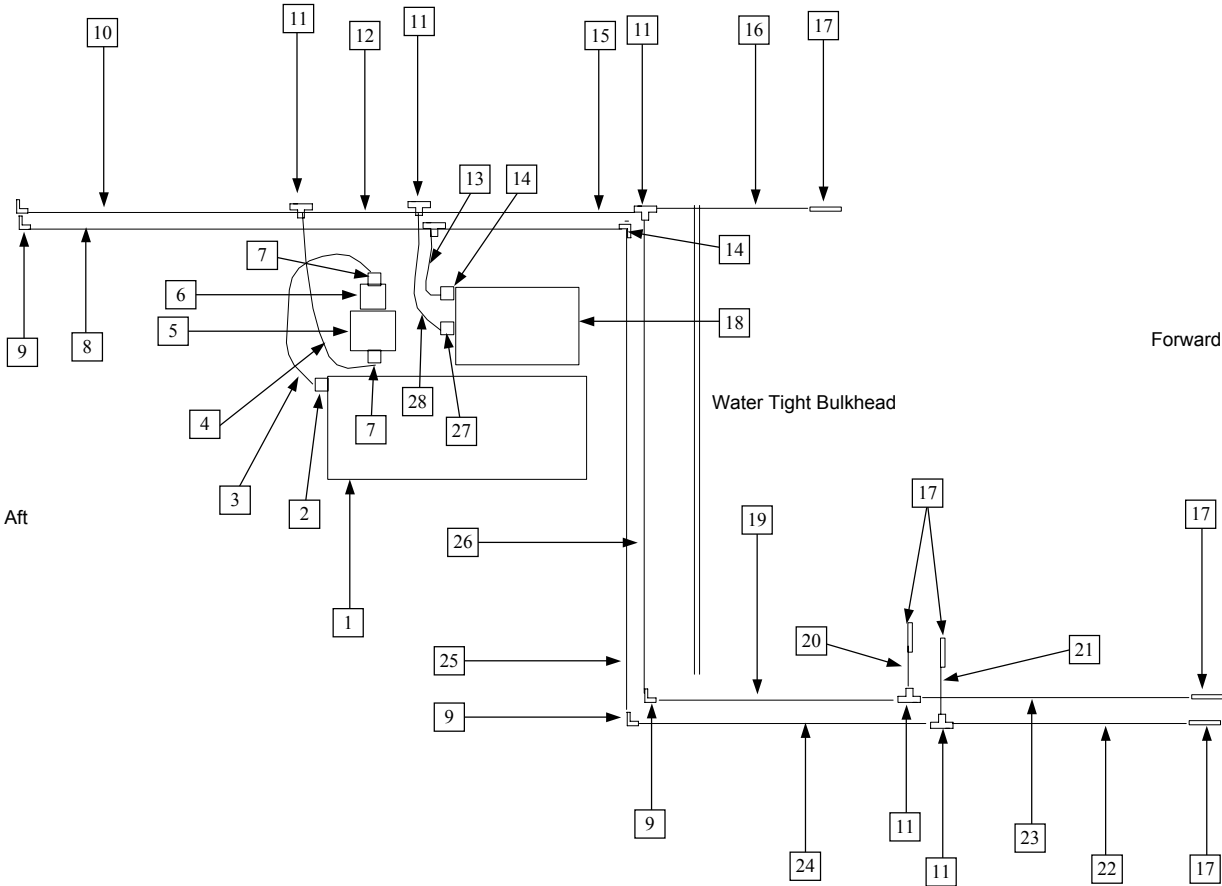

PARTS IDENTIFICATION GUIDE

SIGNATURE 270

2004 MODEL YEAR

Fresh Water

Item No.	Part Number	Description	Qty.	U.O.M.
1	97-1539	S300 WATER TANK	1	EA
1a	148-0580	5/8 WHITE SMOOTH PVC HOSE (Water Tank to Vent)	3.17	FT
1b	141-1120	1 1/2 IN MULTIFLEX-BLACK (Water Tank to Water Fill Vent Fitting)	5	FT
2	F06812	1/2P X 3/4 MPT MALE ELBOW	1	EA
3	C1/2X100PEX	1/2 IN. PEX COLD COIL	1.50	FT
4	C1/2X100PEX	1/2 IN. PEX COLD COIL	1.54	FT
5	2095-223-644	SHURFLO PUMP CE W/PLUG	1	EA
6	170-061-00	FILTER 1/2 IN. PIPE THRED	1	EA
7	F06800	1/2P X 1/2P 90 DEG. ELBOW	1	EA
8	H1/2X100PEX	1/2 IN. PEX HOT COIL	5	FT
9	F06816	1/2X1/2 FPT SWIVEL ELBOW	4	EA
10	C1/2X100PEX	1/2 IN. PEX COLD COIL	3	FT
11	F06820	1/2P X 1/2P X 1/2P TEE	6	EA
12	C1/2X100PEX	1/2 IN. PEX COLD COIL	1.25	FT
13	H1/2X100PEX	1/2 IN. PEX HOT COIL	.54	FT
14	F06803	1/2 P X 1/2 MPT ELBOW	2	EA
15	C1/2X100PEX	1/2 IN. PEX COLD COIL	2.75	FT
16	C1/2X100PEX	1/2 IN. PEX COLD COIL	3.48	FT
17	F06873	1/2P X 1/2FPT STR SWVL BS	5	EA
18	F600	6GAL 110V HOTWATER HEATER	1	EA
19	C1/2X100PEX	1/2 IN. PEX COLD COIL	7	FT
20	C1/2X100PEX	1/2 IN. PEX COLD COIL	.40	FT
21	H1/2X100PEX	1/2 IN. PEX HOT COIL	.40	FT
22	H1/2X100PEX	1/2 IN. PEX HOT COIL	4.50	FT
23	C1/2X100PEX	1/2 IN. PEX COLD COIL	4.50	FT
24	H1/2X100PEX	1/2 IN. PEX HOT COIL	7	FT
25	H1/2X100PEX	1/2 IN. PEX HOT COIL	10.21	FT
26	C1/2X100PEX	1/2 IN. PEX COLD COIL	7.29	FT
27	P8N12C	1/2XCLOSE S80 PVC NIPPLE	1	EA
27a	3/8RC	ROMEX CONNECTOR	1	EA
27b	CV50BS	1/2 BRASS CHECK VALVE	1	EA
28	C1/2X100PEX	1/2 IN. PEX COLD COIL	1.15	FT

NOTE: Numbers with letter designations represent parts included with primary numbered part for which there is no photo representation.

PARTS IDENTIFICATION GUIDE

SIGNATURE 270

2004 MODEL YEAR

Waste System

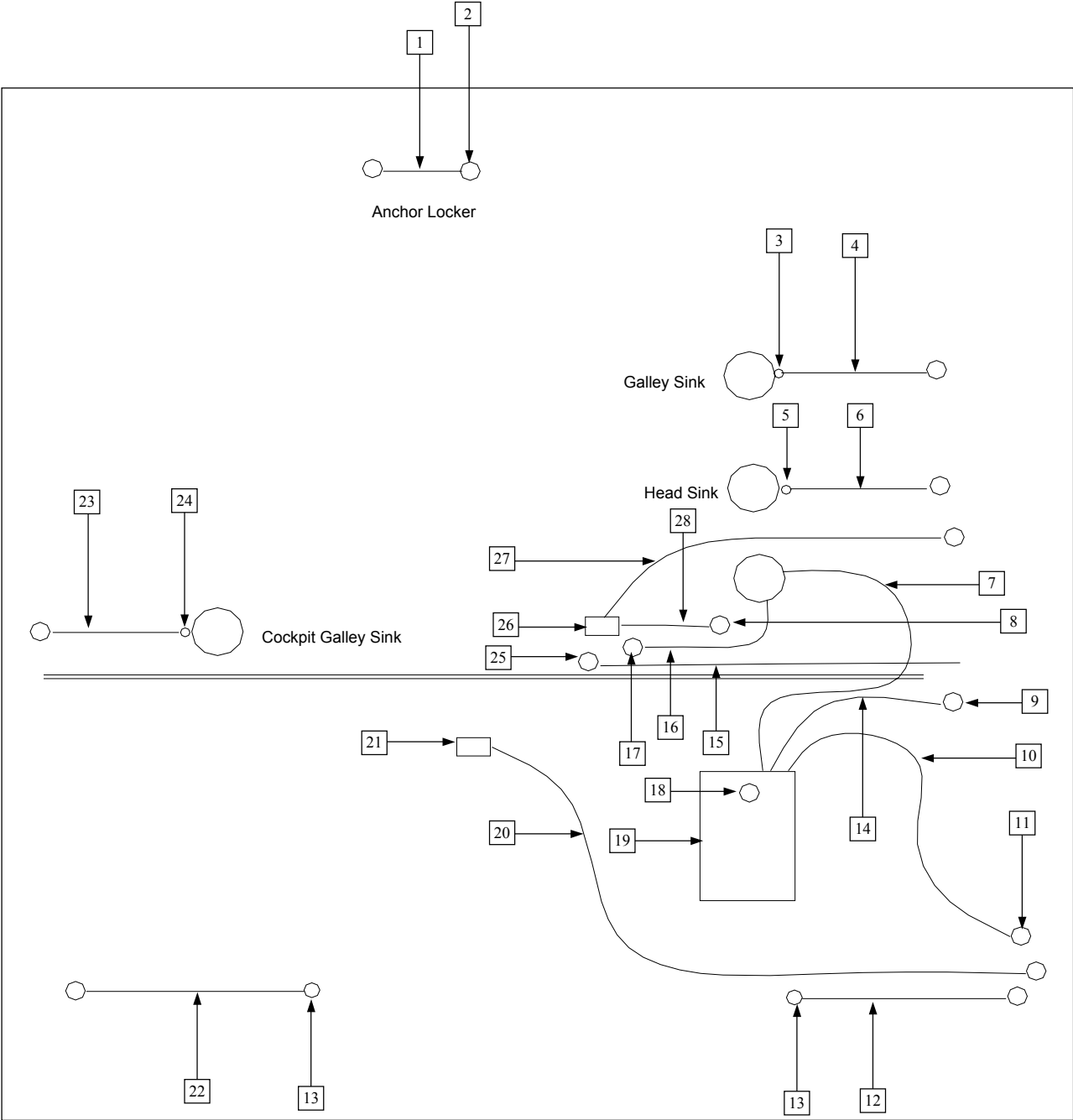

PARTS IDENTIFICATION GUIDE

SIGNATURE 270

2004 MODEL YEAR

Waste System

Item No.	Part Number	Description	Qty.	U.O.M.
1	141-1180	1 1/8 IN. MULTIFLEX (Anchor Locker Drain)	2	FT
2	597	1 1/8-1 1/4 THRU HULL 90@ (Anchor Locker Drain)	1	EA
3	655010XFBB	BLK 8 WASTE ARM HL W/FIB (Galley Sink Drain)	1	EA
3a	10313	DRAIN W/BASKET STRAINER (Galley Sink Drain)	1	EA
4	141-1120	1 1/2 IN MULTIFLEX-BLACK (Galley Sink Drain)	3.50	FT
5	65SPR1303	1-1/4 X 5 LAV. DRAIN (Head Sink Drain)	1	EA
6	141-1140	1 1/4 IN. MULTIFLEX (Head Sink Drain)	1.50	FT
7	104-1120	1 1/2 SANITATION HOSE (Toilet to Waste Tank)	7	FT
8	34B1057R	1-1/2 RUBBER FLAT GASKET (Shower Drain)	1	EA
8a	35B553	1 1/2 SLIP NUT-METAL (Shower Drain)	1	EA
8b	74RF839901	5/8 STRAINER 90 DEGREE (Shower Drain)	1	EA
8c	33RP-127-G	1 1/2 IN. SHOWER STRAINER (Shower Drain)	1	EA
9	954	FLUSH FUEL VENT	1	EA
10	104-1120	1 1/2 SANITATION HOSE (Waste Tank to Waste Access Fitting)	7	FT
11	556-SPL-003	WASTE FILL WITH RETAINER	1	EA
11a	U13759-01	SYMBOL DESIGNATOR WASTE (Option: CE Pkg)	1	EA
12	104-1120	1 1/2 SANITATION HOSE (Starboard Stern Drain)	2.50	FT
13	328-008	1 1/2IN PLASTIC THRU HULL (Stern Drains)	2	EA
14	148-0580	5/8 WHITE SMOOTH PVC HOSE (Waste Tank to Vent)	5	FT
15	141-0340	3/4 IN. MULTIFLEX (Forward Bilge to Thru Hull)	7	FT
16	100-0340	3/4 HARDWALL WATER HOSE (Water Pickup to Toilet)	6	FT
17	65-007-51	3/4 PIPE HOSE ADAPTER (Water Pickup)	1	EA
17a	78-115-01	3/4 BRONZE SEA FLANGE (Water Pickup)	1	EA
17b	L567205	3/4 BRONZE THRU HULL (Water Pickup)	1	EA
17c	U13813-01	RAW WATER/ MARINE HEAD (Water Pickup)	1	EA
18	3132230277	TANK WATCH 2 LEVEL IND W/PLUG	1	EA
19	B507601	25G HOLDING TANK/ PLASTIC	1	EA
20	141-1180	1 1/8 IN. MULTIFLEX (Aft Bilge Drain)	11	FT
21	4212P1	V1250 BILGE PUMP (Aft Bilge)	1	EA
21a	4201P1	AUTO FLOAT SWITCH W/COVER (Aft Bilge)	1	EA
22	104-1120	1 1/2 SANITATION HOSE (Port Stern Drain)	2.50	FT
23	141-0340	3/4 IN. MULTIFLEX (Cockpit Galley Sink Drain)	6	FT
24	APD-290F	90 DEG. WHITE FLAT DRAIN (Cockpit Galley Sink Drain)	1	EA
25	4204PC1	V500 BILGE PUMP W/PLUG (Forward Bilge)	1	EA
25a	4202P1	FLOAT SWITCH W/O COVER (Forward Bilge)	1	EA
26	4137P1	SHOWER SUMP W/ PACK. PLUG	1	EA
27	141-0340	3/4 IN. MULTIFLEX (Sump Box to Thru Hull)	7	FT
28	141-0340	3/4 IN. MULTIFLEX (Shower Drain to Sump Box)	1	FT

NOTE: Numbers with letter designations represent parts included with primary numbered part for which there is no photo representation.

PARTS IDENTIFICATION GUIDE

SIGNATURE 270

2004 MODEL YEAR

Waste Options

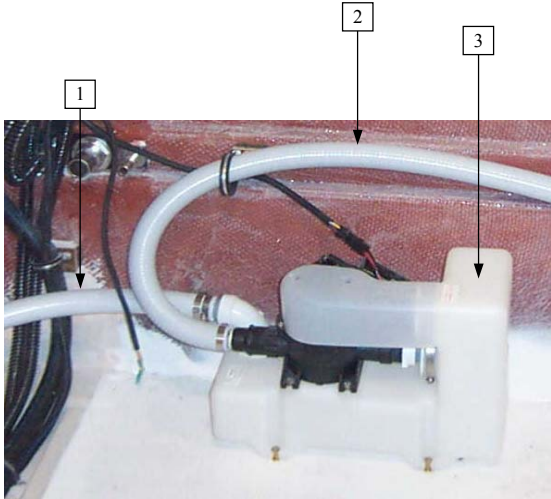

VACUUM GENERATOR



MACERATOR

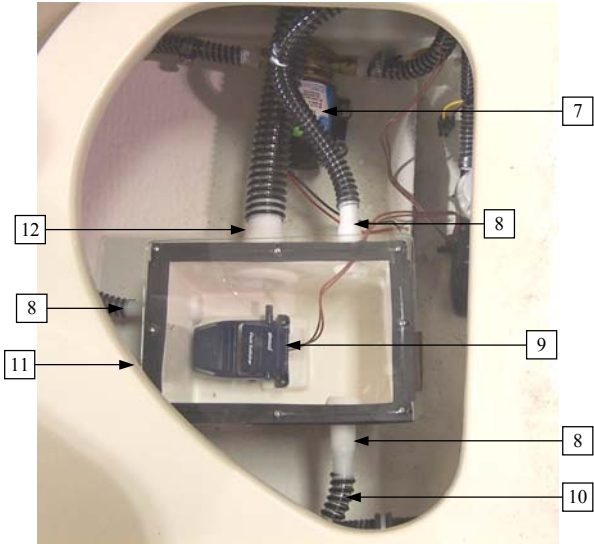

GRAY WATER

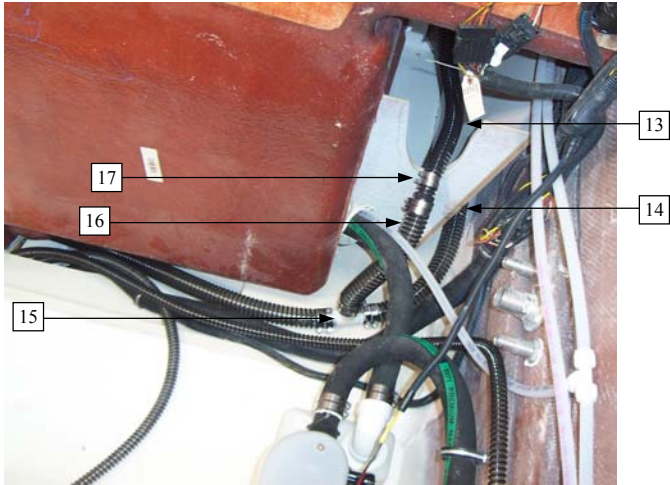

GRAY WATER

PARTS IDENTIFICATION GUIDE

SIGNATURE 270

2004 MODEL YEAR

Waste Options

Item No.	Part Number	Description	Qty.	U.O.M.
1	104-1120	1 1/2 SANITATION HOSE (Option: Vac Generator)	3	FT
2	104-1120	1 1/2 SANITATION HOSE (Option: Vac Generator)	6	FT
3	317759312	VACUUM GENERATOR W/PLUG (Option: Vac Generator)	1	EA
4	18590-7003	12Vdc RUN DRY MAC.W/CONNE (Option: Macerator)	1	EA
5	104-1120	1 1/2 SANITATION HOSE (Option: Macerator)	1.16	FT
5a	104-1120	1 1/2 SANITATION HOSE (Option: Macerator)	.33	FT
6	104-1000	1 SANITATION HOSE (Option: Macerator)	4.50	FT
7	18660-0121	SELF PRIMING PUMP (Option: Gray Water System)	1	EA
8	301-5	3/4 IN. PLASTIC THRU-HULL (Option: Gray Water System)	3	EA
9	4202P1	FLOAT SWITCH W/O COVER (Option: Gray Water System)	1	EA
10	141-0340	3/4 IN. MULTIFLEX (Option: Gray Water System)	22	FT
11	588-972953	SUMP PUMP LID (Option: Gray Water System)	1	EA
12	328-008	1 1/2IN PLASTIC THRU HULL (Option: Gray Water System)	1	EA
13	141-1140	1 1/4 IN. MULTIFLEX (Option: Gray Water System)	1.33	FT
13a	141-1140	1 1/4 IN. MULTIFLEX (Option: Gray Water System)	2.50	FT
14	141-1120	1 1/2 IN MULTIFLEX-BLACK (Option: Gray Water System)	12	FT
15	TEE-150	REDUCING T 1 1/2X3/4X1 1/2 (Option: Gray Water System)	1	EA
16	141-1120	1 1/2 IN MULTIFLEX-BLACK (Option: Gray Water System)	1	FT
17	8895	1 1/4 TO 1 1/2 HOSE ADAPT (Option: Gray Water System)	1	EA

Parts Not Pictured Which Are Associated With Waste Options:

Not Pictured	EL100P	1MPT X 1HOSE ELL NYL (Option: Macerator)	1	EA
Not Pictured	A100P	NYL 1MPT X 1HOSE (Option: Macerator)	1	EA
Not Pictured	T112P	1 1/2 NYLON TEE MENDER (Option: Macerator)	1	EA
Not Pictured	6724-5	#24 HOSE CLAMP (1-2) (Option: Macerator)	4	EA
Not Pictured	6712-5	#12 HOSE CLAMP(1/2-1 1/4) (Option: Macerator)	2	EA
Not Pictured	6716-5	#16 HOSE CLAMP(3/4-1 1/2) (Option: Macerator)	4	EA
Not Pictured	1943-1B	BLK CAP LG. .045 X .465 (Option: Macerator)	5	EA
Not Pictured	U18791-01	NOTICE- MACERATOR LABEL (Option: Macerator)	1	EA
Not Pictured	U18790-01	OPEN/CLOSE LABEL (Option: Macerator)	1	EA
Not Pictured	317074901	VACUFLUSH TOILET 749 WHT (Option: Vac Generator)	1	EA
Not Pictured	221-00329-A	VAC FLUSH SWITCH ASSY (Option: Vac Generator)	1	EA
Not Pictured	C1/2X100PEX	1/2 IN. PEX COLD COIL (Option: Vac Generator)	2.50	FT
Not Pictured	F06873	1/2P X 1/2FPT STR SWVL BS (Option: Vac Generator).	1	EA
Not Pictured	F06820	1/2P X 1/2P X 1/2P TEE (Option: Vac Generator)	1	EA
Not Pictured	6724-5	#24 HOSE CLAMP (1-2) (Option: Vac Generator)	3	EA
Not Pictured	1943-1B	BLK CAP LG. .045 X .465 (Option: Vac Generator)	2	EA
Not Pictured	141-0340	3/4 IN. MULTIFLEX (Option: Gray Water System)	10	FT
Not Pictured	141-0340	3/4 IN. MULTIFLEX (Option: Gray Water System)	2.50	FT
Not Pictured	141-0340	3/4 IN. MULTIFLEX (Option: Gray Water System)	1.50	FT
Not Pictured	141-0340	3/4 IN. MULTIFLEX (Option: Gray Water System)	1.50	FT
Not Pictured	141-0340	3/4 IN. MULTIFLEX (Option: Gray Water System)	1.50	FT
Not Pictured	A1234	1/2 MPT 3/4 HBB NYL CPL (Option: Gray Water System)	2	EA
Not Pictured	T112P	1 1/2 NYLON TEE MENDER (Option: Gray Water System)	1	EA
Not Pictured	NC28	1 3/4 IN. ALUM.CUSH.CLAMP (Option: Gray Water System)	6	EA
Not Pictured	NC16	1IN.ALUM. CUSHIONED CLAMP (Option: Gray Water System)	2	EA
Not Pictured	NC40	2 1/2IN. ALUM. CUSH.CLAMP (Option: Gray Water System)	4	EA
Not Pictured	6724-5	#24 HOSE CLAMP (1-2) (Option: Gray Water System)	12	EA
Not Pictured	6716-5	#16 HOSE CLAMP(3/4-1 1/2) (Option: Gray Water System)	1	EA
Not Pictured	6708-5	#8 HOSE CLAMP (7/16-1) (Option: Gray Water System)	3	EA
Not Pictured	F06800	1/2P X 1/2P 90 DEG. ELBOW (Option: Vac Generator)	1	EA
Not Pictured	1943-1B	BLK CAP LG. .045 X .465 (Option: Gray Water System)	2	EA

NOTE: Numbers with letter designations represent parts included with primary numbered part for which there is no photo representation.

PARTS IDENTIFICATION GUIDE

SIGNATURE 270

2004 MODEL YEAR

Canvas

Part Number	Description	Qty.	U.O.M.
102776---	S270 BIM TOP KIT	1	EA
102782---	S270 CONNECTOR	1	EA

OPTION: CANVAS PACK:

103007---	S270 CMPR AFT CURTAIN	1	EA
102783---	S270 SIDE CURTAIN	1	SET
101202---	STORAGE BAG MED	1	EA

OPTION: CANVAS PACK:W/RADAR ARCH

101202 - - -	STORAGE BAG (MED)	1	EA
102329 - - -	S270 SIDE CURT W/ARCH	1	SET
102384 - - -	S270 CMPR SYS W/ARCH	1	EA

OPTION: COCKPIT COVER

102784 - - -	S270 COCKPIT COVER	1	EA
--------------	--------------------	---	----

OPTION: COCKPIT COVER W/RADAR ARCH

102334 - - -	S270 C/PIT CVR W/ARCH	1	EA
--------------	-----------------------	---	----

Note: To identify canvas color selections place the color designations below into the spaces provided in the part numbers.

522 - Marine Blue

008 - Black

020 - Beige

030 - Burgundy

PARTS IDENTIFICATION GUIDE

270 SIGNATURE

2004 MODEL YEAR

OVERHEAD VIEW

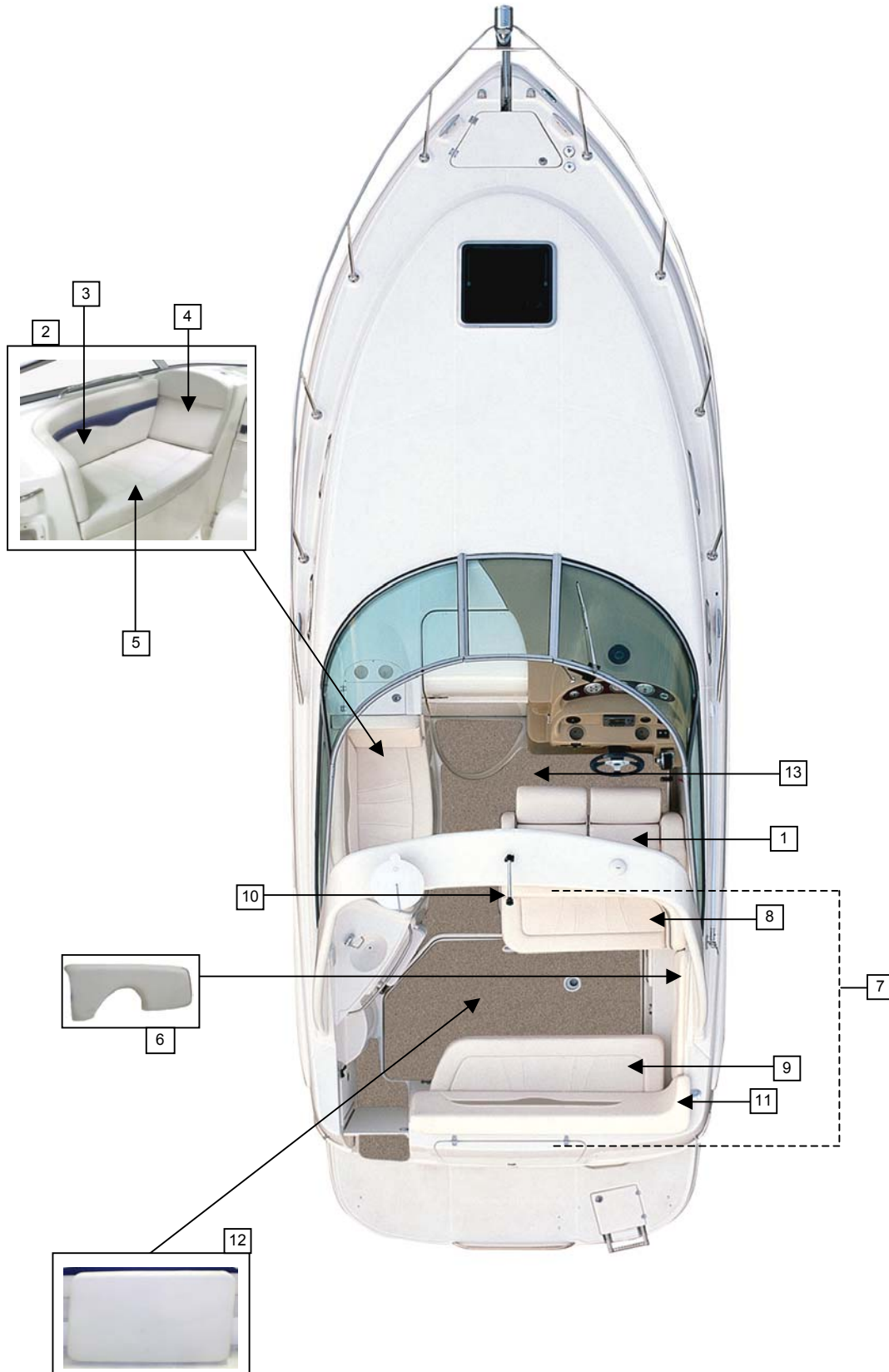

PARTS IDENTIFICATION GUIDE

270 SIGNATURE

2004 MODEL YEAR

OVERHEAD VIEW

Item No.	Part Number	Description	Qty.	U.O.M.
1	401422INT	Helm Seat Assembly	1	ea
1a	401422INT-S	Helm Seat Assembly Skin	1	ea
1b	401423INT	Helm Seat Base	1	ea
1c	401423INT -S	Helm Seat Base Skin	1	ea
1d	401424INT	Helm Seat Headrest	1	ea
1e	401424INT-S	Helm Seat Headrest Skin	1	ea
1f	401425INT	Helm Seat Backrest	1	ea
1g	401425INT-S	Helm Seat Backrest Skin	1	ea
1h	401426INT	Helm Seat Cushion	2	ea
1i	401426INT-S	Helm Seat Cushion Skin	2	ea
1j	401427INT	Helm Seat Flip Up Cushion	2	ea
1k	401427INT-S	Helm Seat Flip Up Cushion Skin	2	ea
2	401428INT	Port Seat Assembly	1	ea
2a	401428INT-S	Port Seat Assembly Skin	1	
3	401429INT	Port Seat Backrest	1	ea
3a	401429INT-S	Port Seat Backrest Skin	1	ea
4	401430INT	Port Seat Headrest	1	ea
4a	401430INT-S	Port Seat Headrest Skin	1	ea
5	401431INT	Port Seat Cushion	1	ea
5a	401431INT-S	Port Seat Cushion Skin	1	ea
6	401432INT	Cockpit Side Panel	1	ea
7	401433INT	Stern Seating Assembly	1	ea
7a	401433INT-S	Stern Seating Assembly Skin	1	ea
7b	A-60300X48	48 In Blk Anodi/S-2 F-1 Alm	1	ea
7c	SC-WTP-SR	Seat Cleat White	3	ea
7d	CB30048-F	3 X 48 2370,28,30,32) Hinge	1	ea
7e	35214	280/350 Swing Down Leg	2	ea
8	401434INT	Forward Cockpit Cushion	1	ea
8a	401434INT-S	Forward Cockpit Cushion Skin	1	ea
9	401435INT	Stern Cockpit Cushion	1	ea
9a	401435INT-S	Stern Cockpit Cushion Skin	1	ea
9b	401492INT	Stern Cushion Hinge Board	1	ea
10	401436INT	Starboard Forward Backrest	1	ea
10a	401436INT-S	Starboard Forward Backrest Skin	1	ea
11	401437INT	Aft Backrest	1	ea
11a	401437INT-S	Aft Backrest Skin	1	ea
12	401483INT	Cockpit Filler Cushion	1	ea
12a	401483INT-S	Cockpit Filler Cushion Skin	1	ea
13	401484SNC	Cockpit Snap In Carpet	1	ea
13a	45-0450BNKL	24 Socket Nickel	24	ea
13b	05-00004	Buckskin Long Barrel Cap (for Champagne Interior)	24	ea
13c	45-0401BNKL	24 Long Barrel Nickel (for Platinum Interior)	24	ea
13d	CLRSTR	4 1/2" X 1" Plastic Strip	24	ea
13e	20045100	Carpet Grommet 3 5/8"	1	ea

*For part numbers with an "INT", "OPT" or "SNC" suffix,
add "-901" extension for a CHAMPAGNE boat; "-902" for PLATINUM boat.*

**NOTE: Numbers with letter designations represent parts included with
primary numbered part for which there is no photo representation.**

PARTS IDENTIFICATION GUIDE

270 SIGNATURE

2004 MODEL YEAR

BOW INTERIOR

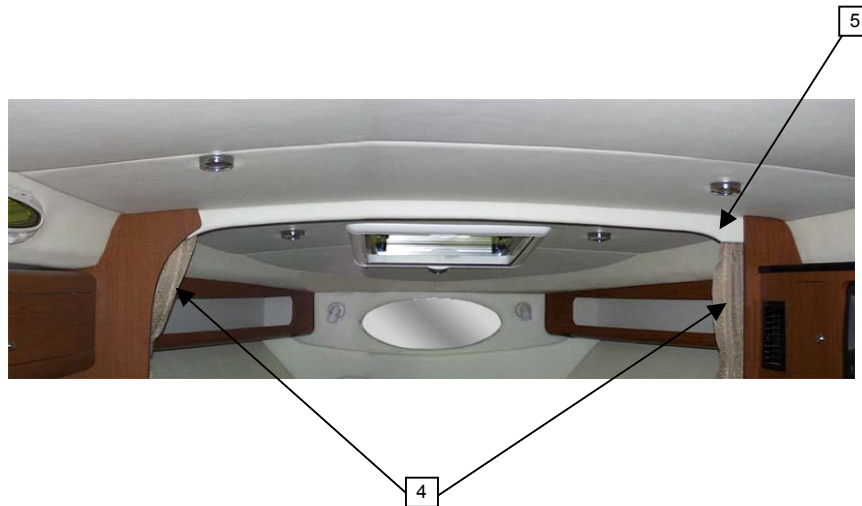

PARTS IDENTIFICATION GUIDE

270 SIGNATURE

2004 MODEL YEAR

BOW INTERIOR

Item No.	Part Number	Description	Qty.	U.O.M.
1	401454INT	Forward Bow Cushion	1	ea
1a	401454INT-S	Forward Bow Cushion Skin	1	ea
2	401458INT	Bow V-Berth Retainer Pad	1	ea
2a	401458INT-S	Bow V-Berth Retainer Pad Skin	1	ea
3	401495INT	V-Berth Step	1	ea
3a	401495INT-S	V-Berth Step Skin	1	ea
4	401488INT	Forward Privacy Curtain	1	ea
5	401460INT	V-Berth Curtain Track	1	ea
5a	401460INT-S	V-Berth Curtain Track Skin	1	ea

NOTE: Numbers with letter designations represent parts included with primary numbered part for which there is no photo representation.

PARTS IDENTIFICATION GUIDE

270 SIGNATURE

2004 MODEL YEAR

DINETTE/AFT CABIN

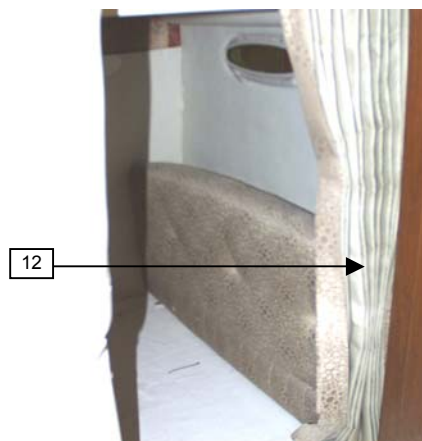
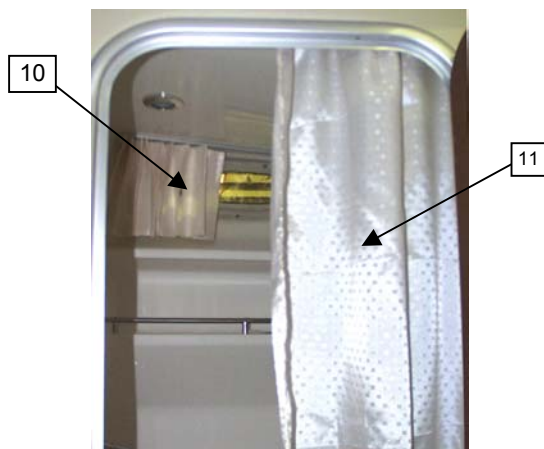
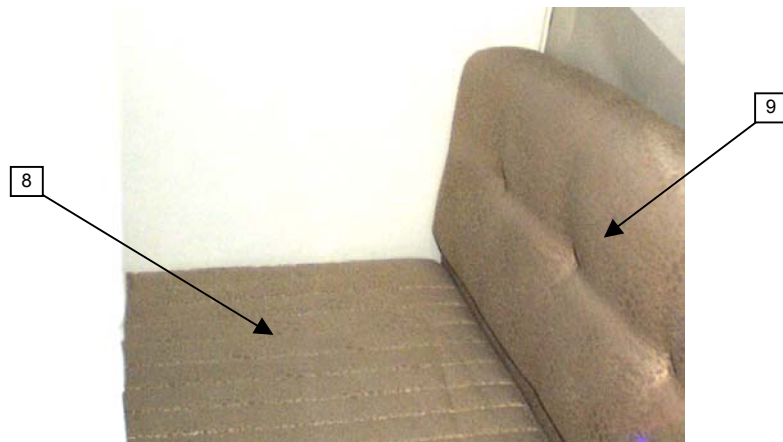
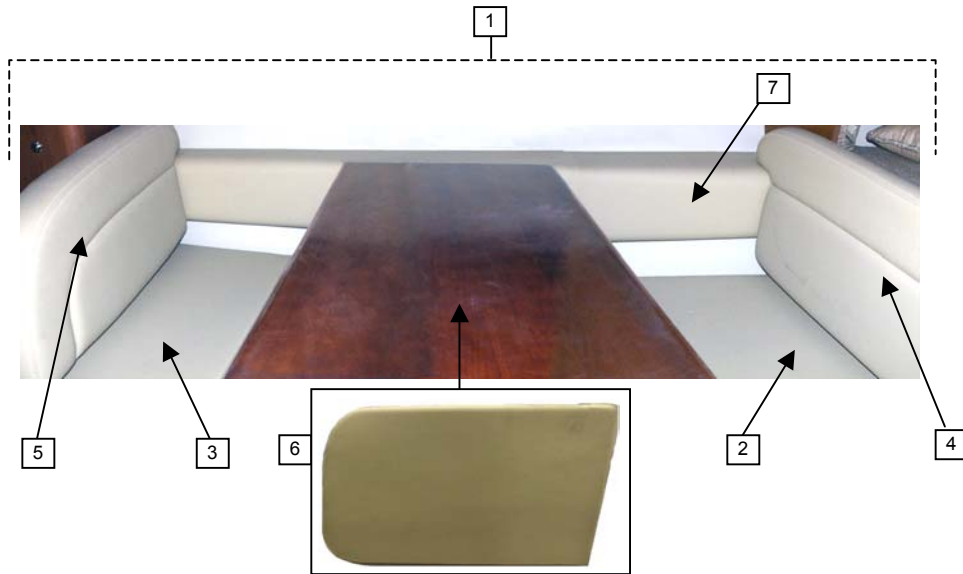

PARTS IDENTIFICATION GUIDE

270 SIGNATURE

2004 MODEL YEAR

DINETTE/AFT CABIN

Item No.	Part Number	Description	Qty.	U.O.M.
1	401438INT	Dinette Seating Assembly	1	ea
1a	401438INT-S	Dinette Seating Assembly Skin	1	ea
2	401439INT	Forward Dinette Cushion	1	ea
2a	401439INT-S	Forward Dinette Cushion Skin	1	ea
3	401440INT	Aft Dinette Cushion	1	ea
3a	401440INT-S	Aft Dinette Cushion Skin	1	ea
4	401441INT	Forward Dinette Backrest	1	ea
4a	401441INT-S	Forward Dinette Backrest Skin	1	ea
5	401442INT	Aft Dinette Backrest	1	ea
5a	401442INT-S	Aft Dinette Backrest Skin	1	ea
6	401482INT	Dinette Filler Cushion	1	ea
6a	401482INT-S	Dinette Filler Cushion Skin	1	ea
6b	400301T	Dinette Cushion Tubing	1	ea
7	401443INT	Dinette Arm Rest	1	ea
7a	401443INT-S	Dinette Arm Rest Skin	1	ea
8	401453INT	Aft Bunk Cushion	1	ea
8a	401453INT-S	Aft Bunk Cushion Skin	1	ea
9	401447INT	Aft Cabin Head Board	1	ea
9a	401447INT-S	Aft Cabin Head Board Skin	1	ea
10	401493INT	Head Window Curtain	1	ea
11	401487INT	Shower Curtain	1	ea
12	401489INT	Aft Privacy Curtain	1	ea
not pictured	401470INT	Aft Berth Mirror	1	ea
not pictured	401494TC	Dinette Table Cover	1	ea
not pictured	401485SNC	Cabin Snap In Carpet	1	ea

NOTE: Numbers with letter designations represent parts included with primary numbered part for which there is no photo representation.

PARTS IDENTIFICATION GUIDE

270 SIGNATURE

2004 MODEL YEAR

CEILING/HEADLINER BOARDS

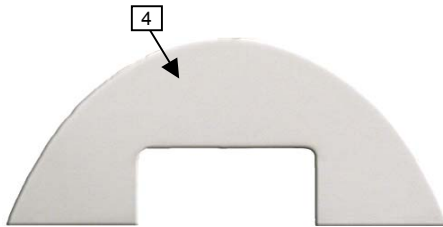
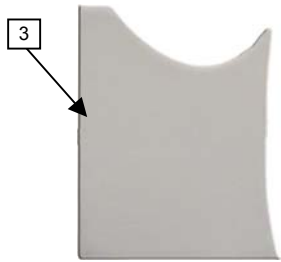
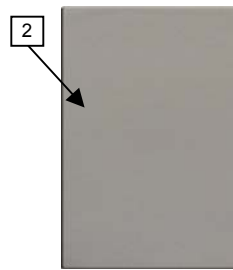
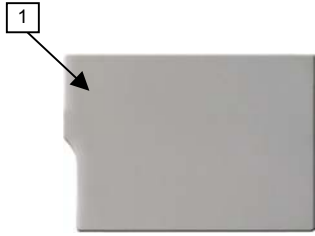

PARTS IDENTIFICATION GUIDE

270 SIGNATURE

2004 MODEL YEAR

CEILING/HEADLINER BOARDS

Item No.	Part Number	Description	Qty.	U.O.M.
1	401463INT	Aft Entry Ceiling Pad	1	ea
1a	401463INT-S	Aft Entry Ceiling Pad Skin	1	ea
2	401464INT	Aft Berth Starboard Ceiling Pad	1	ea
2a	401464INT-S	Aft Berth Starboard Ceiling Pad Skin	1	ea
3	401465INT	Aft Berth Center Ceiling Panel	1	ea
3a	401465INT-S	Aft Berth Center Ceiling Panel Skin	1	ea
4	401466INT	Forward Bow Ceiling Panel	1	ea
4a	401466INT-S	Forward Bow Ceiling Panel Skin	1	ea
5	401467INT	Aft Berth Port Ceiling Panel	1	ea
5a	401467INT-S	Aft Berth Port Ceiling Panel Skin	1	ea
6	401468INT	Center Ceiling Panel	1	ea
6a	401468INT-S	Center Ceiling Panel Skin	1	ea
7	401469INT	Aft Head Ceiling Panel	1	ea
7a	401469INT-S	Aft Head Ceiling Panel Skin	1	ea
8	401444INT	Aft Entry Way Curtain Track	1	ea
8a	401444INT-S	Aft Entry Way Curtain Track Skin	1	ea
9	401446INT	Aft Berth Wire Cover Board	1	ea
9a	401446INT-S	Aft Berth Wire Cover Board Skin	1	ea
10	401496INT	Aft Berth Entry Way End Cap	1	ea
10a	401496INT-S	Aft Berth Entry Way End Cap Skin	1	ea

NOTE: Numbers with letter designations represent parts included with primary numbered part for which there is no photo representation.

PARTS IDENTIFICATION GUIDE

270 SIGNATURE

2004 MODEL YEAR

HEADLINER BOARDS (cont'd)

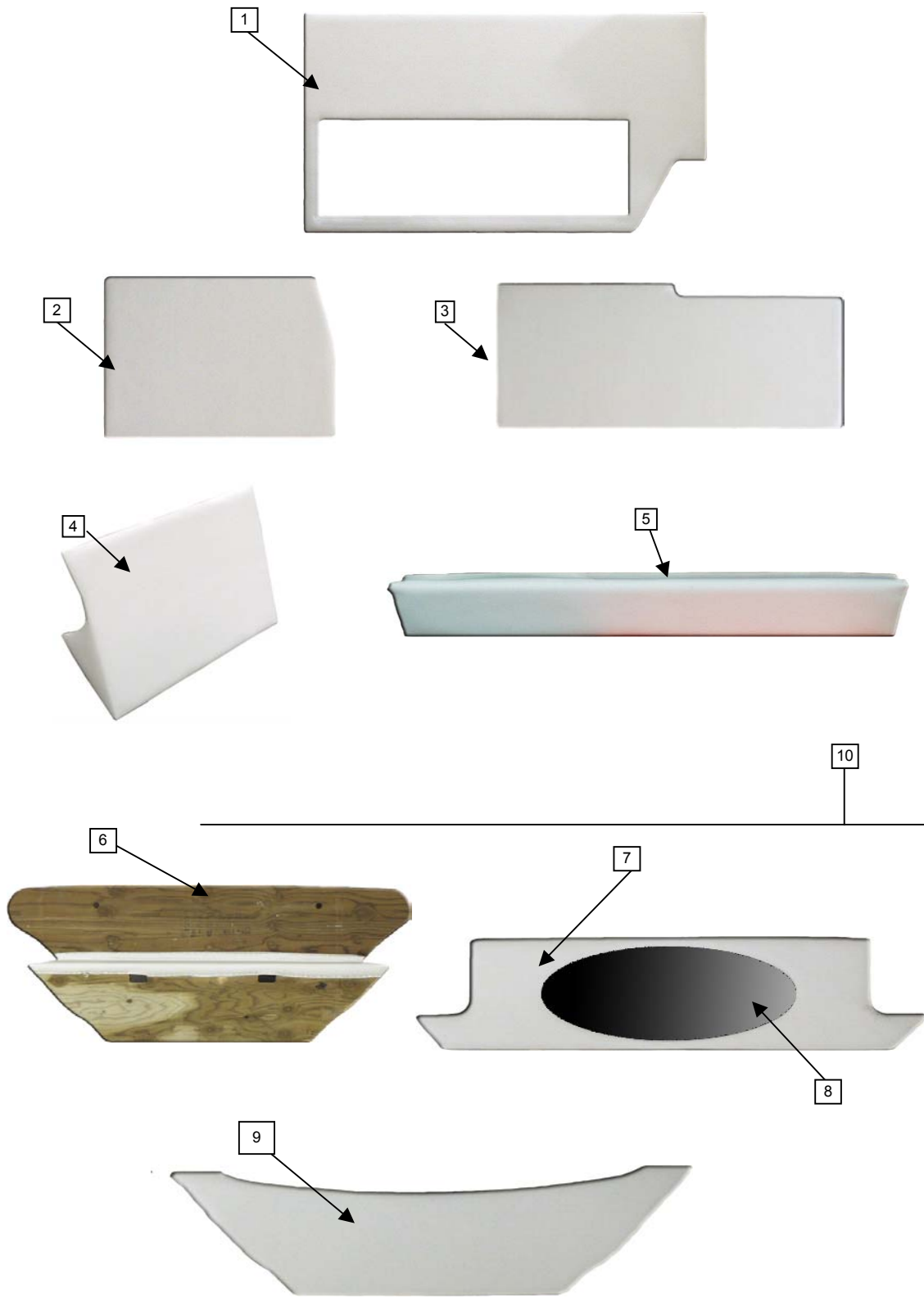

PARTS IDENTIFICATION GUIDE

270 SIGNATURE

2004 MODEL YEAR

HEADLINER BOARDS (cont'd)

Item No.	Part Number	Description	Qty.	U.O.M.
1	401448INT	Aft Berth Cabinet Bulkhead	1	ea
1a	401448INT-S	Aft Berth Cabinet Bulkhead Skin	1	ea
2	401449INT	Aft Entry Way Ceiling Pad	1	ea
2a	401449INT-S	Aft Entry Way Ceiling Pad Skin	1	ea
3	401450INT	Aft Berth Entry Bulkhead	1	ea
3a	401450INT-S	Aft Berth Entry Bulkhead Skin	1	ea
4	401451INT	Aft Berth Angle Ceiling Pad	1	ea
4a	401451INT-S	Aft Berth Angle Ceiling Pad Skin	1	ea
5	401459INT	Entry Way Pad	1	ea
5a	401459INT-S	Entry Way Pad Skin	1	ea
6	401455INT	Forward Bow Bulkhead	1	ea
6a	401455INT-S	Forward Bow Bulkhead Skin	1	ea
7	401456INT	Forward Bow Mirror Board	1	ea
7a	401456INT-S	Forward Bow Mirror Board Skin	1	ea
8	401461INT	Forward Bow Mirror	1	ea
9	401491INT	Forward Bow Bulkhead Pad	1	ea
9a	401491INT-S	Forward Bow Bulkhead Pad Skin	1	ea
10	401490INT	Forward Bow Bulkhead Assembly	1	ea
10a	401490INT-S	Forward Bow Bulkhead Assembly Skin	1	ea

NOTE: Numbers with letter designations represent parts included with primary numbered part for which there is no photo representation.

PARTS IDENTIFICATION GUIDE

270 SIGNATURE

2004 MODEL YEAR

CARPET/OTHER BOARDS



PARTS IDENTIFICATION GUIDE

270 SIGNATURE

2004 MODEL YEAR

CARPET/OTHER BOARDS

Item No.	Part Number	Description	Qty.	U.O.M.
1	401452INT	V-Berth Hatch	1	ea
1a	401452INT-S	V-Berth Hatch Skin	1	ea
2	401457INT	V-Berth Bulkhead	1	ea
2a	401457INT-S	V-Berth Bulkhead Skin	1	ea
3	401445INT	Aft Hose Cover Board	1	ea
3a	401445INT-S	Aft Hose Cover Board Skin	1	ea
4	401462INT	Aft Berth Bulkhead Cleat	1	ea

NOTE: Numbers with letter designations represent parts included with primary numbered part for which there is no photo representation.