

Signature 310

PARTS IDENTIFICATION GUIDE INDEX

SIGNATURE 310

2006 MODEL YEAR

<u>DESCRIPTION</u>	<u>ID. PAGE NO.</u>	<u>DESCRIPTION PAGE NO.</u>
Deck - Overhead View (includes the following)	8	9
Anchor Lid & Hardware		
Bow Rails		
Cleats		
Deck Hatches		
Deck Pad Components		
Forward Deck Drink Holders		
Hinged Radar Arch		
King Plank Rails		
Masthead/Anchor Light		
Navigation Lights		
Radar Arch & Components		
Rod Holders Option		
Spotlight		
Water/Waste Deck Fittings		
Windlass		
Hull/Deck Exterior (includes the following)	10, 12, 14	11, 13, 15
Aft Exterior Grab Rails		
Bow Chafe		
Bow Eye		
Cleats		
Drain Plug		
Fiberglass Antenna & Components		
Fuel Fitting		
Horn		
Jump Start Charger		
Portlights		
Rubrail & Insert		
Shore Power		
Swim Platform & Components		
Thru Hulls		
Transom Door		
Transom Lights		
Transom Shower		
Transom Stereo Remote		
Trim Tabs		
Trunk/Dunnage Compartment Components		
Vents & Vent Covers		
Waste Vent		
Graphics (includes the following)	16	17
Bird Head Logo		
Boat and Yacht NMMA Label		
Chaparral Lettering & Bird		
Deck Tapes		
Extended V-Hull Decal		
Hull Flares		
Hull Tapes		
Model Designator & Chrome Designator		
Protected Design Decal		
Warranty Decal		
Wide Band Gel Coat		
Dash / Helm (includes the following)	18	19, 21, 23
Cabin Door		
Compass		
Console Remote		
Depth Finder		
Fire Extinguisher Light		
GPS		
Helm Seat Storage		
Instrument/Switch Panels		
Port & Stbd Consoles		
Shifter & Engine Components		
Sliding Cabin Door Option		
Steering Cable		
Steering Wheel & Tilt Helm		
VHF Radio		
Windshield Wiper		

PARTS IDENTIFICATION GUIDE INDEX

SIGNATURE 310

2006 MODEL YEAR

<u>DESCRIPTION</u>	<u>ID. PAGE NO.</u>	<u>DESCRIPTION PAGE NO.</u>
Cockpit (includes the following) Access Doors Battery Panel Cockpit Galley Components Cockpit Refrigerator Option Cup Holders Engine Lid Channel Igloo Cooler Motor Lids Owner's Manual & Info Bag Port Dash Components Rubbermaid Waste Basket Speaker Upgrade Speakers Table & Storage Transom Lights Waste Fitting	24, 26	25, 27
Forward Cabin (includes the following) Bunk Storage Cabin Lighting Carbon Monoxide Detector Cupholders Dinette Table, Hardware, & Storage Speaker Upgrade W/Amp Stereo Components Subwoofer Television Wiring TV/DVD Player	28, 30	29, 31
Aft Cabin (includes the following) 6 Disc CD Changer Aft Cabin Table & Hardware Aft Cabin TV Option Aft Cabin Window Cabin Steps Filler Cushion Hardware Floor Hatches Storage Tubs	32	33
Galley (includes the following) AC Panel & Door Circuit Breaker Panel Coffee Maker Faucet Galvanic Isolator Grab Rails Indirect Lighting Microwave Outlets Refrigerator Sink & Drain Stove & Rail Kit TV & Wiring Waste Basket Water Pressure Panel	34	35
Head (includes the following) Access Door & Hardware Faucet Grab Rails Head Door Hardware Head Lighting Head Panel Outlets Port Light Shower Drain Sink & Drain Tissue Holder Toilet Towel Sets Ventilation	36	37

PARTS IDENTIFICATION GUIDE INDEX

SIGNATURE 310

2006 MODEL YEAR

<u>DESCRIPTION</u>	<u>ID. PAGE NO.</u>	<u>DESCRIPTION PAGE NO.</u>
Air Conditioning (includes the following) 110v Air Conditioning Kit 220v Air Conditioning Kit	38, 40	39, 41
Cabinets (includes the following) Aft Berth Hanging Locker Aft Berth Storage Cabinet Counter Top & Inserts Dinette Overhead Cabinet Assembly Dinette Shelf Assembly Galley Cabinet Galley Hanging Locker Head Door Medicine Cabinet Microwave Cabinet Mirrors V-Berth Drawer Assembly V-Berth Storage Cabinets	42, 44, 46, 48	43, 45, 47, 49
Deck - Underside View (includes the following) Motor Well Boots Blower Vent Hoses Cupholder Tub Drains & Hoses Engine Compartment Lighting Helm Seat Storage Oil Discharge Faceplate	50, 52	51, 53
Engine Well (includes the following) Actuator Battery Boots & Trays Battery Charger Bilge Drain Hoses Bilge Pumps Blowers & Blower Hoses CE Manual Bilge Pump Depth Finder Thru Hull Transducer Engine Well Bulkhead Sound Foam Fire Extinguisher Float Switches Fuel Lines Fuel Tank Gas Vapor Detector Generator Option Hot Water Heater International Fuel Shut Off Option Shower Sump Shurflo Pump Vacuflush Kits Volvo Seakey Water Heater Hoses Water Tank	54, 56	55, 57
Battery Cable Routing (includes the following) Standard Battery Cables Battery Cables With Generator Option	58	59
Generator Options (includes the following) 120V Gasoline Generator 220V Gasoline Generator 120V Diesel Generator 220V Diesel Generator	N/A	61
Fresh Water (includes the following) Water Hoses, Fittings, Pump & Filter	62	63
Waste System (includes the following) Gray Water System Option Waste & Sink Hoses & Fittings Waste Holding Tank & Components	64	65

PARTS IDENTIFICATION GUIDE INDEX

SIGNATURE 310

2006 MODEL YEAR

<u>DESCRIPTION</u>	<u>ID. PAGE NO.</u>	<u>DESCRIPTION PAGE NO.</u>
Interiors - Overhead View (includes the following) Deck Pad Port Cockpit Seating Assembly Snap In Cockpit Carpet Stern Filler Cushion Stern Seating Assembly	66	67
Interiors - Helm Seat (includes the following) Helm Seat Assembly	68	69
Interiors - Forward Bow (includes the following) Bow Bunk Cushion Forward Bulkhead Assembly Galley Curtain Head Window Curtain Pillow Packages Shower Curtain Snap In Cabin Carpet V-Berth Backrest Assembly V-Berth Privacy Curtain V-Berth Retainer Pad	70	71
Interiors - Dinette (includes the following) Cabinet C-Rails Dinette Curtain Dinette Seating Assembly Filler Cushion Shelf Pad Table Cover	72	73
Interiors - Aft Cabin (includes the following) Aft Berth Curtain Aft Cabin Base Aft Cabin Seating Assembly Filler Cushions Shadow Box Assembly Snap In Carpet	74	75
Interiors - Headliner Boards (includes the following) Ceiling Pads Close Out Panels Curtain Bulkhead Assembly Curtain Tracks Entry Wall	76	77
Interiors - Carpet Boards (includes the following) Aft Berth Locker Close Out Dinette Close Out Board Pull Out Storage Boards V-Berth Close Out V-Berth Hatch	78	79
AC Kits (120V & 220V)	80, 82-85	81

Signature 310

PARTS IDENTIFICATION GUIDE

SIGNATURE 310
2006 MODEL YEAR

Deck-Overhead View

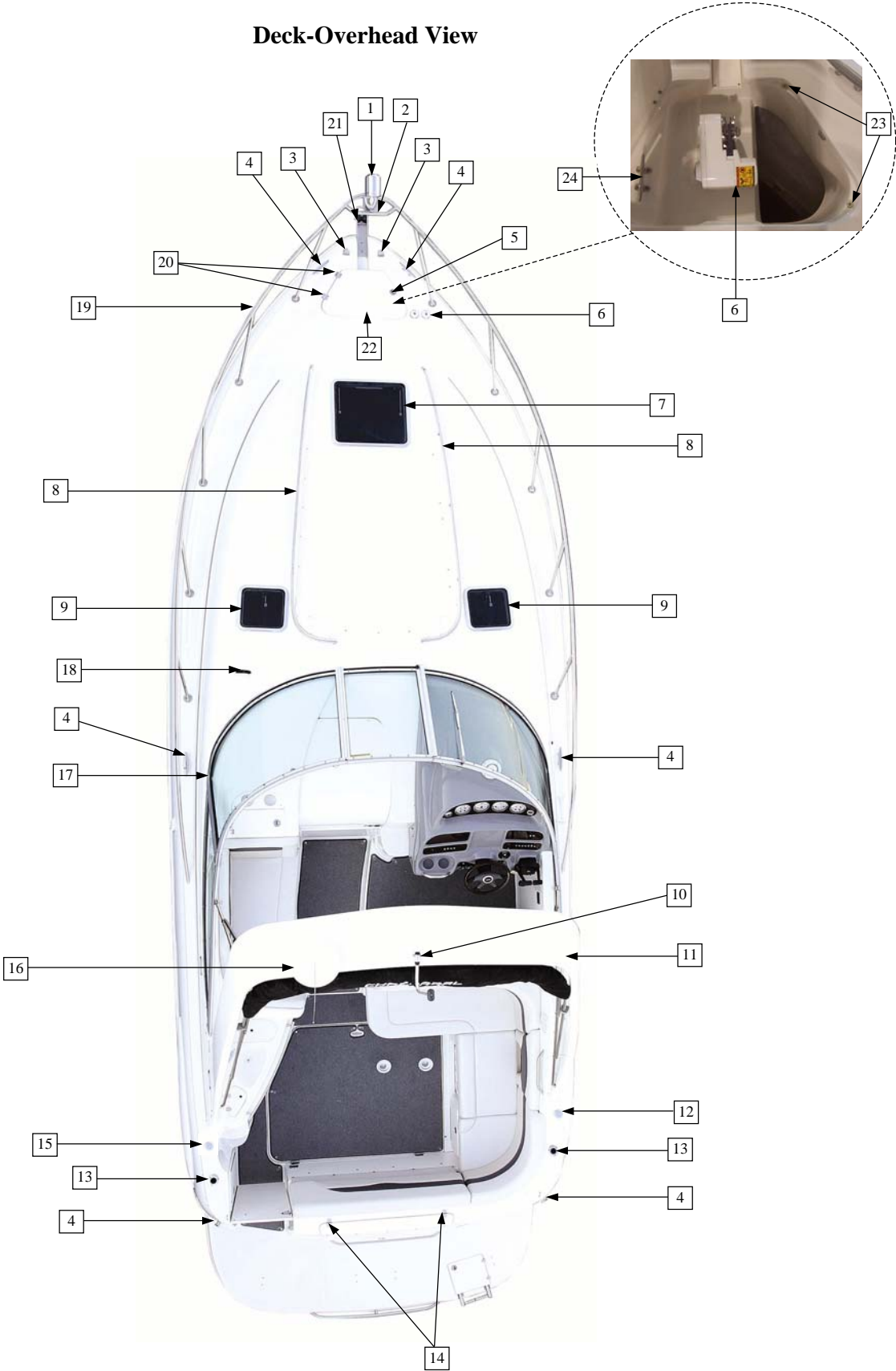

PARTS IDENTIFICATION GUIDE**SIGNATURE 310****2006 MODEL YEAR****Deck-Overhead View**

Item No.	Part Number	Description	Qty.	U.O.M.
1	62026-4705	SPOTLIGHT W/ CONTROL	1	EA
1a	67492-0800	SPOTLIGHT CABLE	26	FT
2	35251	FWD SECTION W/LIGHT	1	EA
3	66319-1	HORIZONTAL SIDELIGHT	1	PR
4	SSCL-66010-2SE	8IN EURO STYLE CLEAT	6	EA
5	M1-62-8	LATCH/FLUSH SS	1	EA
6	69600612	WINDLASS PRO-SERIES 1000 KIT (Option: Windlass)	1	EA
6a	203-00031-B	S310 WINDLASS HARNESS (Option: Windlass)	1	EA
6b	212N2V02	BATTERY BOOT (Option: Windlass)	2	EA
7	588-1020010	HATCH 22X22 W/OUT RING AND SCREEN	1	EA
7a	SFSS-22/22-R42	22X22 SURFACE SKYSCREEN	1	EA
8	35238	S310 KING PLANK RAILS	1	SET
9	588-1020012	13 X 13 HATCH W/OUT RING AND SCREEN	2	EA
9a	SFSSL-321/321-B	12 5/8 X 12 5/8 SKYSCREEN BEIGE	2	EA
10	1273SPL003	LIGHT-MASTHEAD/ANCHOR 18" OAH W/ 90 DEG. BEND	1	EA
10a	IST34329	MAST HEAD ANCHOR LIGHT SHIM	1	EA
11	2600010	ARCH - 310 SIG ALUMINUM RADAR	1	EA
11a	6356P1 81230-WR-PACK	TRANSOM LIGHT W/PACK.PLUG	2	EA
11b	CVR64AW	COVER PLATE 6 INCH WHITE	2	EA
11c	255-256	HINGED RADAR ARCH BRACKETS (Option: Hinged Radar Arch)	2	EA
11d	2600029	ARCH - HINGED 310 SIG ALUMINUM (Option: Hinged Radar Arch)	1	EA
11e	98404A505	PIN - QUICK RELEASE SS RING GRIP 1/2 (Option: Hinged Radar Arch)	2	EA
11f	U22778-01	DECAL - DANGER SECURE ARCH LABEL (Option: Hinged Radar Arch)	1	EA
12	540-WOO-CHR	WATER FILL/VENT FITTING	1	EA
13	66362-1	ROD HOLDER (Option :Rod Holders)	2	EA
14	1174	2.875 X 1.5 INCH HINGE	2	EA
15	556-SPL-003	WASTE FITTING W/RETAINER	1	EA
16	GAZ-360	ARCH ANTENNA	1	EA
17	588104000302	WINDSHIELD - S310 - NEW EXT.W/VADNEY FEATURE- 3PC.	1	EA
17a	33105	14 IN CURVED BLADE	1	EA
17b	33110A	DLX WIPER ARM	1	EA
17c	35289	WINDSHIELD - BRACE S310 - ADJUSTABLE	1	SET
18	41-00002	MAGNETIC WINDOW HOLDER SS 20X10 STRIKE	1	EA
19	35253	290SIG BOW RAIL	1	EA
20	H20-0200	2 INCH BUTT HINGE	2	EA
21	URM-4GB	BOW ROLLER LARGE HIGH POLISH	1	EA
21a	IST14257	S310 ANCHOR CHAIN GUARD	1	EA
21b	HM30B200PX	5/8 8/PLAITED ANCHOR RODE 200FT ROPE (Option: Windlass)	1	EA
21c	SL0057410/F	22LB. DELTA ANCHOR (Option: Custom Anchor)	1	EA
21d	SS180002	ANCHOR SAFETY STRAP 15 1/4 310-330-350 (Option: Custom Anchor)	1	EA
22	3-1078	350/330/310SIG ANCHOR LOCKER LID	1	EA
22a	HRA8-GR12-CUT	LOCKER MATTING 8IN X 12IN (Inside Anchor Locker)	1	EA
22b	U13770-01	DANGER ANCHOR MAY MOVE LABEL (Inside Anchor Locker)	1	EA
23	5168	WASHER (CLEAR) (Inside Anchor Locker)	2	EA
24	66009-1	6 INCH CLEAT - HOLLOW BASE (Inside Anchor Locker)	1	EA

11g 28-00014 TRIM - VINYL AWNING TRACK FOR ARCH 20 FT (Arch Canvas Track) 2 EA

Parts Not Pictured Which Are Associated With Deck-Overhead:

Not Pictured	1123SPL009	BASE FOR POLE LIGHT	1	EA
Not Pictured	6722	STAINLESS RUB STRIKE	1	EA
Not Pictured	310601	310SIG PORT DRINK HOLDER (Aft Corner of King Plank Rail)	1	EA
Not Pictured	310602	310SIG STBD. DRINK HOLDER (Aft Corner of King Plank Rail)	1	EA
Not Pictured	U13778-01	NOTICE SECURE WINDSHIELD DOOR LABEL	1	EA
Not Pictured	28-00004	TRIM - AWNING TRACK WHITE 6 FT (Option: Deck Pad)	0.50	EA
Not Pictured	14005	3/8IN SCREW STUD SS (Option: Deck Pad)	14	EA
Not Pictured	U18398-01	SUNPAD WARNING LABEL (Option: Deck Pad)	1	EA

NOTE: Numbers with letter designations represent parts included with primary numbered part for which there is no photo representation.

PARTS IDENTIFICATION GUIDE

SIGNATURE 310
2006 MODEL YEAR

Hull / Deck Exterior

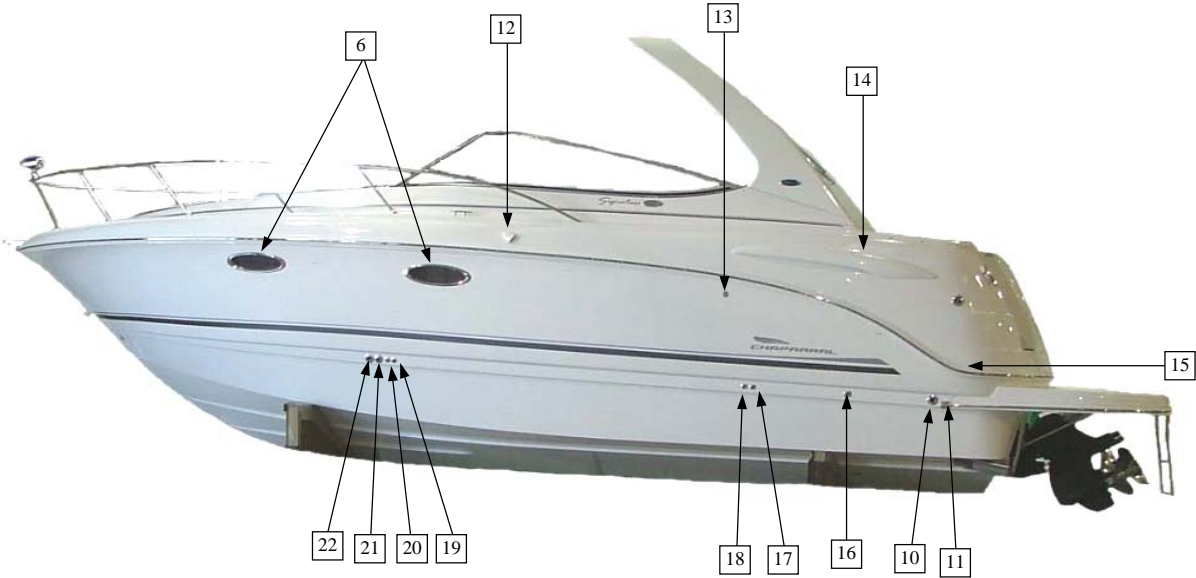
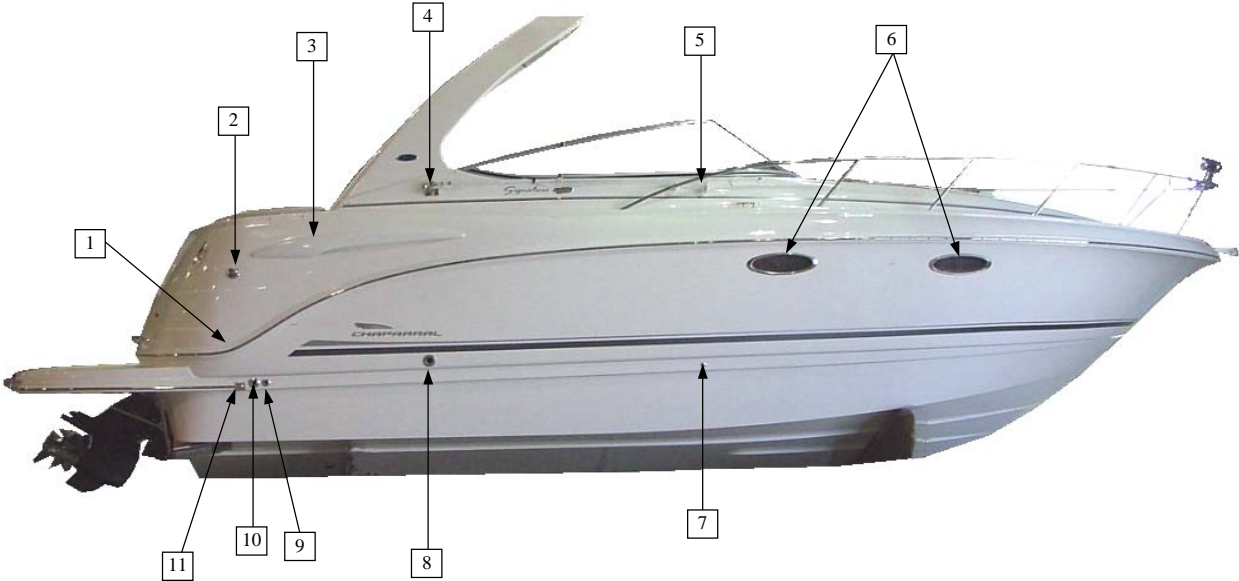

PARTS IDENTIFICATION GUIDE**SIGNATURE 310****2006 MODEL YEAR****Hull / Deck Exterior**

Item No.	Part Number	Description	Qty.	U.O.M.
1	STA75#310CNRS	S310 STBD PREBENT INSERT	1	EA
2	540-SPL-004 540-GOO-CHR	GAS FILL/VENT(25)	1	EA
3	064B	STBD VENT	1	EA
3a	VHF-4WS	4 IN. SAND FLANGE	2	EA
3b	VHF-3WS	3 IN. SAND FLANGE	4	EA
4	RA1206	8 FT. FIBERGLASS ANTENNA	1	EA
4a	6520S	SS ANTENNA MOUNT	1	EA
4b	4600W	ANTENNA CLEAT	1	EA
4c	2340-840	MIDGET VENT 1 1/2 X 1 3/4	1	EA
5	11104	MINI AIR HORN WHITE	1	EA
6	JB518SSCH	5 X 18 PORTLIGHT CUST COL	3	EA
7	71001	5/8IN (1/2IN) SS THRU HULL (Option: Air Conditioning)	1	EA
8	71008	2 IN SS THRU HULL (Option: Generator)	1	EA
9	71004	1 1/8IN SS THRU HULL BARB (Aft Bilge Drain)	1	EA
10	71006	1 1/2IN SS THRU HULL BARB (Liner Drain)	2	EA
11	B-01336	LG. SS RUBRAIL END CAP	1	PR
12	281020020	2 INCH VENT COVER	1	EA
13	954	VENT- SS FLUSH MOUNT W/ 90 DEGREE 5/8 ELBOW (Waste Vent)	1	EA
14	064A	PORT VENT	1	EA
15	STA75#310CNRP	S310 PORT PREBENT INSERT	1	EA
16	71003	1IN SS THRU HULL BARB (Option:Macerator)	1	EA
17	71002	3/4IN SS THRU HULL BARB (Ckpit Galley Drain)	1	EA
18	71002	3/4IN SS THRU HULL BARB (Port Seat Drain)	1	EA
19	71002	3/4IN SS THRU HULL BARB (Sump Pump Drain)	1	EA
20	71002	3/4IN SS THRU HULL BARB (Fwd Bilge Drain)	1	EA
21	71005	1 1/4IN SS THRU HULL BARB (Head Sink Drain)	1	EA
22	71006	1 1/2IN SS THRU HULL BARB (Galley Sink Drain)	1	EA

NOTE: Numbers with letter designations represent parts included with primary numbered part for which there is no photo representation.

PARTS IDENTIFICATION GUIDE

SIGNATURE 310
2006 MODEL YEAR

Hull / Deck Exterior



PARTS IDENTIFICATION GUIDE**SIGNATURE 310****2006 MODEL YEAR****Hull / Deck Exterior**

Item No.	Part Number	Description	Qty.	U.O.M.
1	8293	SIG. 310 ANCHOR CHAFE PLATE	1	EA
2	STESW1003	1/2 X 3 7/16 BOW EYE	1	EA
3	71004	1 1/8IN SS THRU HULL BARB	1	EA
4	35261	SWIM PLATFORM GRAB RAIL 280 SIG	1	EA
5	2264	2 1/2 SS LIFT HANDLE LOCK	1	EA
6	3-1090	290/310SIG TRUNK LID	1	EA
7	SP67	SWIM PLATFORM LID/DIAMOND	1	EA
7a	M1-62-8	LATCH/FLUSH SS (Swim Platform Lid)	1	EA
7b	2640	1.18 X 1.82 FM HINGE (Swim Platform Lid)	2	EA
8	TDL-3XP	3 STEP LADDER W/HAND GRIP	1	EA
9	U13772-01	DANGER USING BOARDING LADDER LABEL	1	EA
10	PS-12	32 IN. PLATFORM BRACE (Outboard Swim Platform Brace)	2	EA
11	35235	310S SWIM PLATFORM RAIL	1	EA
12	PS-18	38 INCH PLATFORM BRACE (Inboard Swim Platform Brace)	2	EA
13	U15925-01 U23506-01	SWIM PLATFORM LABEL (700 LBS)	1	EA
14	STA75I109.25	SS INSERT 3/4 X 109 1/4IN	2	EA
14a	V21-9747CRA40D	RUBRAIL, 2 1/8 RIGID VINYL WHITE 40FT.	2.5	EA
14b	STA2416H12	SS INSERT 3/4 X 12	3	EA
14	STA75I100.5	100.5 INCH SS INSERT	1	EA
15	3-1200	310SIG SWIM PLATFORM	1	EA

Parts Not Pictured Which Are Associated With Hull / Deck Exterior:

Not Pictured	71006	1 1/2IN SS THRU HULL BARB (CE Pkgs)	1	EA
Not Pictured	714-1-PLB	DRAIN PLUG	1	EA
Not Pictured	U13340-01	0.624 X 2 SLING DECAL 4MIL WHT/BLK	4	EA
Not Pictured	U16852-01	WINTERIZED LABEL	1	EA

NOTE: Numbers with letter designations represent parts included with primary numbered part for which there is no photo representation.

PARTS IDENTIFICATION GUIDE

SIGNATURE 310 2006 MODEL YEAR

Hull / Deck Exterior

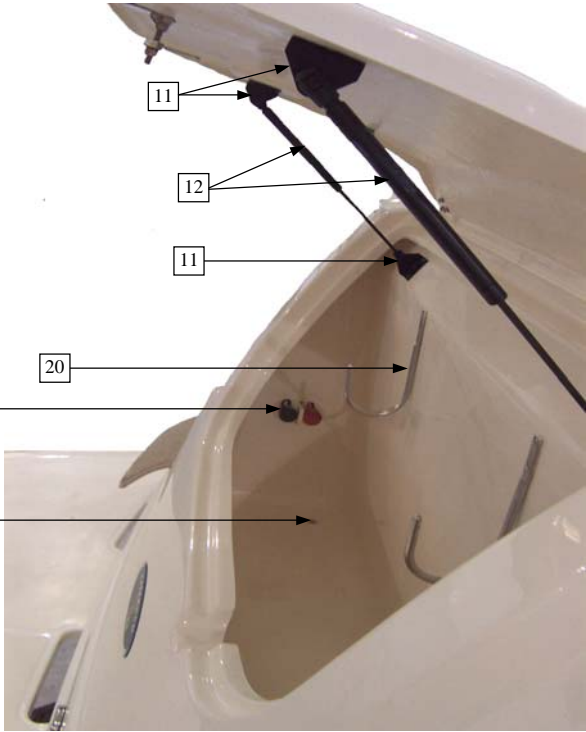
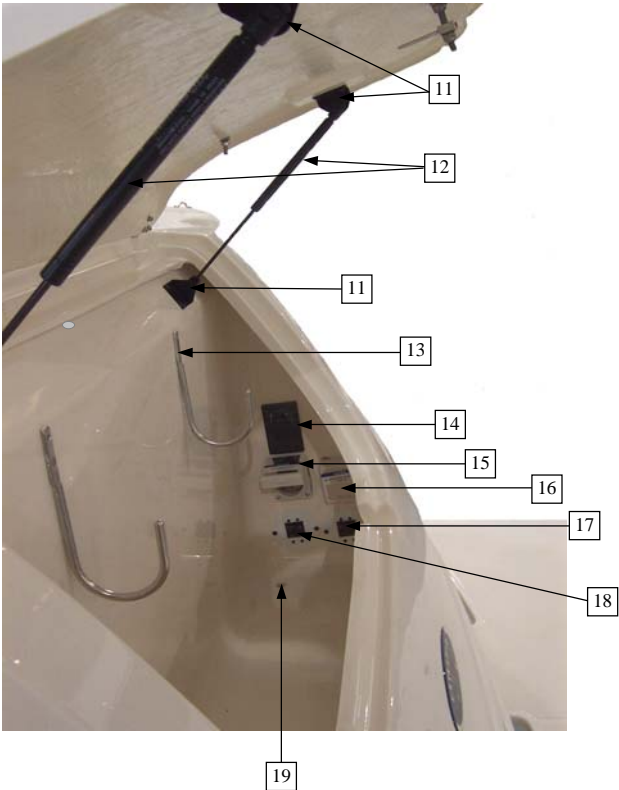
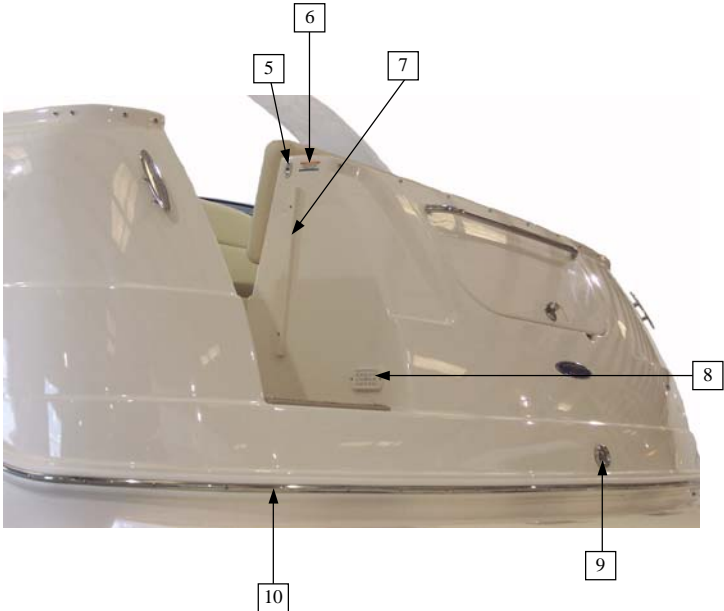
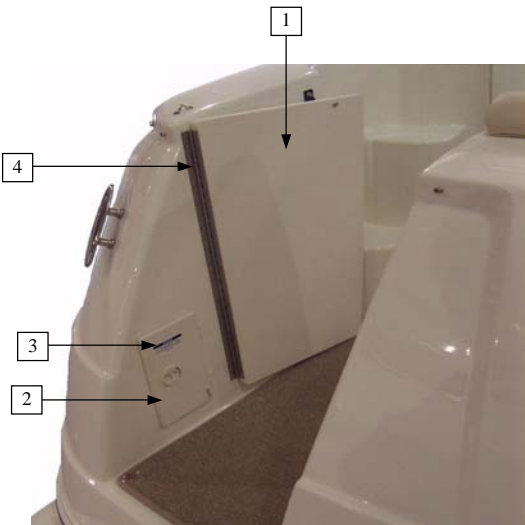

PARTS IDENTIFICATION GUIDE**SIGNATURE 310****2006 MODEL YEAR****Hull / Deck Exterior**

Item No.	Part Number	Description	Qty.	U.O.M.
1	IST34313	TRANSOM DOOR	1	EA
2	303SB7481	BONE TRANSOM SHOWER 3S SERIES	1	EA
3	U13777-01	NOTICE USING SHOWER LABEL	1	EA
4	CB12527-06SS	1.25 X 27 .066SS C'SUNK (Part of Door Assy)	1	EA
5	R-1227	STRIKER PLATE (200)	1	EA
6	U13767-01	WARNING OPEN DOORS MAY CAUSE DAMAGE	2	EA
7	IST34135	S300 TRANSOM DOOR STOP	1	EA
8	JBLREM35W	REMOTE - STEREO W/ DISPLAY	1	EA
8a	REXW-13	W-ADAPTOR -ALLOWS USE OF 2-3 STEREO REMOTES	1	EA
9	6356P1	TRANSOM LIGHT W/PACK.PLUG	1	EA
10	STA75160	SS 3/4 X.062 60IN RUBRAIL	1	EA
11	SL58SSP3-1	90 DEG. SS BRACKET	4	EA
12	625-SSID-6-20	GAS SHOCK SS 20LB	2	EA
13	R-1241	3/8 SS CABLE HOLDER (100) HOOK	1	EA
14	TV97	INLET	1	EA
14a	TV99	CORD	1	EA
15	HBL303NM	INLET PLUG (LOT 3)	1	EA
15a	U13779-01	NOTICE MAIN SHORE POWER LABEL	1	EA
16	HBL303NM	INLET PLUG (LOT 3) (Option: Air Conditioning)	1	EA
16a	U13775-01	NOTICE AIR CONDITIONER (Option: Air Conditioning)	1	EA
17	204-00040-A	AC SHORE INLET BRKR ASSY SIG (Option: Air Conditioning)	1	EA
17a	HBL61CM08W LED	50FT. CABLE 125V (LOT 3) (Option: Air Conditioning)	1	EA
17b	HBLCBINM	CIRCUIT BREAKER INLET COVER (Option: Air Conditioning)	1	EA
18	204-00040-A	AC SHORE INLET BRKR ASSY SIG	1	EA
18a	HBL61CM08W HBL61CM08WLED	50FT. CABLE 125V (LOT 3)	1	EA
18b	HBLCBINM	CIRCUIT BREAKER INLET COVER	1	EA
19	350	BUSHING SKI STORAGE	2	EA
21	JSC-2AW	JUMP START CHARGE ASSY.	1	EA
20	R-1241	3/8 SS CABLE HOLDER (100) HOOK (Option: Air Conditioning)	1	EA

Parts Not Pictured Which Are Associated With Hull / Deck Exterior:

Not Pictured	14-00125	DECAL - CO TRANSOM LABEL	1	EA
Not Pictured	1455	SS BARREL BOLT 4 1/2	1	EA
Not Pictured	CHA1315AR	TRIM TAB 13X15	1	EA
Not Pictured	203-00040-A	AIR COND SHORE PWR MAIN CABLE (Option: Air Conditioning)	1	EA
Not Pictured	HBL316NM	SHORE POWER INLET PLUG INTERNATIONAL (220V)	1	EA
Not Pictured	HBL316CSW	50FT WHITE CABLE 230V (220V)	1	EA
Not Pictured	U13810-01	SYMBOLE ELECTRICAL HAZARD CE (CE Pkgs)	1	EA

NOTE: Numbers with letter designations represent parts included with primary numbered part for which there is no photo representation.

PARTS IDENTIFICATION GUIDE

SIGNATURE 310
2006 MODEL YEAR

Graphics



PARTS IDENTIFICATION GUIDE**SIGNATURE 310****2006 MODEL YEAR****Graphics**

Item No.	Part Number	Description	Qty.	U.O.M.
1	14-00052	PLAQUE - CHROME OVAL 9X3.24- HULL BIRD LOGO	2	EA
1a	14-00096	DECAL - BIRD HEAD - HULL MET. SILVER 2.79X7.2	2	EA
2	QMI-215203	LARGE CHROME DESIGNATOR PLAQUE	4	EA
3	14-00131	DECAL - BIRD HEAD LOGO METALLIC SILVER	2	EA
4	U13675-02	SIGNATURE NAME	3	EA
5	14-00012	310 SIGNATURE DESIGNATOR	3	EA
6	QMI-215201	CHAPARRAL CHROME LETTERS	2	EA
7	14-00070	DECAL - PROTECTED DESIGN 2003	1	EA
8	U13656-02	EXTENDED V-HULL DECAL	1	EA
Not Pictured	14-00124	DECAL - WINDOW, WARRANTY	1	EA
Not Pictured	14-00051	LABEL- BOAT AND YACHT NMMA	1	EA

WHITE BOATS W/CHAMPAGNE INTERIOR

9	U16781-03A	GRAPHIC-SIGN. DECK STRIPE LT. GOLD/BLACK	63	FT
10	U16780-03A	GRAPHIC-SIGN. HULL STRIPE GOLD	70	FT
11	U16782-02A	GRAPHIC-SIGN. HULL GRAPHIC GOLD	1	SET

WHITE BOATS W/PLATINUM INTERIOR

9	U16781-02A	GRAPHIC-SIGN. DECK STRIPE BLACK/PEWTER	63	FT
10	U16780-02A	GRAPHIC-SIGN. HULL STRIPE MAGNESIUM BLACK	70	FT
11	U16782-01A	GRAPHIC-SIGN. HULL GRAPHIC PEWTER	1	SET

WIDE BAND GEL COAT W/GRAPHIC-BLACK/CHAMPAGNE

9	U16781-07A	GRAPHIC-SIGN. DECK STRIPE BLACK/OYSTER	63	FT
10	U19991-01A	GRAPHIC-SIGN. HULL STRIPE OYSTER	70	FT
11	U19990-01A	GRAPHIC-SIGN. HULL FLARE OYSTER	1	SET

WIDE BAND GEL COAT W/GRAPHIC-BLACK/PLATINUM

9	U16781-10A	GRAPHIC-SIGN. DECK STRIPE SILVER/BLACK	63	FT
10	U19991-02A	GRAPHIC-SIGN. HULL STRIPE SILVER 1.5 X 150	70	FT
11	U19990-02A	GRAPHIC-SIGN. WIDEBAND FLARE SILVER	1	SET

WIDE BAND GEL COAT W/GRAPHIC-BLUE/CHAMPAGNE

9	U16781-06A	GRAPHIC-SIGN. DECK STRIPE BLUE/OYSTER	63	FT
10	U19991-01A	GRAPHIC-SIGN. HULL STRIPE OYSTER	70	FT
11	U19990-01A	GRAPHIC-SIGN. HULL FLARE OYSTER	1	SET

WIDE BAND GEL COAT W/GRAPHIC-BLUE/PLATINUM

9	U16781-09A	GRAPHIC-SIGN. DECK STRIPE SILVER/BLUE 0.875 X 150	63	FT
10	U19991-02A	GRAPHIC-SIGN. HULL STRIPE SILVER 1.5 X 150	70	FT
11	U19990-02A	GRAPHIC-SIGN. WIDEBAND FLARE SILVER	1	SET

NOTE: Numbers with letter designations represent parts included with primary numbered part for which there is no photo representation.

PARTS IDENTIFICATION GUIDE
SIGNATURE 310
2006 MODEL YEAR

Dash / Helm

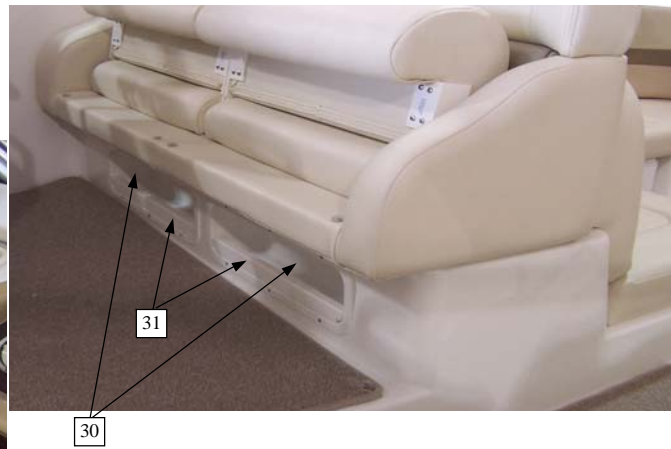
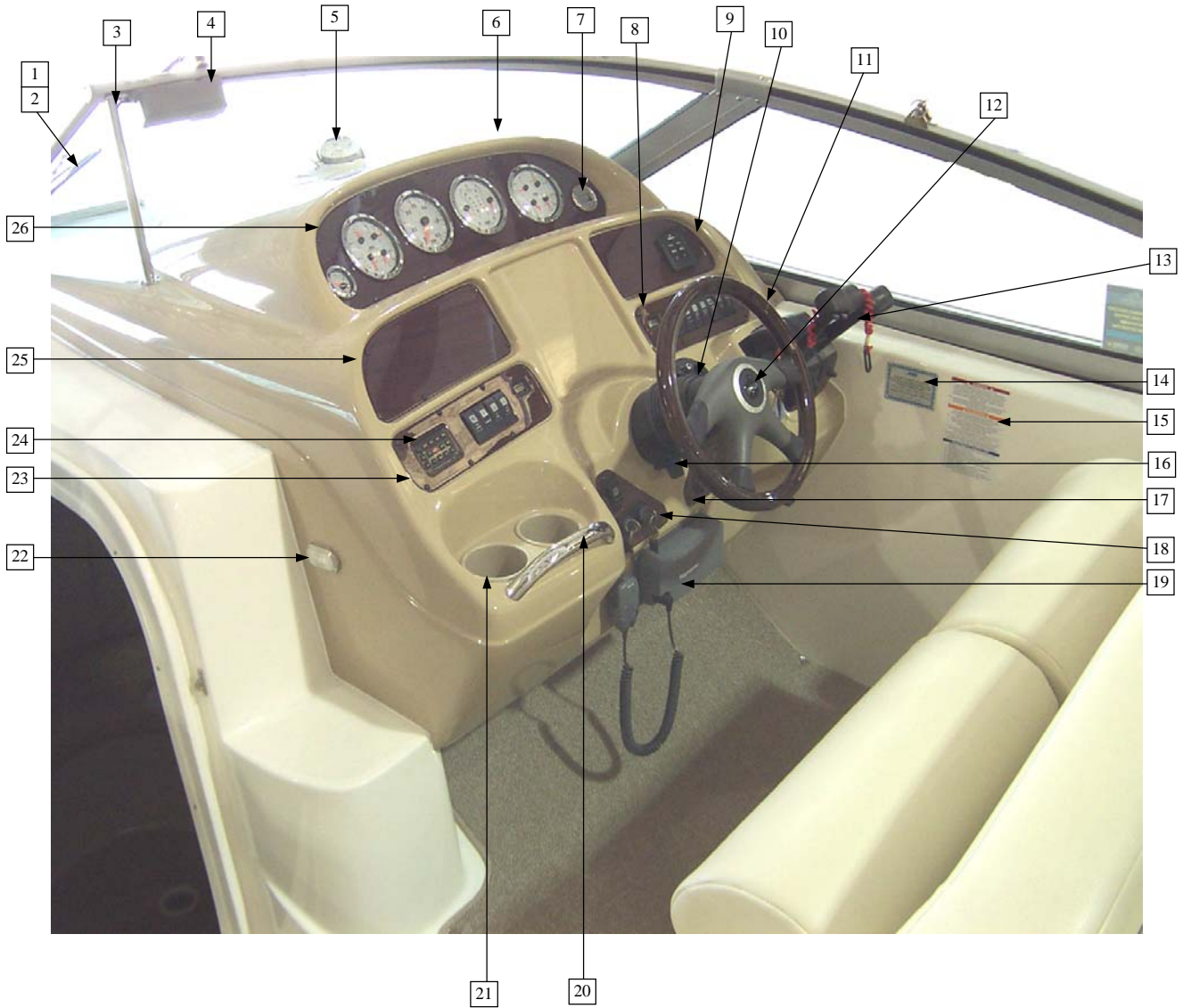

HELM SEAT BASE

PARTS IDENTIFICATION GUIDE**SIGNATURE 310****2006 MODEL YEAR****Dash / Helm**

Item No.	Part Number	Description	Qty.	U.O.M.
1	33110A	DLX WIPER ARM	1	EA
1a	120-0580	5/8 BLACK BILGE FLEX	0.16	FT
2	33105	14 INCH CURVED BLADE	1	EA
3	35289	WINDSHIELD - BRACE S310 - ADJUSTABLE	1	SET
4	37181R	WIPER MOTOR W/ REV. PARK 80 DEG.SWE	1	EA
5	HF-743W-C	HELMSMAN FLSH MNT COMPASS	1	EA
6	3-1250	310SIG STARBOARD CONSOLE (Champagne Interior)	1	EA
6a	3-1250G	310SIG STARBOARD CONSOLE GRAY (Platinum Interior)	1	EA
7	DS0141	DEPTH FINDER GAUGE	1	EA
7a	IS0091	DEPTH SOUNDER INSTRUCTION SHEET	1	EA
8	205-00237-A	STBD SWITCH PANEL S310	1	EA
9	205-00377-A	STBD UPPER CONSOLE PANEL W/TABS S310	1	EA
10	SH91523	QUICK CONNECT TILT HELM	1	EA
11	MS6073627CB	STEERING WHEEL - MAHOGANY	1	EA
12	14-00011	STEERING WHEEL DOME 1.42 INCHES	1	EA
13	3856903	TOP MOUNT TWIN W/TRIM (Volvo Engines)	1	EA
13a	883711A03 883711A04	GEN II DUAL BINN CONTROL (Mercuriser Engines)	1	EA
14	YACHTPLATE	YACHT PLATE	1	EA
14a	14-00023	310 SIG CE PLATE (CE Pkgs)	1	EA
14b	14-00035	S310 CONFORMITY PLATE (Canadian Boats Only)	1	EA
15	U17217-01	CO/OPERATOR/BOATMAN COMBO	1	EA
16	SH91510	SPLINE TILT MECHANISM	1	EA
17	205-00210-A	STBD STEERING PANEL S310/S330/S350	1	EA
18	205-00211-A	IGNITION PANEL S310/S330/S350 (Gasoline Engines)	1	EA
19	E43003	RAY 215 VHF RADIO	1	EA
19a	M46023	FLUSH MOUNT KIT/VHF215	1	EA
20	53109-1.5	9 IN RAIL	1	EA
21	12-00001	CUPHOLDER - STEPPED WELL 304SS W/ NOISE PROTECTION PAD	2	EA
22	80450SS-ML/A	OBLONG COURTESY LIGHT	1	EA
23	205-00374-A	PORT SWITCH PANEL ASSY S310	1	EA
24	JBLREM35B	REMOTE - STEREO W/ DISPLAY BLACK	1	EA
25	200-00307	PORT UPPER CONSOLE PANEL W/O GPS S310	1	EA
25a	200-00310	PANEL - PORT UPPER CONSOLE W/ ST60 (GPS Options)	1	EA
25b	A22013	ST60 TRIDATA (DIGITAL) SYSTEM (GPS Options)	1	EA
25c	D244	SEATALK JUNCTION BOX (GPS Options)	1	EA
25d	D284	SEATALK 1 METER CABLE (GPS Options)	2	EA
25e	E12102	PATHFINDER SMART HEADING SYSTEM (Option: Radar WAAS GPS)	1	EA
25f	IST34264	RADOME STBD WEDGE SHIM (Option: Radar WAAS GPS)	2	EA
25g	M92692	10 METER RADAR CABLE (Option: Radar WAAS GPS)	1	EA
25h	R58127	RADAR GLAN NUT (Option: Radar WAAS GPS)	1	EA
26	205-00235-A	INSTRUMENT PANEL S310	1	EA
27	310700	SLIDING DOOR 310SIG W/1" HANDLE	1	EA
27a	310701	SLIDING DOOR W/SCREEN 310SIG W/1 INCH HANDLE (Option: Sliding Door W/Screen)	1	EA
27b	935	CHROME WINDOW STOP	1	EA
27c	R-1826 /ISL12011	THRESHOLD - S310 SS DOOR TRIM 17.5IN	1	EA
28	3-1202	310SIG PORT CONSOLE	1	EA
29	300603	310SIG C/WAY TRIM	1	EA
30	49800220	FIRE EXTINGUISHER BOX	2	EA
31	IST34043	STORAGE BOX CLEAT	2	EA

Parts Not Pictured Which Are Associated With Dash / Helm :

Not Pictured	14-00127	DECAL - CO HELM LABEL	1	EA
Not Pictured	61710135251	STEERING WHEEL COVER	1	EA
Not Pictured	KS-22	DUAL I/O SAFETY SWITCH	1	EA
Not Pictured	SSC6217	17' STEERING CABLE	1	EA
Not Pictured	17-00013	LIGHT KIT & OWNERS MANUAL FOR DOMESTIC	1	EA
Not Pictured	17-00014	LIGHT KIT & OWNERS MAN. FOR INTERNATIONAL (CE Pkgs)	1	EA
Not Pictured	U13780-01	SAFETY ORANGE SYMBOL CE LABEL (CE Pkgs)	1	EA
Not Pictured	E32042	RAYSTAR 125LP WASS SEATALK (GPS Options)	1	EA
Not Pictured	E02011	E80 MULTIFUNCTION NAVIGATIONAL DISP (GPS Options)	1	EA
Not Pictured	E52010-S	RADOME 2KW - NO CABLE (Option: Radar WAAS GPS)	2	EA

NOTE: Numbers with letter designations represent parts included with primary numbered part for which there is no photo representation.

Not Pictured 205-00509-A

PANEL - IGNITION PORT DIESEL SIG (Diesel Engines)

1

EA

PARTS IDENTIFICATION GUIDE**SIGNATURE 310****2006 MODEL YEAR****Dash / Helm**

Part Number	Description	Qty.	U.O.M.
-------------	-------------	------	--------

MerCruiser Common Parts:

14-00069	DECAL - MERCURY IQ CERTIFICATION- CERTIFIED MANUFACTURER	1	EA
203-00174	HARNESS- TRIM PUMP 13'	1	EA
203-00175	HARNESS- TRIM PUMP 15'	1	EA
22-72932A3	MERC HEAT EXCHANGE KIT	1	EA
92020A2	TIE BAR DUAL ENG	1	EA
CC67919	TFXTREME GEN II MERC CABLE	1	EA
CC67922	TFXTREME GEN II MERC CABLE	1	EA

203-00530-A HARNESS - ALTERNATOR MERC 310SIG 1 EA

MerCruiser Gasoline Engines:

116-200-3340	3 3/4 MARINE EXHAUST HOSE	2.92	FT
132-0580R	5/8 HD WATER HEATER HOSE	2 @ 9.50	FT
151-0400	4MM PITOT TUBING	22	FT
360-0380	3/8 IN. FUEL LINE TYPE A1	5	FT
360-0380	3/8 IN. FUEL LINE TYPE A1	4.50	FT
864929A1	3IN RISER KIT	2	EA
CC67921	21FT MERC CONTROL CABLE	1	EA
CC67924	24FT MERC CONTROL CABLE	1	EA
EL3H3M	ELBOW 3/8 MPT X 3/8 HOSE BARB	2	EA

84-865772A)2 HARNESS-TRIM PUMP 2 EA

MerCruiser Diesel Engines:

116B04	1/4 FORGED BRASS ST ELBOW	2	EA
123-0120	1/2 FLAME RET.SPLIT COND.	38	FT
132-0580R	5/8 HD WATER HEATER HOSE	10.50	FT
132-0580R	5/8 HD WATER HEATER HOSE	8.25	FT
151-0400	4MM PITOT TUBING	24	FT
205-00325-A	PANEL - INSTRUMENT DIESEL	1	EA
2503-8-6	ELBOW - STEEL 90 DEGREE 3/8 FLARE X	4	EA
30682-6-6B	FITTING - BRASS STRAIGHT 3/8 FLARE	4	EA
31900	TANK - DIESEL 147 GALLON 310SIG	1	EA
360-0380	3/8 IN. FUEL LINE TYPE A1	2.66	FT
360-0380	3/8 IN. FUEL LINE TYPE A1	6.25	FT
360-0380	3/8 IN. FUEL LINE TYPE A1	3	FT
360-0380	3/8 IN. FUEL LINE TYPE A1	3.25	FT
360-0380	3/8 IN. FUEL LINE TYPE A1	6.42	FT
360-0380	3/8 IN. FUEL LINE TYPE A1	5	FT
500MA10	FUEL FILTER RACOR 10 MICRON	2	EA
540-SPL-005	DIESEL FUEL FILL	1	EA
863868A1	DIESEL TIE BAR	1	EA
CC67915	TFXTREME GEN II MERC CABLE	1	EA
CC67918	TFXTREME GEN II MERC CABLE	1	EA
DBN32	1/4X3/8 BRASS BARB HOSE	2	EA
LABEL-HOUSE	HOUSE BATTERY CABLE LABEL	2	EA

PARTS IDENTIFICATION GUIDE**SIGNATURE 310****2006 MODEL YEAR****Dash / Helm**

Part Number	Description	Qty.	U.O.M.
-------------	-------------	------	--------

Volvo Engines:

1163871	SPEEDO KIT W/O HOSE	1	EA
123-0120	1/2 FLAME RET.SPLIT COND.	5	FT
132-0580R	5/8 HD WATER HEATER HOSE	10	FT
132-0580R	5/8 HD WATER HEATER HOSE	7.25	FT
151-0400	4MM PITOT TUBING	24	FT
200-3120	3 1/2 SOFTWALL EXH. HOSE	2.92	FT
203-00318-A	WIRING - TRIM HARNESS 21FT. VOLVO	2	EA
2340-840	MIDGET VENT 1 1/2 X 1 3/4	1	EA
360-0380	3/8 IN. FUEL LINE TYPE A1	5.5	FT
360-0380	3/8 IN. FUEL LINE TYPE A1	5	FT
3850885 3841706	TIE BAR SX VOLVO	1	EA
3862097	3 INCH RISER KIT	2	EA
3862101	HEAT EXCHANGE KIT	1	EA
88334A2	MERCATHODE	2	EA
CC63321	21FT VOLVO EXTREME CABLE	1	EA
CC63322	22FT VOLVO EXTREME CABLE	1	EA
CC63324	24FT VOLVO EXTREME CABLE	1	EA
CC63326	26FT VOLVO EXTREME CABLE	1	EA
U13781-01	CAULK BEFORE INSTALLING LABEL	1	EA
203-00333-B	HARNESS DE CORROSION PROTECTION (5.7L GXI DP)	1	EA
203-00531-A	HARNESS - ALTERNATOR VOLVO 310SIG	1	EA

Volvo OSI Engines Only:

123-0120	1/2 FLAME RET.SPLIT COND.	2 @ 1.33	FT
123-0120	1/2 FLAME RET.SPLIT COND.	2 @ 20	FT
203-00162	HARNESS- NEUTRA SALT 5' EXTENSION	1	EA
205-00165	WIRING- PANEL NEUTRA SALT DE	1	EA
4-0124	ANGLE BRACKET 1X1X1/8-2IN	2	EA
IST12314	OSI ENGINES NEUTRA-SALT RESERVOIR B	2	EA

PARTS IDENTIFICATION GUIDE

SIGNATURE 310
2006 MODEL YEAR

Cockpit

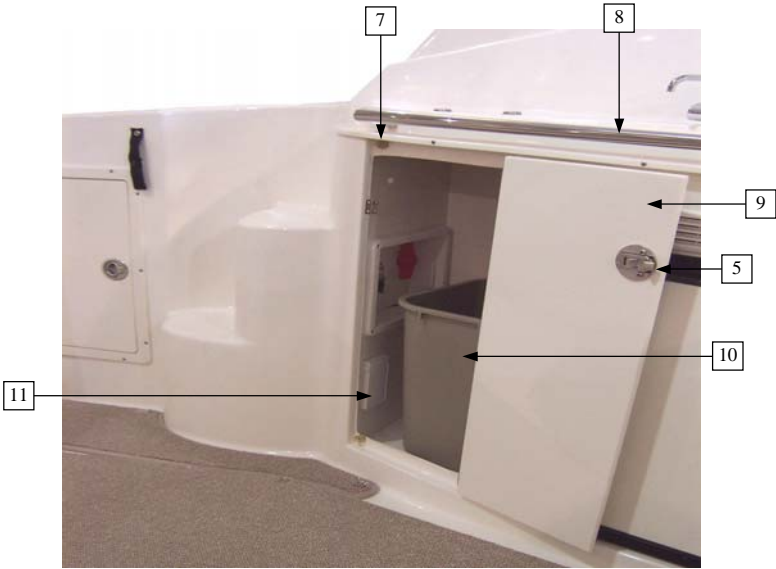

PARTS IDENTIFICATION GUIDE**SIGNATURE 310****2006 MODEL YEAR****Cockpit**

Item No.	Part Number	Description	Qty.	U.O.M.
1	12-00001	CUPHOLDER - STEPPED WELL 304SS W/ NOISE PROTECTION PAD	3	EA
2	53130-2	30" GRAB RAIL	1	EA
3	IST14256	S310 PORT CONSOLE COVER BOARD	1	EA
4	320502	320 GLOVE BOX/DRINK HLDR W/O LATCH	1	EA
5	M1-43-8	LATCH/LOCK SS (5000 MIN) 10 RELEASE	4	EA
6	IST12305	S310 GALLEY ICE BOX LID	1	EA
7	300604 / 28-00013	310SIG C-PIT GALLEY CAP	1	EA
8	35142	310S WET BAR RAIL	1	EA
9	300602	310SIG C-PIT GALLEY DOOR	1	EA
10	2952R	RUBBERMAID WASTE BASKET	1	EA
11	203-00119-A	12" OUT BOX - WHT GFCI WITH WHT W/P	1	EA
12	34-00001	FAUCET- FOLDOWN 3.5" SPOUT 1/2" NPS THREAD	1	EA
13	IST12304	S310 COCKPIT GALLEY TRASH CHUTE LID	1	EA
14	1425-1	WHITE FLUSH LOUVERED VENT (Option: Cockpit Refrigerator)	1	EA
15	37-00002	REFRIGERATOR-CRUISE65 AC/DC R-SWING (Option: Cockpit Refrigerator)	1	EA
15a	203-00120-A	12" OTBX WHT DEC W/WHT COVER REFR (Option: Cockpit Refrigerator)	1	EA
16	205-00376-A	PANEL - 310/350SIG BATTERY SWITCH	1	EA
17	100501	21 X 14 ACCESS DOOR	1	EA
18	556-SPL-003	WASTE FITTING W/RETAINER	1	EA

Parts Not Pictured Which Are Associated With Cockpit:

Not Pictured	01-00004	OWNERS INFO.BAG - 19X15 BLUE CHAPARRAL CANVAS	1	EA
Not Pictured	01-00007	OWNERS MANUAL - 06' 72PAGE	1	EA
Not Pictured	12-00002	CUPHOLDER - SHALLOW 304SS	4	EA
Not Pictured	300504	COCKPIT ACCESS DOOR (Std W/O Refrigerator)	1	EA
Not Pictured	81932-C	3IN. GRILL CURVED CHROME (Inside Cockpit Galley)	1	EA
Not Pictured	APD-290F	90 DEG. WHITE FLAT DRAIN	2	EA
Not Pictured	DP40-38	1998 4 IN. WHT DECK PLATE (Inside Cockpit Galley)	1	EA
Not Pictured	H-128	16 INCH GRAB HANDLE	1	EA
Not Pictured	KCC900-956	OWNERS MANUAL - INTERNATIONAL MULTI LANGUAGE (CE Pkgs)	1	EA
Not Pictured	MS-6100BW	SPEAKER - 6IN DUAL CONE 105 WATT, WHITE JBL	2	EA
Not Pictured	MS-6200	SPEAKER - 6IN COAXIAL WHITE, 180 WATT JBL (Option: Speaker Upgrade)	2	EA
Not Pictured	PP-118	PUSH PLUG - VINYL	1	EA
Not Pictured	T34	3/4 X 3/4 X 3/4 NYLON TEE	1	EA

NOTE: Numbers with letter designations represent parts included with primary numbered part for which there is no photo representation.

PARTS IDENTIFICATION GUIDE

SIGNATURE 310
2006 MODEL YEAR

Cockpit

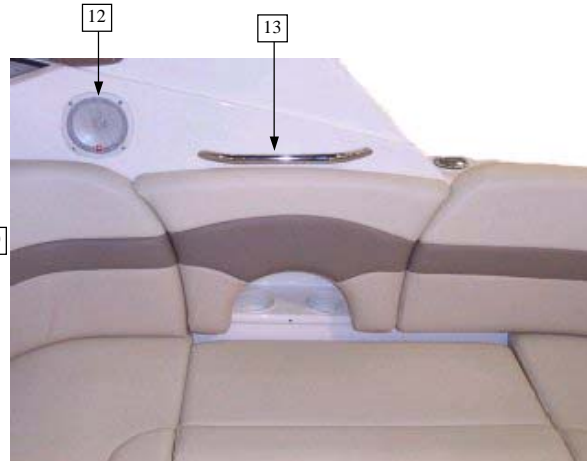
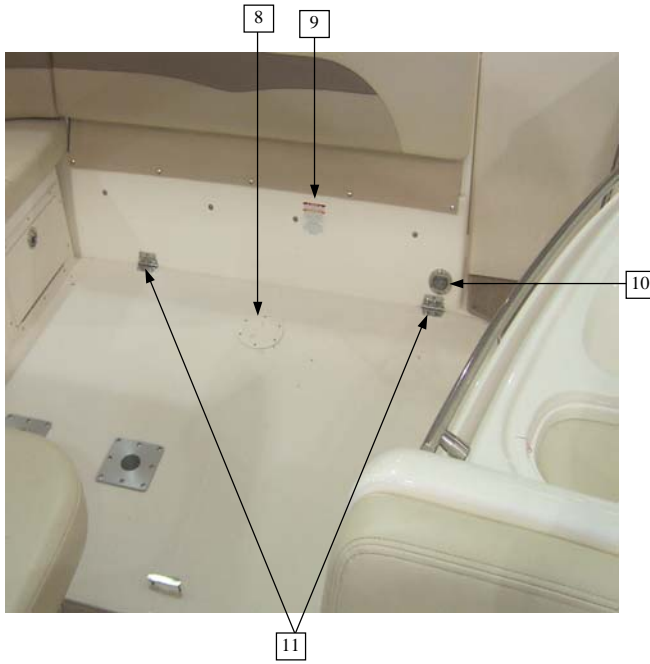
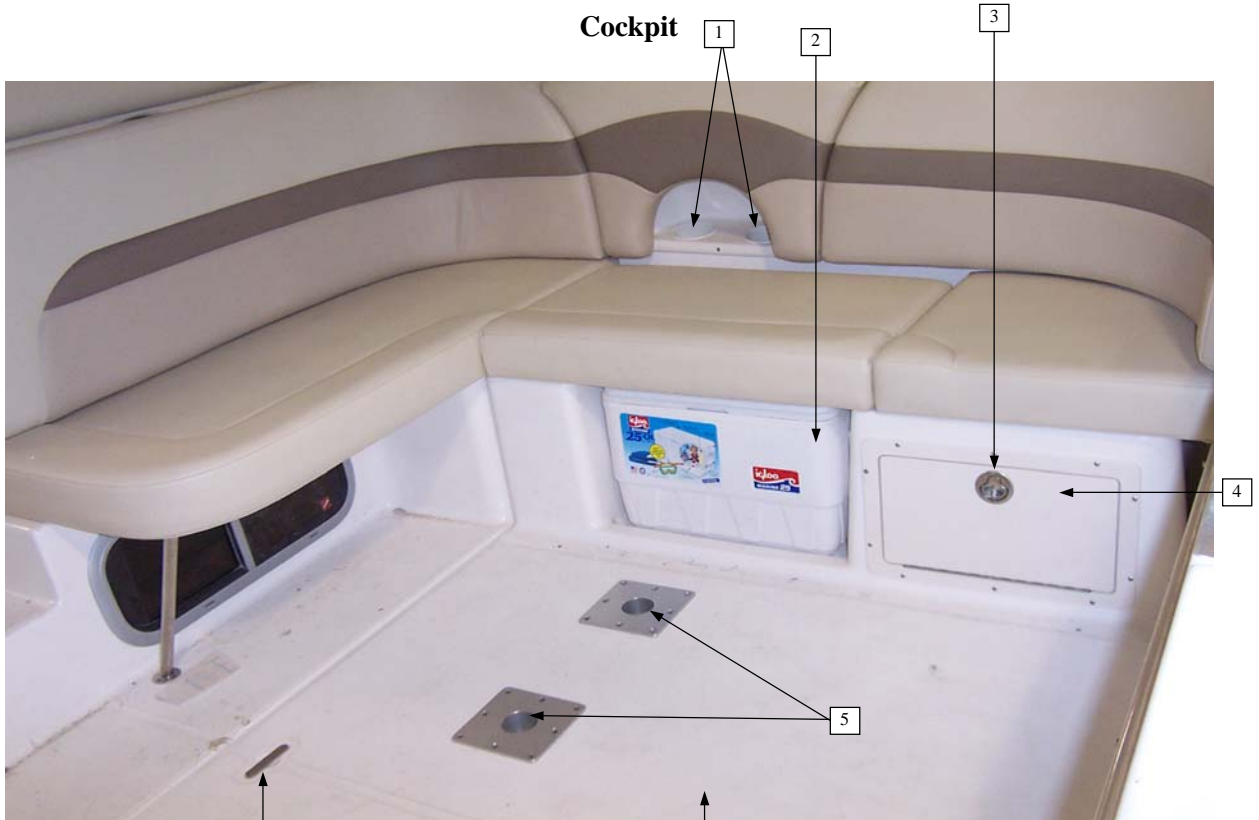

PARTS IDENTIFICATION GUIDE**SIGNATURE 310**
2006 MODEL YEAR**Cockpit**

Item No.	Part Number	Description	Qty.	U.O.M.
1	12-00001	CUPHOLDER - STEPPED WELL 304SS W/ NOISE PROTECTION PAD	3	EA
2	I6776	25QT MARINE COOLER	1	EA
3	M1-43-8	LATCH/LOCK SS (5000 MIN)	1	EA
4	186501	11 X 17 1/2 ACCESS DOOR	1	EA
5	75355	TABLE BASE 9 1/4	1	EA
5a	3381-2403	HOLE PLUG	1	EA
6	3-1204	310SIG LARGE MOTOR LID	1	EA
6a	3-1203	310SIG SMALL MOTOR LID	1	EA
7	16-323-00000	STAINLESS STEEL HANDLE	1	EA
8	DP40-38	1998 4 IN. WHT DECK PLATE	1	EA
9	U17218-01	IN CASE OF FIRE/SECURE ENGINE LIDS	1	EA
10	6356P1	TRANSOM LIGHT W/PACK.PLUG	1	EA
11	1654	HINGE 3 IN. X 3IN.	2	EA
12	MS-6100BW	SPEAKER - 6IN DUAL CONE 105 WATT, WHITE JBL	2	EA
12a	MS-6200	SPEAKER - 6IN COAXIAL WHITE, 180 WATT JBL (Option: Speaker Upgrade)	2	EA
13	H-045	17 INCH OVAL GRABRAIL	1	EA

Parts Not Pictured Which Are Associated With Cockpit:

Not Pictured	4-1081	S310 ENGINE LID CHANNEL	1	EA
Not Pictured	4-1080	S310 COCKPIT TABLE	1	EA
Not Pictured	75356	FLOOR BASE 9 1/4	1	EA
Not Pictured	75357-65	TABLE LEG - 28 5/8 X 9.25 ALUMINUM	1	EA
Not Pictured	75357-67	TABLE LEG - 14 3/8 X 9.25 ALUMINUM	1	EA
Not Pictured	35250	320S SEAT BRACE	1	EA
Not Pictured	100W1X1/4	WHITE TEXTURE TRIM	8	FT

NOTE: Numbers with letter designations represent parts included with primary numbered part for which there is no photo representation.

PARTS IDENTIFICATION GUIDE

SIGNATURE 310 2006 MODEL YEAR

Forward Cabin



PARTS IDENTIFICATION GUIDE

Go Back

SIGNATURE 310 **2006 MODEL YEAR**

Forward Cabin

Item No.	Part Number	Description	Qty.	U.O.M.
1	8268-14-B.AM	HALOGEN LIGHT W/ AMP BULLET CONNECT	2	EA
2	81292-NIX-ML/A	BRUSHED SURFACE MOUNT LIGHT	9	EA
3	DVDME-2	DVD PLAYER - BLAUPUNKT	1	EA
3a	35268	BRACKET - DVD - SS PLATE	1	EA
3b	201-00042	FACEPLATE - DVD SHIM	1	EA
4	45-00005	TABLE - S310 DINNETTE TABLE	1	EA
4a	75354	TABLE BASE	1	EA
5	75359-83	27 1/2 LEGS	1	EA
5a	75359-74	13 1/4 LEGS	1	EA
5b	IST12331	SMALL TABLE BASE CLIP	6	EA
5c	IST12330	LARGE TABLE BASE CLIP	4	EA
6	203-00470-A	GRAY DECORA ASSY 2 12" PIGS	3	EA
7	217000507	10 X 5TH MF PNTD BLACK (Part of Air Conditioning Kit)	1	EA
8	205-00434-A	PANEL 280/290 SIG GAS GENERATOR (Option: Generator)	1	EA
9	CMD-4M-BPA-C	CO DETECTOR - BACK PANEL WITH MOLEX CONNECTOR	1	EA
9a	CMD-4M-FCB	CO DETECTOR - FRONT COVER AND CIRCUIT BOARD	1	EA
9b	14-00126	DECAL - CO CABIN LABEL	1	EA

Parts Not Pictured Which Are Associated With Forward Cabin:

Not Pictured	SFT012-TC-42-MLX/A	42" SOFT TOUCH LIGHT (Behind Port V-Berth Backrest)	1	EA
Not Pictured	SFT012-TC-48-MLX/A	48" SOFT TOUCH LIGHT (Behind Stbd V-Berth Backrest)	1	EA
Not Pictured	GROUPER	FISH ANODE	1	EA

NOTE: Numbers with letter designations represent parts included with primary numbered part for which there is no photo representation.

PARTS IDENTIFICATION GUIDE

SIGNATURE 310
2006 MODEL YEAR

Forward Cabin



PARTS IDENTIFICATION GUIDE

SIGNATURE 310 **2006 MODEL YEAR**

Forward Cabin

Item No.	Part Number	Description	Qty.	U.O.M.
1	200-00028	STEREO FACEPLATE	1	EA
1a	MR-17S	STEREO - CD PLAYER, SIRIUS READY	1	EA
1b	SEA-ANT	AM/FM ANTENNA	1	EA
1c	SEA-STRAP	8IN. SUPPORT STRAP	1	EA
1d	JBSIR2.5	SIRIUS - TUNER BOX	1	EA
1e	SRA-30G	ANTENNA - SIRIUS SATELLITE	1	EA
2	75375-40	FLOOR BASE	1	EA
3	625-SSID-8-40	GAS SHOCK SS 40LB 20 INCH	2	EA
4	SL58SSP3-1	90 DEG. SS BRACKET	4	EA

Parts Not Pictured Which Are Associated With Forward Cabin:

Not Pictured	12-00001	CUPHOLDER - STEPPED WELL 304SS W/ N	4	EA
Not Pictured	203-00046-A	12" OUT BOX - WHT DECORA W/ WATER PROOF CVR	1	EA
Not Pictured	24-7130	CABLE - 6FT RCA AUDIO	1	EA
Not Pictured	24-7145	CABLE - 25FT RCA AUDIO	1	EA
Not Pictured	27-230	COUPLER - VIDEO CABLE	1	EA
Not Pictured	24-7125	CABLE - 3FT RCA AUDIO (Option: Subwoofer)	1	EA
Not Pictured	BASSLINK	SUBWOOFER - 10IN. INFINITY SELF-POWERED (Option: Subwoofer)	1	EA
Not Pictured	24-7145	CABLE - 25FT RCA AUDIO (Option: Speaker Upgrade W/Amp)	2	EA
Not Pictured	GTO75.4	AMPLIFIER - 4 X 75 WATT (Option: Speaker Upgrade W/Amp)	1	EA
Not Pictured	203-00460-A B	HARNESS 310 SIG OPT POWER AMP (Option: Speaker Upgrade W/Amp)	1	EA

NOTE: Numbers with letter designations represent parts included with primary numbered part for which there is no photo representation.

PARTS IDENTIFICATION GUIDE

SIGNATURE 310
2006 MODEL YEAR

Aft Cabin



INSIDE AFT CABIN FACING AFT



INSIDE AFT CABIN FACING INBOARD



AFT END OF FWD CABIN FLOOR



COMPANION WAY FACING AFT

PARTS IDENTIFICATION GUIDE**SIGNATURE 310****2006 MODEL YEAR****Aft Cabin**

Item No.	Part Number	Description	Qty.	U.O.M.
1	5901092242-A	9X24 SLIDE WINDOW	1	EA
1a	U16817-01	WINDOW WARNING LABEL	1	EA
2	3-1208 IST34300	310S SIG HELM STORAGE KEEPER UB	1	EA
3	45-00011	TABLE - S350/S310 AFT TABLE (Option: Aft Cabin Table)	1	EA
3a	75354	TABLE BASE (Option: Aft Cabin Table)	1	EA
3b	300336TC	S350/S310 AFT CABIN TABLE COVER (Option: Aft Cabin Table)	1	EA
3c	IST12331	SMALL TABLE BASE CLIP (Option: Aft Cabin Table)	2	EA
4	75359-85	25 1/2 LEGS (Option: Aft Cabin Table)	1	EA
4a	75375-40	FLOOR BASE (Option: Aft Cabin Table)	1	EA
5	IST34003SDP	PORT AFT BERTH FILLER BAR HOLDER	1	EA
6	IST34003SDS	STARBOARD AFT BERTH FILLER BAR HOLDER	1	EA
7	3-1219	310SIG STB AFT CAB STG TUB	1	EA
8	81292-NIX-ML/A	BRUSHED SURFACE MOUNT LIGHT	5	EA
9	IST34300 3-1208	S310 AFT CABIN STORAGE TUB (P6R Side)	1	EA
10	IST34002SD	S310 AFT BERTH FLOOR HATCH	1	EA
11	IST34001SD	S310 GALLEY FLOOR HATCH	1	EA
12	310701	SLIDING DOOR W/SCREEN 310SIG W/1 INCH HANDLE (Opt: Door W/Screen)	1	EA
12a	310700	SLIDING DOOR 310SIG W/1" HANDLE	1	EA
13	35248	S310 COMPANIONWAY LADDER	1	EA
14	45-00006	STEPS - S310 3PC STEP SET	1	SET
14a	14-00018	310S STEP NON-SKID/TOP 4PC SET	1	SET
14b	14-00017	310S STEP NON-SKID/MIDDLE 4 PC. SET	1	SET
14c	14-00019	310S STEP NON-SKID/BOTTOM 4 PC SET	1	SET
15	35287	S310 STB CABIN ENTRY RAIL	1	EA
16	ACN-6150	TV - AXION 15 INCH LCD TV/DVD COMBO (Option: Aft Cabin TV)	1	EA
16a	15-00005	15" RCA TV WIRING (Option: Aft Cabin TV)	1	EA
16b	170-00005-57	CABLE 1' AUDIO VIDEO EXTENSION (Option: Aft Cabin TV)	1	EA
16c	203-00223-A	60" & 12" OTBX DECOR W/BLK CVR (Option: Aft Cabin TV)	1	EA
16d	203-00472-A	OUTLET 12IN GRA DECORA W/ SHALLOW BOX (Option: Aft Cabin TV)	1	EA
16e	700-8440140	SWITCH STAINLESS STEEL DECORATIVE COVER (Option: Aft Cabin TV)	1	EA
16f	CHRG40MM	40 FT COAX MALE X MALE (Option: Aft Cabin TV & Int'l/CE Pkgs)	1	EA
16g	CHRG48MM	48 INCH COAX MALE X MALE (Option: Aft Cabin TV & Int'l/CE Pkgs)	1	EA
16h	TX343002	2 WAY SIGNAL SPLITTER (Option: Aft Cabin TV & Int'l/CE Pkgs)	1	EA

Parts Not Pictured Which Are Associated With Aft Cabin:

Not Pictured	MCDC-100	JBL 6 DISC CHANGER (Option: JBL CD 6 Disc Changer)	1	EA
--------------	----------	--	---	----

NOTE: Numbers with letter designations represent parts included with primary numbered part for which there is no photo representation.

PARTS IDENTIFICATION GUIDE

SIGNATURE 310
2006 MODEL YEAR

Galley

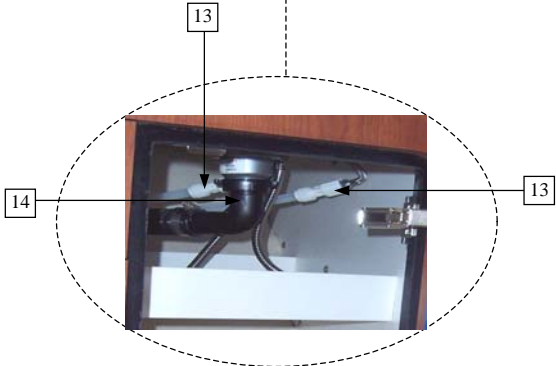

PARTS IDENTIFICATION GUIDE**SIGNATURE 310****2006 MODEL YEAR****Galley**

Item No.	Part Number	Description	Qty.	U.O.M.
1	203-00475-A	OUTLET BOX 58IN & 40IN GRA GFCI (DB)	1	EA
2	588-1060004	PLEXIGLASS - SLIDING DOOR ASSEMBLY	1	EA
3	204-00042-A	SWITCH 310 SIG SW ASSEMBLY GRY SHALLOW	1	EA
4	LC15S4U LC15S4US	TV-15" SHARP LCD W/ BOTTOM SPEAKERS	1	EA
4a	15-00007	15" SHARP TV WIRING	1	EA
4b	24-4586	25FT RCA CABLES GOLD PLATED ENDS	1	EA
4c	LC33-480	DOUBLE MALE CONNECTOR	1	EA
4d	QM100-F	FLAT FIXED LCD TV MOUNT	1	EA
4e	RS151247	MINI TV A/B SWITCH	1	EA
4f	U22354-01	DECAL - TV WARNING LABEL	1	EA
5	97655CP	PORTOFINE DUAL FAUCET	1	EA
5a	141-1120	1 1/2 IN MULTIFLEX-BLACK	5	FT
6	10244	S300 S/S SINK	1	EA
6a	10313	DRAIN W/BASKET STRAINER	1	EA
7	53118-2	18 IN. OVAL GRAB RAIL	1	EA
8	37-00003	REFRIGERATOR- CRUISE130 AC/DC L-SWING	1	EA
9	B40515	MED. 2BURNER TRIMLINE 110	1	EA
9a	B40516	MED 2BURNER TRIMLINE 220V (220V)	1	EA
10	B92008	SEA RAIL KIT	1	EA
11	220-03906-P	S270 WATER PRESS/PWR PLUG	1	EA
12	15-00002	MICROWAVE - SILVER/STAINLESS STEEL	1	EA
12a	15-00003	MICROWAVE - SILVER/STAINLESS STEEL 220V (220V)	1	EA
13	F06873	1/2P X 1/2FPT STR SWVL BS	2	EA
14	655010XFBB	BLK 8 WASTE ARM HL W/FIB	1	EA

Parts Not Pictured Which Are Associated With Galley:

Not Pictured	205-00023-A	GALLEY CIRCUIT BREAKER PANEL S310	1	EA
Not Pictured	15-00004	COFFEE MAKER- 4- CUP DRIP BLK/SS POT	1	EA
Not Pictured	205-00022-F	WIRING - 120V AC PANEL 310SIG	1	EA
Not Pictured	2530P-B	GALVANIC ISOLATOR- 30AMP	1	EA
Not Pictured	2956R	BEIGE WASTEBASKET	1	EA
Not Pictured	4-1089	S310 GALLEY FLOOR	1	EA
Not Pictured	CHRG14M	14IN. COAX CABLE W/HDWR	1	EA
Not Pictured	CHRG25MF	25 FEET COAXIAL W/F MALE-FEMALE	1	EA
Not Pictured	CHRG40MM	40 FT COAX MALE X MALE	1	EA
Not Pictured	SFT012-TC-48-MLX/A	48" SOFT TOUCH LIGHT (Underneath Cabinet)	1	EA
Not Pictured	U13761-01	MARPOL TREATY LABEL	1	EA
Not Pictured	U17402-01	WARNING UNSECURED ITEMS	1	EA

NOTE: Numbers with letter designations represent parts included with primary numbered part for which there is no photo representation.

PARTS IDENTIFICATION GUIDE

SIGNATURE 310
2006 MODEL YEAR

Head

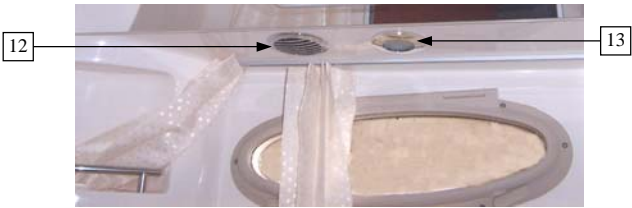
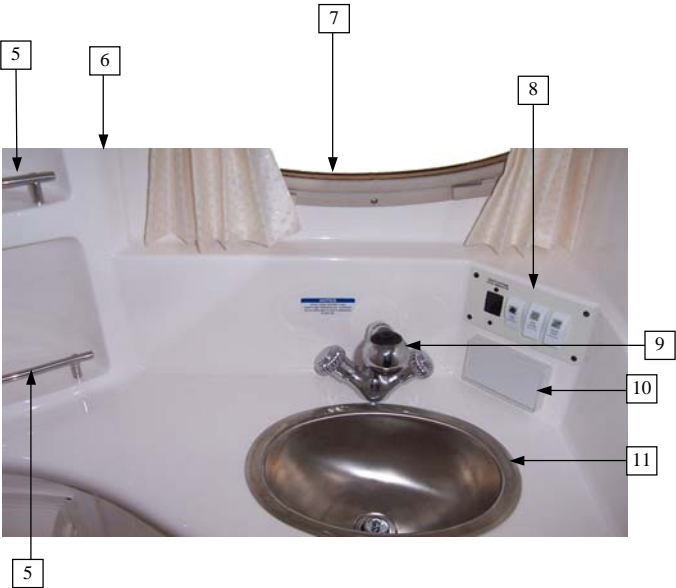

UNDERNEATH MEDICINE CABINET

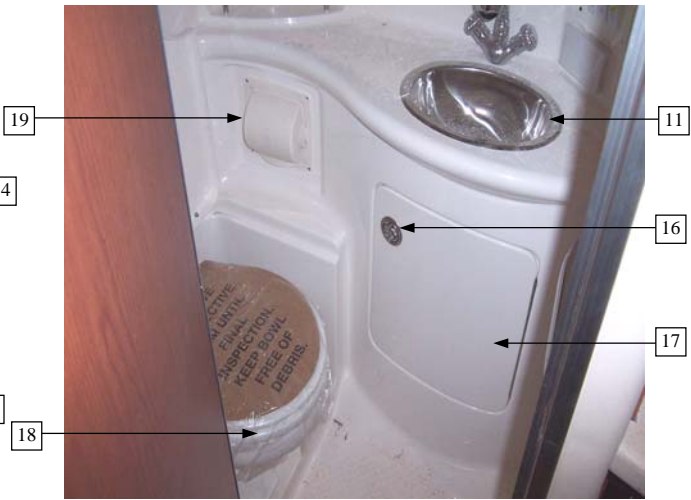

PARTS IDENTIFICATION GUIDE**SIGNATURE 310****2006 MODEL YEAR****Head**

Item No.	Part Number	Description	Qty.	U.O.M.
1	6424	S300 HEAD DOOR RING	1	EA
2	U13767-01	WARNING OPEN DOORS MAY CAUSE DAMAGE	1	EA
3	85411	LEFT HAND OUT HEAD DOOR LOCK	1	EA
4	35239	310S PORT COMPANIONWAY RAIL 28 INCH	1	EA
5	35236	310S HEAD KEEPER RAIL	1	SET
6	3-1211	310SIG HEAD	1	EA
7	JB518SSCH138	5 X 18 PORT LIGHT 1 3/8 SPIGOT	1	EA
8	205-00332-A	PANEL SIGN HEAD	1	EA
9	97655CP	PORTOFINE DUAL FAUCET	1	EA
10	203-00046-A	12" OUT BOX - WHT DECORA W/ WATER P	1	EA
11	41-00005	SINK - 13 X 10 STAINLESS STEEL SATIN	1	EA
11a	65SPR1303	1-1/4 X 5 LAV. DRAIN	1	EA
12	81932-C	3IN. GRILL CURVED CHROME	1	EA
13	81290-NIX-ML/A	BRUSHED RECESSED LIGHT	2	EA
14	3-1205	310SIG TOILET SEAT LID	1	EA
14a	CB12519-06SS	1.25 X 19.06 SS 4IN CTR (Hinge)	1	EA
14b	IST34111	SIDE ENTRANCE DOOR CLEAT	1	EA
15	33RP-127-G	1 1/2 IN. SHOWER STRAINER	1	EA
15a	34B1057R	1-1/2 RUBBER FLAT GASKET	1	EA
15b	35B553	1 1/2 SLIP NUT-METAL	1	EA
15c	74RF839901	5/8 STRAINER 90 DEGREE	1	EA
16	M1-63-8	LATCH/FLUSH SS(5000 MIN) 10 RELEASE	1	EA
17	310600	310SIG HEAD DOOR	1	EA
18	317014701	147 WHITE TOILET	1	EA
18a	U13774-01	NOTICE DO NOT DISPOSE CHL	1	EA
18b	C1/2X100PEX	1/2 IN. PEX COLD COIL 100 FT.	2	FT
19	DR-CB-OEM	DRYROLL TISSUE HOLDER	1	EA

Parts Not Pictured Which Are Associated With Head:

Not Pictured	1733P1	3 INCH BLOWER W/ PACKARD PLUG	1	EA
Not Pictured	402-3000	3 IN. BLOWER/VENT HOSE-BLK	4	FT
Not Pictured	CB-4W	4.5IN WHITE MTR WELL BOOT	2	EA
Not Pictured	430X375WHITE	430 X 375 WHITE CAP	2	EA
Not Pictured	35231	RAIL- FWD MOTOR BOX LID 220SSI (Head Wall Grab Rail)	1	EA
Not Pictured	U17220-01	NOTICE BEFORE DUMPING MACERATOR	1	EA
Not Pictured	1178-KTS	KHAKI TOWEL SET (Option: Accessory Packages)	2	SET

NOTE: Numbers with letter designations represent parts included with primary numbered part for which there is no photo representation.

PARTS IDENTIFICATION GUIDE

SIGNATURE 310
2006 MODEL YEAR

Air Conditioning / 110V



PARTS IDENTIFICATION GUIDE**SIGNATURE 310****2006 MODEL YEAR****Air Conditioning / 110V**

Item No.	Part Number	Description	Qty.	U.O.M.
1	217700242	11X13ALM FLAT PNTD CAMEO	1	EA
2	CHA310-04	AIR CONDITIONER 110 VOLT 12,000 BTU 310SIG	1	EA
2a	205311503	VCD12K/1-LH LEFT HAND I/O CONTROL 1	1	EA
2b	335441	BEZEL POLY BACK 4.84X3.23	1	EA
2c	229500529	BOX ABS V105X5.75/B3.E6OB-DIV60/40-	1	EA
2d	226600015	DUCT INS FLEX 6IN	6	FT
2e	226600045	DUCT INS FLEX 3IN	3	FT
2f	226000006	HOSE W/WATER 5/8 IN WHITE	25	FT
2g	225500205	PUMP PML500 115V 3/4NYLON	1	EA
2h	228701015	RG ABS DCT 6"MR 9/12K	1	EA
2i	335883	RING MOUNT 6"	1	EA
3	217000507	10X5TH MF PNTD BLACK	1	EA
4	333437	GRILL EURO ROUND 3IN BLAC	1	EA
5	222000210	DISPLAY ELITE I/O PASSPOR	1	EA
5a	205-00022	S310 AC PANEL	1	EA
5b	U17407-01	WHEN USE A/C SUMP BRKR ON	1	EA

Parts Not Pictured Which Are Associated With Air Conditioning:

Not Pictured	100-0340	3/4 HARDWALL WATER HOSE	1	FT
Not Pictured	100-0340	3/4 HARDWALL WATER HOSE	2	FT
Not Pictured	203-00050-A	AIR COND PUMP CABLE 310SIG	1	EA
Not Pictured	2530P-B	GALVANIC ISOLATOR- 30AMP	1	EA
Not Pictured	301-4A	5/8 IN. PLASTIC THRU-HULL	1	EA
Not Pictured	493-5	3/4 WATER STRAINER (1990)	1	EA
Not Pictured	65-007-51	3/4 PIPE HOSE ADAPTER	1	EA
Not Pictured	700-HADUBOX	BLUE RECEIPT BOX	1	EA
Not Pictured	700-TP13W	BLANK OUTLET COVER	1	EA
Not Pictured	78-115-01	3/4 BRONZE SEA FLANGE	1	EA
Not Pictured	906061	SCOOP SCREEN	1	EA
Not Pictured	DBN66	3/4MPT 3/4HBB BRS CPL	2	EA
Not Pictured	L567205	3/4 BRONZE THRU HULL	1	EA
Not Pictured	U13815-01	RAW WATER INLET/AIR CONDITIONER LABEL	8	EA

NOTE: Numbers with letter designations represent parts included with primary numbered part for which there is no photo representation.

PARTS IDENTIFICATION GUIDE

SIGNATURE 310
2006 MODEL YEAR

Air Conditioning / 220V



PARTS IDENTIFICATION GUIDE**SIGNATURE 310****2006 MODEL YEAR****Air Conditioning / 220V**

Item No.	Part Number	Description	Qty.	U.O.M.
1	217700242	11X13ALM FLAT PNTD CAMEO	1	EA
2	CHA310-04Z	AIR CONDITIONER 310 SIG 12,000 BTU 220VOLT	1	EA
2a	205411651	VCD12KZ50/1-LH 417A LEFT HAND	1	EA
2b	335441	BEZEL POLY BACK 4.84X3.23	1	EA
2c	229500529	BOX ABS V105X5.75/B3.E6OB-DIV60/40-	1	EA
2d	226600015	DUCT INS FLEX 6IN	6	FT
2e	226600045	DUCT INS FLEX 3IN	2	FT
2f	226000006	HOSE W/WATER 5/8 IN WHITE	25	FT
2g	225500204	PUMP PML500 220/50 3/4NYL	1	EA
2h	228701015	RG ABS DCT 6"MR 9/12K	1	EA
2i	335883	RING MOUNT 6"	1	EA
3	217000507	10X5TH MF PNTD BLACK	1	EA
4	333437	GRILL EURO ROUND 3IN BLAC	1	EA
5	222000210	DISPLAY ELITE I/O PASSPOR	1	EA
5a	205-00022	S310 AC PANEL	1	EA
5b	U17407-01	WHEN USE A/C SUMP BRKR ON	1	EA

Parts Not Pictured Which Are Associated With Air Conditioning:

Not Pictured	100-0340	3/4 HARDWALL WATER HOSE	1	FT
Not Pictured	100-0340	3/4 HARDWALL WATER HOSE	2	FT
Not Pictured	203-00040-A	AIR COND SHORE PWR MAIN CABLE	1	EA
Not Pictured	203-00050-A	AIR COND PUMP CABLE 310SIG	1	EA
Not Pictured	204-00040-A	AC SHORE INLET BRKR ASSY SIG	1	EA
Not Pictured	2530P-B	GALVANIC ISOLATOR- 30AMP	1	EA
Not Pictured	301-4A	5/8 IN. PLASTIC THRU-HULL	1	EA
Not Pictured	493-5	3/4 WATER STRAINER (1990)	1	EA
Not Pictured	65-007-51	3/4 PIPE HOSE ADAPTER	1	EA
Not Pictured	700-HADUBOX	BLUE RECEIPT BOX	1	EA
Not Pictured	700-TP13W	BLANK OUTLET COVER	1	EA
Not Pictured	71001	5/8IN(1/2IN) SS THRU HULL BARB	1	EA
Not Pictured	78-115-01	3/4 BRONZE SEA FLANGE	1	EA
Not Pictured	906061	SCOOP SCREEN	1	EA
Not Pictured	DBN66	3/4MPT 3/4HBB BRS CPL	2	EA
Not Pictured	HBL316CSW	50 FT. WHITE CABLE 230V	1	EA
Not Pictured	HBL316NM	SHORE POWER INLET PLUG INTERNATIONA	1	EA
Not Pictured	HBLCBINM	CIRCUIT BREAKER INLET COVER	1	EA
Not Pictured	L567205	3/4 BRONZE THRU HULL	1	EA
Not Pictured	R-1241	3/8 SS CABLE HOLDER (100) HOOK	1	EA
Not Pictured	U13775-01	NOTICE AIR CONDITIONER SHORE POWER	1	EA
Not Pictured	U13775-01	NOTICE AIR CONDITIONER SHORE POWER	1	EA
Not Pictured	U13815-01	RAW WATER INLET/AIR CONDITIONER LABEL	1	EA

NOTE: Numbers with letter designations represent parts included with primary numbered part for which there is no photo representation.

PARTS IDENTIFICATION GUIDE

SIGNATURE 310
2006 MODEL YEAR

Cabinets

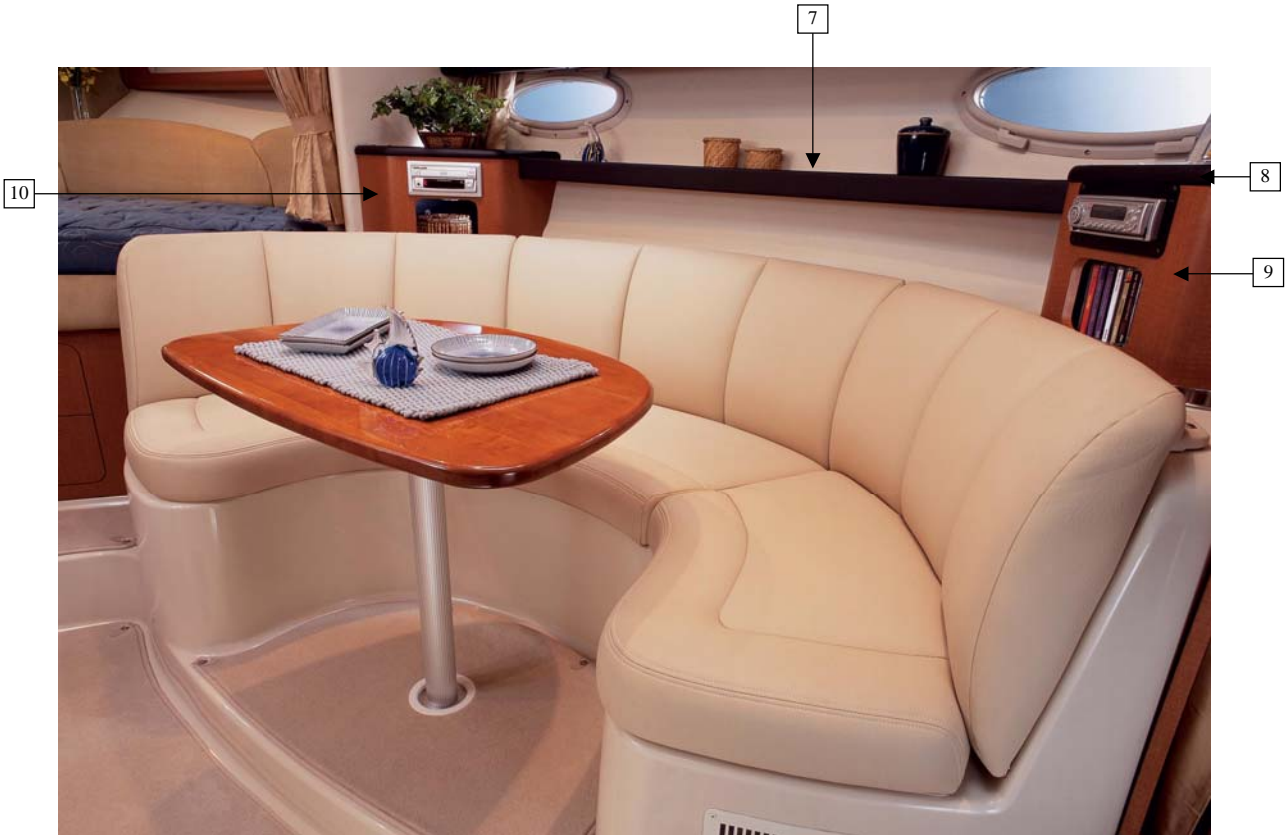

PARTS IDENTIFICATION GUIDE

SIGNATURE 310 **2006 MODEL YEAR**

Cabinets

Item No.	Part Number	Description	Qty.	U.O.M.
1	6.93185	SIG 310 V-BERTH PORT POCKET CABINET	1	EA
2	6.93186	SIG 310 V-BERTH STARBOARD POCKET CABINET	1	EA
3	6.93183	SIG 310 V-BERTH DRAWER BOX UPPER DRAWER	1	EA
3a	423.37.755	22" DRAWER RUNNER (Part of Each Drawer)	1	PR
4	6.93184	SIG 310 V-BERTH DRAWER BOX LOWER DRAWER	1	EA
4a	423.37.755	22" DRAWER RUNNER (Part of Each Drawer)	1	PR
5	6.93180	SIG 310 V-BERTH DRAWER BOX ASSEMBLY (Complete)	1	EA
5a	6.93182	SIG 310 V-BERTH DRAWER BOX FACE	1	EA
5b	6.93181	SIG 310 V-BERTH DRAWER BOX	1	EA
6	24-00001	LATCH- CABINET CAM/SLAM LATCH ASSY. BRUSH NICKEL	2	EA
7	6.93193	SIG 310 DINETTE SHELF	1	EA
8	6.93155	SIG 310 STEREO CABINET C-RAIL PAD COMMON	1	EA
8a	6.93155.900	SIG 310 STEREO CABINET C-RAIL PAD SKIN	1	EA
9	6.93192	SIG 310 STEREO CABINET	1	EA
10	6.93191	SIG 310 DVD CABINET	1	EA

NOTE: Numbers with letter designations represent parts included with primary numbered part for which there is no photo representation.

PARTS IDENTIFICATION GUIDE

SIGNATURE 310
2006 MODEL YEAR

Cabinets



PARTS IDENTIFICATION GUIDE**SIGNATURE 310****2006 MODEL YEAR****Cabinets**

Item No.	Part Number	Description	Qty.	U.O.M.
1	6.93188	SIG 310 DINETTE SPEAKER CABINET DOOR	3	EA
1a	L270 42-00005	LID STAY S/S SATIN LOCK OPEN	3	EA
2	24-00001	LATCH- CABINET CAM/SLAM LATCH ASSY. BRUSH NICKEL	4	EA
3	6.93223	SIG 310 SPEAKER COVER	2	EA
3a	JBLMS610BB	6 1/2IN BLK JBL SPEAKER	2	EA
3b	SFT012-TC-72-MLX/A	LIGHT- 72" SOFT TOUCH LIGHT (Underneath Dinette Cabinet)	1	EA
4	6.92983	SIG 310 DINETTE CABINET LOWER TRIM BOARD COMMON	1	EA
4a	6.92983.900	SIG 310 DINETTE CABINET LOWER TRIM BOARD SKIN	1	EA
5	6.93187	SIG 310 DINETTE SPEAKER CABINET	1	EA
5a	1734-018-BLK	7/8 PVC BLACK EDGE BAND	75	FT
5b	10760	300 SERIES HINGE NICKEL	6	EA
6	6.92982	SIG 310 DINETTE CABINET UPPER TRIM BOARD COMMON	1	EA
6a	6.92982.900	SIG 310 DINETTE CABINET UPPER TRIM BOARD SKIN	1	EA
7	6.93189	SIG 310 AFT BERTH HANGING LOCKER	1	EA
8	6.93190	SIG 310 AFT BERTH HANGING LOCKER DOOR	1	EA
8a	90110	165 DEGREE HINGE NO DOWEL	2	EA

NOTE: Numbers with letter designations represent parts included with primary numbered part for which there is no photo representation.

PARTS IDENTIFICATION GUIDE

SIGNATURE 310 2006 MODEL YEAR

Cabinets



PARTS IDENTIFICATION GUIDE**SIGNATURE 310****2006 MODEL YEAR****Cabinets**

Item No.	Part Number	Description	Qty.	U.O.M.
1	6.93176	SIG 310 MICROWAVE CABINET	1	EA
1a	571.52.208	VENTILATION GRILL PL.CHR. (Part of Upper Cabinet)	1	EA
1b	IST12300B	MICROWAVE BOARD-2005	1	EA
2	24-00001	LATCH- CABINET CAM/SLAM LATCH ASSY. BRUSH NICKEL	9	EA
3	6.93177	SIG 310 MICROWAVE CABINET DOOR (Part of Upper Cabinet)	2	EA
3a	42-00005	HINGE - ADJUSTABLE FLAP JOINT STAY	1	EA
3b	42-00006	HINGE - ADJUSTABLE FLAP JOINT STAY	1	EA
4	6.93178	SIG 310 GALLEY HANGING LOCKER	1	EA
5	6.93172	SIG 310 GALLEY SPICE CABINET COUNTER TOP	1	EA
6	6.93171	SIG 310 GALLEY SPICE CABINET	1	EA
6a	588-1060003	PLEXIGLASS - SLIDING DOOR KIT - CABINET S270	1	EA
7	6.93179	SIG 310 GALLEY HANGING LOCKER DOOR	1	EA
7a	90110	165 DEGREE HINGE NO DOWEL	6	EA
7b	13158	FACE FRM PLATE	6	EA
7c	803.03.700	WARDROBE TUBE SUPPORT	4	EA
7d	801.23.700	WARDROBE TUBE 19X2500MM	0.38	EA
8	6.93170.910	SIG 310 GALLEY COUNTER TOP (LOWER)	1	EA
8a	6.93165	SIG 310 LOWER GALLEY COMPLETE	1	EA
9	6.93167	SIG 310 GALLEY UPPER DRAWER	1	EA
9a	423.35.311	12" WHITE DRAWER RUNNER (Part of Drawer)	1	PR
10	6.93166	SIG 310 LOWER GALLEY DOOR	1	EA
11	6.93168	SIG 310 GALLEY MIDDLE DRAWER	1	EA
11a	423.35.311	12" WHITE DRAWER RUNNER (Part of Drawer)	1	PR
12	6.93226	SIG 310 LOWER GALLEY LOWER MIDDLE DRAWER	1	EA
12a	423.35.311	12" WHITE DRAWER RUNNER (Part of Drawer)	1	PR
13	6.93169	SIG 310 GALLEY LOWER DRAWER	1	EA
13a	423.35.419	16" WHITE DRAWER RUNNER	1	PR
14	6.93173	SIG 310 GALLEY REFRIGERATOR CABINET	1	EA
15	6.93174.910	SIG 310 GALLEY COUNTER TOP	1	EA
16	6.93175	SIG 310 COFFEE CABINET	1	EA
17	6.92980	SIG 310 GALLEY CABINET LOWER TRIM BOARD COMMON	1	EA
17a	6.92980.900	SIG 310 GALLEY CABINET LOWER TRIM BOARD SKIN	1	EA
18	6.92981	SIG 310 GALLEY CABINET UPPER TRIM BOARD COMMON	1	EA
18a	6.92981.900	SIG 310 GALLEY CABINET UPPER TRIM BOARD SKIN	1	EA

Parts Not Pictured Which Are Associated With Cabinets:

Not Pictured	1056-000-CHR	ELBOW CATCH	1	EA
Not Pictured	12634	120 DEG. OVERLAY HINGE	10	EA
Not Pictured	1734-018-WHT	7/8 PVC WHITE EDGE BAND	20	LFT
Not Pictured	421.60.930	TV - EXTENSION 110LB. 1.89IN X 14.1	1	EA
Not Pictured	52-00010	EDGEBANDING - AFRICAN LIMBA MATCH 5	85	FT
Not Pictured	6.90247	SIG 310 SINK LID	1	EA
Not Pictured	OCL-2-MB	LIGHT - OVAL COURTESY WHITE W/ BULLET (Closet Light)	1	EA
Not Pictured	OCLR-2P	MOUNTING RING - OVAL WHITE SPECIAL (Closet Light)	1	EA
Not Pictured	R-1811	BRACKET - SS SWITCH HOUSING	1	EA

NOTE: Numbers with letter designations represent parts included with primary numbered part for which there is no photo representation.

PARTS IDENTIFICATION GUIDE

SIGNATURE 310
2006 MODEL YEAR

Cabinets



1

2



4

3

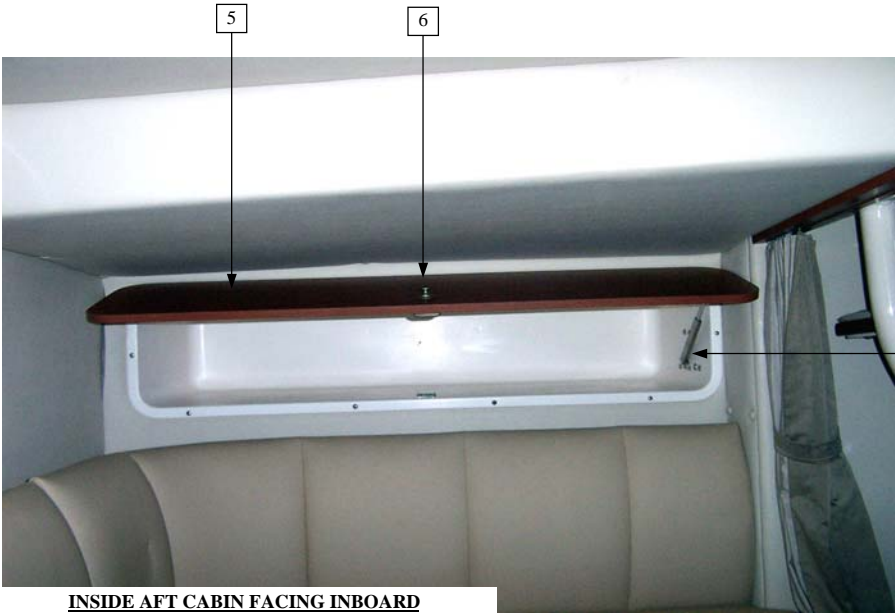

5

6

7

INSIDE AFT CABIN FACING INBOARD

PARTS IDENTIFICATION GUIDE**SIGNATURE 310****2006 MODEL YEAR****Cabinets**

Item No.	Part Number	Description	Qty.	U.O.M.
1	6.93255	SIG 310 HEAD DOOR	1	EA
1a	CB15072-A	6FT ALUM. HINGE	1	EA
1b	4-1086	LG HEAD DOOR MIRROR 1/4IN	1	EA
1c	305-5808-1/4	MIRROR CLIPS 1/4 PLASTIC	4	EA
2	571.52.208	VENTILATION GRILL PL.CHR.	2	EA
3	6.92771.910	SIG 310 HEAD COUNTER TOP	1	EA
4	6.93162	SIG 310 MEDICINE CABINET	1	EA
4a	99136	3 1/4 X 2 1/4 1/4" OFFSET	3	EA
4b	CB10614-04SS	1.06 X 14.50 .04SS C'SUNK (Hinge)	1	EA
4c	IST34123	TRANSOM DOOR STOP	1	EA
4d	IST34059	SUNESTA LATCH	1	EA
4e	6900	ROTARY CATCH (Part of Cabinet)	1	EA
5	6.93194	SIG 310 AFT BERTH DOOR	1	EA
5a	10760	300 SERIES HINGE NICKEL	2	EA
5b	12350	COVER CAPS	1	EA
5c	CB15072-A	6FT ALUM. HINGE	1	EA
6	24-00001	LATCH- CABINET CAM/SLAM LATCH ASSY. BRUSH NICKEL	1	EA
7	18524	120 DEGREE NO DOWELS	2	EA

Parts Not Pictured Which Are Associated With Cabinets:

Not Pictured	6.03224	HEAD MIRROR	1	EA
Not Pictured	305-5808-1/4	MIRROR CLIPS 1/4 PLASTIC	4	EA

NOTE: Numbers with letter designations represent parts included with primary numbered part for which there is no photo representation.

PARTS IDENTIFICATION GUIDE

SIGNATURE 310
2006 MODEL YEAR

Deck-Underside



STARBOARD DASH/HELM AREA

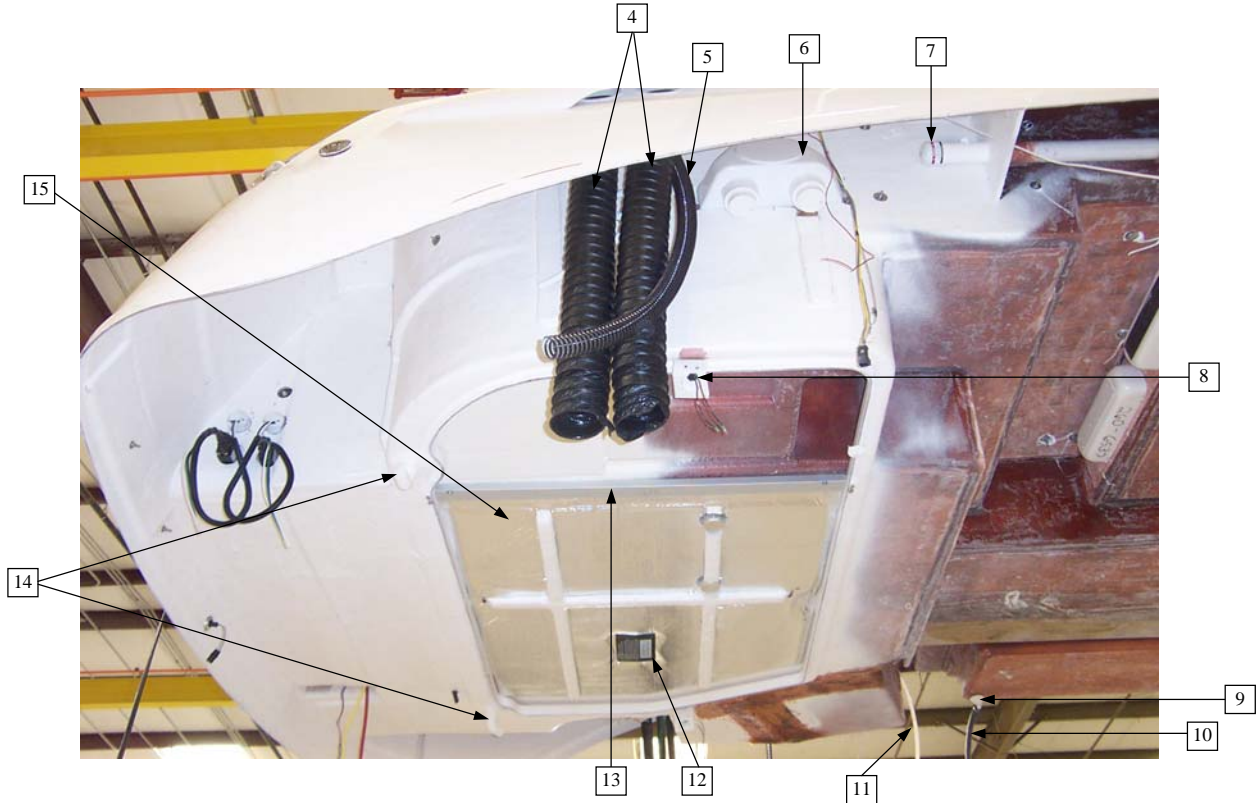

STARBOARD STERN AREA

PARTS IDENTIFICATION GUIDE**SIGNATURE 310****2006 MODEL YEAR****Deck-Underside**

Item No.	Part Number	Description	Qty.	U.O.M.
1	PC2	2 INCH PVC CAP	1	EA
2	CB-4W	4.5IN WHITE MTR WELL BOOT	2	EA
3	49800220	FIRE EXTINGUISHER BOX	2	EA
4	402-4000	4 INCH BLACK VINYL VENT	2 @ 4	FT
5	141-1120	1 1/2 IN MULTIFLEX-BLACK	4.5	FT
6	54400720	S300 TUB CUPHOLDER	1	EA
7	U19848-01	DANGER LABEL - RESEAL	1	EA
8	4-0126	COURTESY LIGHT BRACKET	2	EA
8a	CLML-3-MB	SAND COURTESY LIGHT W/ M. BULLET	2	EA
9	APD-290F	90 DEG. WHITE FLAT DRAIN	1	EA
10	141-0340	3/4 IN. MULTIFLEX	2	FT
11	C1/2X100PEX	1/2 IN. PEX COLD COIL	4.5	FT
12	210-00518-F	OIL DISCHARGE FACEPLATE	1	EA
13	4-1081	S310 ENGINE LID CHANNEL	1	EA
14	TH-1592	1 1/2 90 DEG THRU HULL FITTING WHITE	2	EA
15	500291	1/2 FOIL FACE FOAM MYLAR BAC	1.61	LYD

Parts Not Pictured Which Are Associated With Deck-Underside:

Not Pictured	141-1180	1 1/8 IN. MULTIFLEX	2	FT
Not Pictured	29-00002	6 X 6 AIR VENT	2	EA
Not Pictured	402-3000	3 IN. BLOWER/VENT HOSE-BLK	4.5	FT

NOTE: Numbers with letter designations represent parts included with primary numbered part for which there is no photo representation.

PARTS IDENTIFICATION GUIDE

SIGNATURE 310
2006 MODEL YEAR

Deck-Underside



PORT MIDSHIP AREA



PORT AFT COCKPIT AREA

PARTS IDENTIFICATION GUIDE

SIGNATURE 310 **2006 MODEL YEAR**

Deck-Underside

Item No.	Part Number	Description	Qty.	U.O.M.
1	141-0340	3/4 IN. MULTIFLEX	2	FT
2	C1/2X100PEX	1/2 IN. PEX COLD COIL	4.5	FT
3	402-3000	3 IN.BLOWER/VENT HOSE-BLK	4.5	FT
4	141-0340	3/4 IN. MULTIFLEX	4.5	FT
5	141-0340	3/4 IN. MULTIFLEX	1.5	FT
6	T34	3/4 X 3/4 X3/4 NYLON TEE	1	EA
7	104-1000	1 SANITATION HOSE (Option: Macerator)	5	FT
9	104-1120	1 1/2 SANITATION HOSE	9.5	FT
9a	148-0580	5/8 WHITE SMOOTH PVC HOSE	4.5	FT

Parts Not Pictured which are Associated with Deck Underside

Not Pictured	597	1 1/8-1 1/4 THRU HULL 90@ (Step Well Drain)	1	EA
--------------	-----	---	---	----

NOTE: Numbers with letter designations represent parts included with primary numbered part for which there is no photo representation.

PARTS IDENTIFICATION GUIDE

SIGNATURE 310 2006 MODEL YEAR

Engine Well

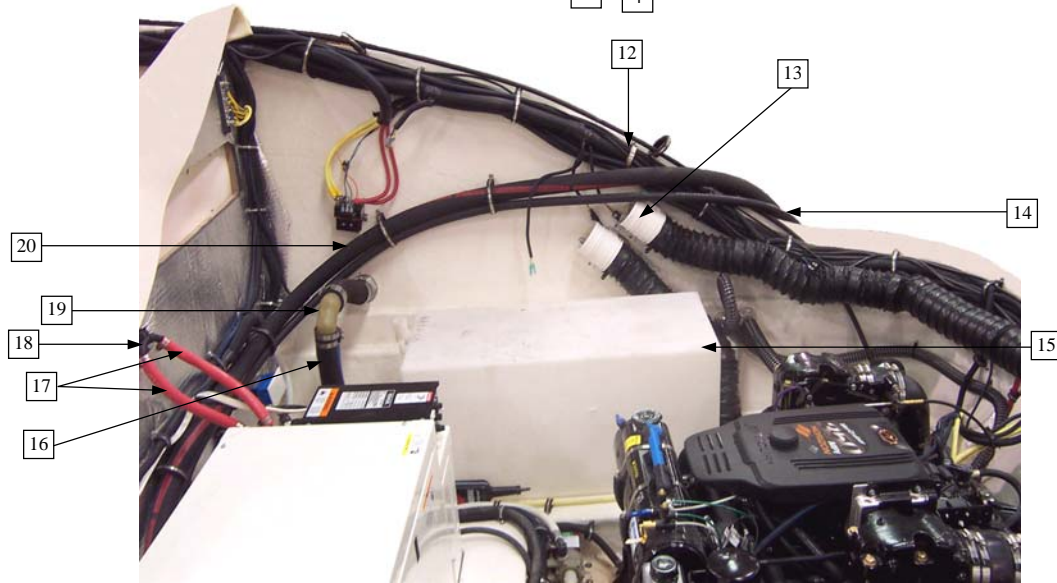
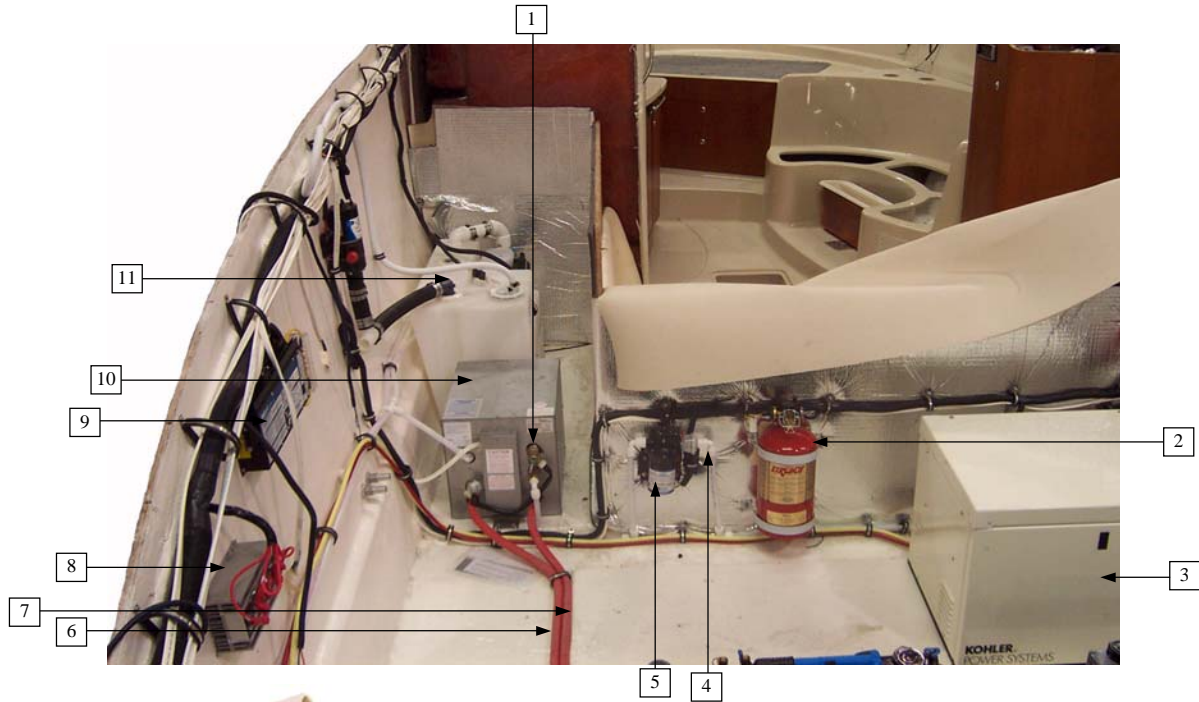

AFT

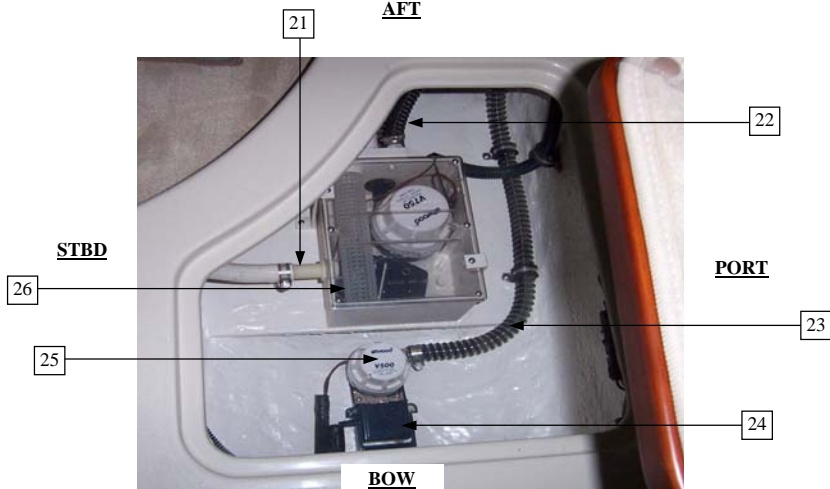

PARTS IDENTIFICATION GUIDE**SIGNATURE 310****2006 MODEL YEAR****Engine Well**

Item No.	Part Number	Description	Qty.	U.O.M.
1	3/8RC	ROMEX CONNECTOR	1	EA
1a	P8N12C	1/2XCLOSE S80 PVC NIPPLE	1	EA
2	17-00005	FIRE EXTINGUISHER - 250/FE241 DOMESTIC	1	EA
2a	17-00011	FIRE EXTINGUISHER - 250/227 INTERNATINAL (Option: Int'l Fire Ext & CE Pkgs)	1	EA
3	4EFCBSSS	3.5KW GEN. W/SOUND SHIELD (Option: Int'l Gasoline Generator)	1	EA
3a	4EFOZCBSSS	GENERATOR DIESEL 220VOLT 50HZ (Option: Int'l Diesel Generator)	1	EA
3b	5ECBSSS	S300 GENERATOR 60 HZ. (Option: Gasoline Generator)	1	EA
3c	5EOZCBSSS	GENERATOR DIESEL 110 VOLT 60HZ (Option: Diesel Generator)	1	EA
3c	500MA10	FUEL FILTER RACOR 10 MICRON (Option: Diesel Generators)	1	EA
3d	2503-8-6	ELBOW - STEEL 90 DEGREE 3/8 FLARE (Option: Diesel Generators)	2	EA
3d	30682-6-6B	FITTING - BRASS STRAIGHT 3/8 FLARE (Option: Diesel Generators)	2	EA
4	170-061-00	FILTER 1/2 IN. PIPE THRED	1	EA
5	2095-223-644	SHURFLO PUMP CE W/PLUG	1	EA
6	132-0580R	5/8 HD WATER HEATER HOSE (Volvo Engines)	10	FT
6a	132-0580R	5/8 HD WATER HEATER HOSE (Mercruiser Engines)	9.5	FT
7	132-0580R	5/8 HD WATER HEATER HOSE (Volvo Engines)	7.25	FT
7a	132-0580R	5/8 HD WATER HEATER HOSE (Mercruiser Engines)	9.5	FT
8	93-B1702/3C-A	70AMP 2ALT 3BANK ISOLATOR	1	EA
9	61240	12 VOLT - 40 AMP CHARGER	1	EA
10	F600	110V HOT WATER HEATER	1	EA
10a	F650	6GL 220V HOT WATER HEATER (Int'l. & CE Pkgs)	1	EA
11	319018007	VACUFLUSH KIT 28+ HTS	1	EA
12	319018008	VACUFLUSH KIT W/OVBD 28+ HTS (Option: Macerator)	1	EA
13	35440-0000D	BLOWER	2	EA
14	360-0580	5/8 FUEL LINE TYPE A1	10.5	FT
15	97-1539	S300 WATER TANK	1	EA
15a	118-CHAPIX10	RUBBER 1/4 X 1 INCH	3.5	FT
15b	4-0146	1.5 X 1.5 X 1/8 4 INCH BRACKET	2	EA
15c	EL112	11/2 MPT 11/2HBB NYLCPL90	1	EA
15d	EL3458	3/4 MPT 5/8HBB NYL CPL 90	1	EA
15e	F06868	1/2PX3/4MPT MALE ADAPTER	1	EA
16	200-2000	2 IN SOFTWALL EXH. HOSE (Option: Generator)	1.5	FT
17	132-0580R	5/8 HD WATER HEATER HOSE (Option: Domestic Generators)	2 @ 1.5	FT
18	1/4AL.ASV	1/4 ALM ANTI SIPHON VALVE (Option: Generator)	1	EA
19	EL-020-0090	90 DEGREE EXHAUST EL W (Option: Generator)	1	EA
20	350-1120L	1 1/2IN FUEL FILL HOSE	10.5	FT
21	301-4A	5/8 IN. PLASTIC THRU-HULL (Option: Air Conditioning)	1	EA
22	141-0340	3/4 IN. MULTIFLEX	11	FT
23	141-0340	3/4 IN. MULTIFLEX	12	FT
24	4202P1	FLOAT SWITCH W/O COVER PACKARD PLUG	1	EA
25	4204PC1	BILGE PUMP 500 GPH W/PLUG	1	EA
26	4141PF1	SHOWER SUMP PUMP DELUXE W/PACKARD PLUG	1	EA

Parts Not Pictured which are Associated with Engine Well :

Not Pictured	M-1-NF-C	GAS VAPOR DETECTOR (Option: Gas Vapor Detector)	1	EA
--------------	----------	---	---	----

NOTE: Numbers with letter designations represent parts included with primary numbered part for which there is no photo representation.

PARTS IDENTIFICATION GUIDE

SIGNATURE 310
2006 MODEL YEAR

Engine Well

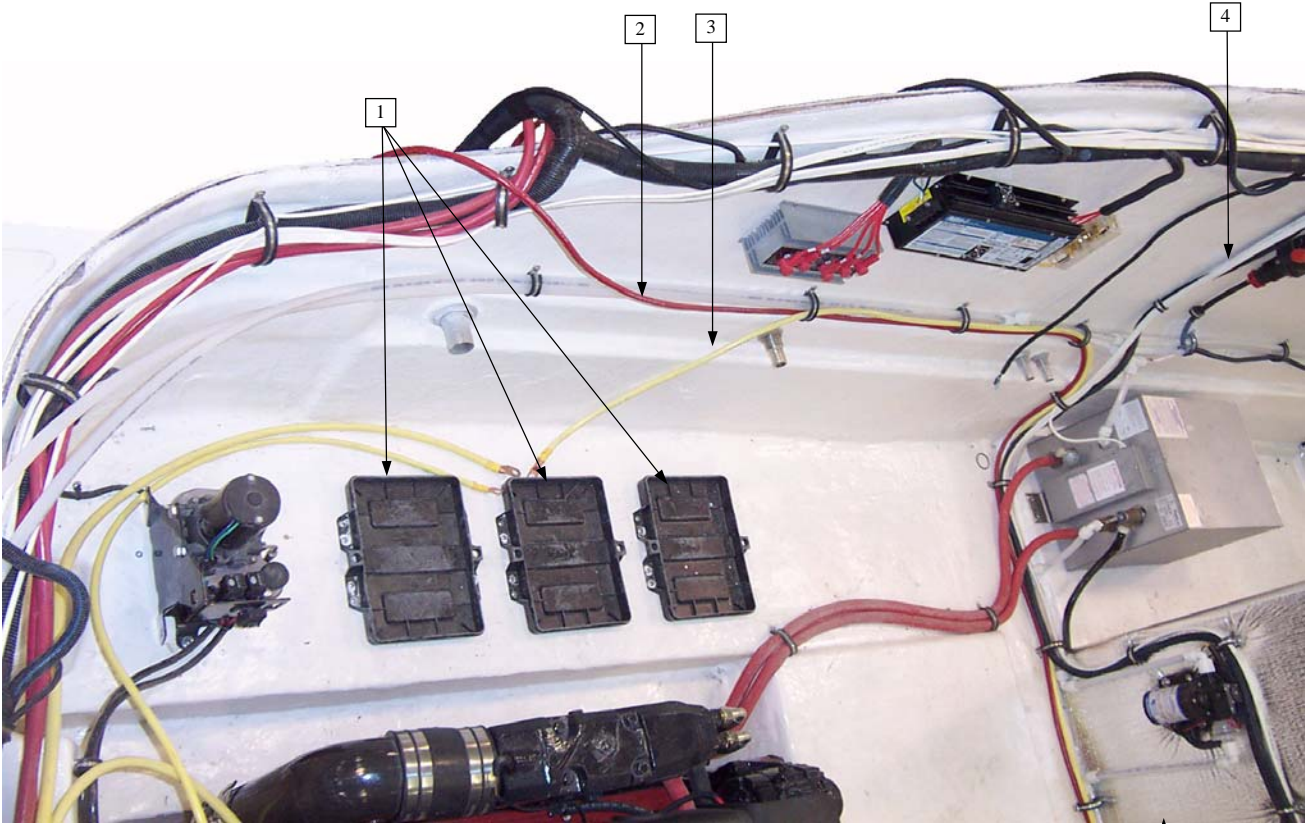

PORT ENGINE WELL FLOOR

5

PARTS IDENTIFICATION GUIDE**SIGNATURE 310****2006 MODEL YEAR****Engine Well**

Item No.	Part Number	Description	Qty.	U.O.M.
1	9091-1	BATTERY TRAY 27 SERIES BATTERY	3	EA
1a	9067-1	BATTERY BOX POWER GUARD 27 BLACK (CE Pkgs)	3	EA
2	GEN-252-R2	252" GA. GEN CABLE (Option: Generator)	1	EA
3	GEN-192-Y2	192" 2GA YELLOW CABLE (Option: Generator)	1	EA
3a	458NOV02	DUAL BATT. BOOT RED	3	EA
3b	458NOV14	DUAL BATT. BOOT BLACK	3	EA
3c	600N7V02	DUAL POST BATT. COVER RED	3	EA
3d	600N7V14	DUAL POST BATTERY BLACK	3	EA
4	100-0340	3/4 HARDWALL WATER HOSE	6	FT
5	500291	1/2 FOIL FACE FOAM MYLAR BAC	4.91	LYD

Parts Not Pictured Which Are Associated With Engine Well:

Not Pictured	118-CHAPIX10	RUBBER 1/4 X 1 INCH	20	FT
Not Pictured	31608	147GAL FUEL TANK W/ FILTER	1	EA
Not Pictured	391022	SHUT OFF VALVE - ALUMINUM 3/8 MNPT X 3/8 FNPT (CE Pkgs)	1	EA
Not Pictured	48033	3/8 ALUMINUM PLUG	1	EA
Not Pictured	116B04	1/4 FORGED BRASS ST ELBOW	2	EA
Not Pictured	HN0337	17" TRANSDUCER HRNS	1	EA
Not Pictured	SN1020	THRU HULL TRANSDUCER	1	EA
Not Pictured	4201P1	AUTO FLOAT SWITCH W/COVER PACKARD	1	EA
Not Pictured	4202P1	FLOAT SWITCH W/O COVER PACKARD PLUG	1	EA
Not Pictured	4212P1	V1250 BILGE PUMP PACKARD PLUG INSTA	1	EA
Not Pictured	4-1099X	V1250 BILGE PUMP BRACKET	1	EA
Not Pictured	DBN32	1/4X3/8 BRASS BARB HOSE	2	EA
Not Pictured	123-0120	1/2 FLAME RET.SPLIT COND.	30	FT
Not Pictured	4-0146	1.5 X 1.5 X 1/8 4 INCH BRACKET	1	EA
Not Pictured	4-1000	FIRE EXTINGUISHER BRACKET	1	EA
Not Pictured	4-1013	4 INCH FUEL TANK BRACKET	1	EA
Not Pictured	402-4000	4 INCH BLACK VINYL VENT	3.75	FT
Not Pictured	402-4000	4 INCH BLACK VINYL VENT	12.67	FT
Not Pictured	C-15-25.250	ACTUATOR 310SIG 19IN. HATCH LIFT 10	1	EA
Not Pictured	U17408-01	LEAKING FUEL DECAL	1	EA
Not Pictured	203-00180	HARNESS- SEA KEY HARNESS (Option: Seakey)	1	EA
Not Pictured	3863074	SEAKEY MARINE SATCOMM UNIT (Option: Seakey)	1	EA
Not Pictured	3863079	MARINE SATCOMM CABLE 30FT. (Option: Seakey)	1	EA
Not Pictured	4202-1	AUTO FLOAT SWTCH-NO COVER FWD (Option: Seakey)	1	EA
Not Pictured	141-1120	1 1/2 IN MULTIFLEX-BLACK (CE Pkgs)	3	FT
Not Pictured	141-1120	1 1/2 IN MULTIFLEX-BLACK (CE Pkgs)	10.5	FT
Not Pictured	954DP2	DIAPHRAGM PUMP W/SS HAND. (CE Pkgs)	1	EA
Not Pictured	230-00796-K	99-DUAL FUEL SHUTOFF KIT (Int'l. Fuel Shut Off)	1	EA
Not Pictured	4720K15	FUEL TROL (Int'l. Fuel Shut Off)	2	EA
Not Pictured	DBN32	1/4X3/8 BRASS BARB HOSE (Int'l. Fuel Shut Off)	4	EA

NOTE: Numbers with letter designations represent parts included with primary numbered part for which there is no photo representation.

PARTS IDENTIFICATION GUIDE

SIGNATURE 310
2006 MODEL YEAR

Battery Cable Routing

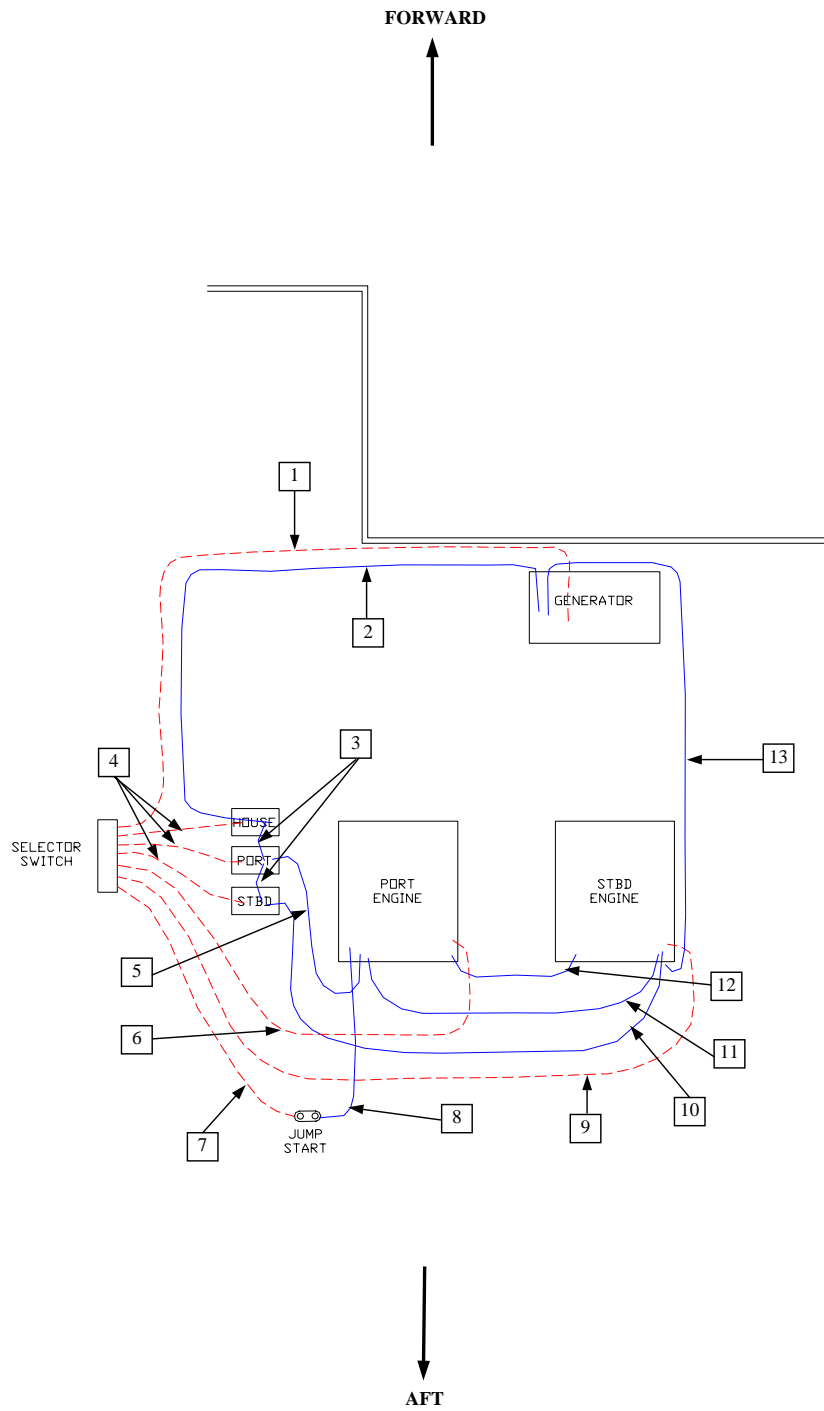

PARTS IDENTIFICATION GUIDE**SIGNATURE 310****2006 MODEL YEAR****Battery Cable Routing**

Item No.	Part Number	Description	Qty.	U.O.M.
1	GEN-252-R2	252" 2GA GEN. CABLE (Option: Generator)	1	EA
2	GEN-192-Y2	192" 2GA YELLOW CABLE (Option: Generator)	1	EA
3	20-018-Y2	18IN GROUND BATTERY CABLE 2GA YELLOW	2	EA
4	20-048-R2	48IN POSITIVE BATT.CABLE 2GA RED	3	EA
5	20-060-Y2	60IN GROUND BATTERY CABLE 2GA YELLOW	1	EA
6	20-144-ROO	144IN 2/0 POSITIVE BATT. CABLE RED	1	EA
7	20-096-RO	96IN 1/0 POSITIVE BATTERY CABLE RED	1	EA
8	20-048-Y2	48IN GROUND BATTERY CABLE 2GA YELLOW	1	EA
9	20-180-ROO	180IN 2/0 POSITIVE BATT. CABLE RED	1	EA
10	20-144-YOO	144IN 2/0 GROUND BATTERY CABLE-YELLOW	1	EA
11	20-084-YO	84IN 1/0 GROUND BAT.CABLE YELLOW	1	EA
12	20-060-Y2	60IN GROUND BATTERY CABLE 2GA YELLOW	1	EA
13	GEN-120-Y2	120" 2GA YELLOW CABLE (Option: Generator)	1	EA

NOTE: Numbers with letter designations represent parts included with primary numbered part for which there is no photo representation.

PARTS IDENTIFICATION GUIDE**SIGNATURE 310
2006 MODEL YEAR****Engine Well / Complete Generator Options**

Part Number	Description	Qty.	U.O.M.
Common Parts			
1/4ALASV	1/4 ALM ANTI SIPHON VALVE	1	EA
493-5	3/4 WATER STRAINER (1990)	1	EA
65-007-51	3/4 PIPE HOSE ADAPTER	1	EA
71008	2IN. SS THRU HULL	1	EA
78-115-01	3/4 BRONZE SEA FLANGE	1	EA
DBN66	3/4MPT 3/4HBB BRS CPL	2	EA
EL-020-0090	90 DEGREE EXHAUST EL W	1	EA
L567205	3/4 BRONZE THRU HULL	1	EA
LABEL-GENERATOR	GEN. BATTERY CABLE LABEL	2	EA
U13814-01	RAW WATER INLET/GENERATOR LABEL	1	EA
Gasoline Common Parts			
100-0340	3/4 INCH HARDWALL WATER HOSE	1	FT
100-0340	3/4 INCH HARDWALL WATER HOSE	6	FT
100W1X1/4	WHITE TEXTURE TRIM 5000FT PRICE	0.25	FT
118-CHAPIX10	RUBBER 1/4 X 1 INCH	0.40	FT
132-0580R	5/8 HD WATER HEATER HOSE	2 @ 1.50	FT
360-0140	1/4IN TYPE A FUEL HOSE	4.50	FT
GEN-120-Y2	120" 2GA. YELLOW CABLE	1	EA
GEN-192-Y2	192" 2GA YELLOW CABLE	1	EA
GEN-252-R2	252" 2GA. GEN CABLE	1	EA
Diesel Common Parts			
100-0340	3/4 INCH HARDWALL WATER HOSE	1.75	FT
200-2000	2IN SOFTWALL EXHAUST HOSE	1.13	FT
200-2000	2IN SOFTWALL EXHAUST HOSE	1.50	FT
360-0140	1/4IN TYPE A FUEL HOSE	0.25	FT
360-0140	1/4IN TYPE A FUEL HOSE	5.08	FT
360-0580	5/8 FUEL LINE TYPE A1	1.42	FT
360-0580	5/8 FUEL LINE TYPE A1	1.33	FT
48039	TANK - FUEL PICKUP ASSEMBLY 1/4 GEN	1	EA
DBN22	1/4 HB X 1/4 MP	1	EA
120 Volt Gasoline Generator Option			
200-2000	2IN SOFTWALL EXHAUST HOSE	1.50	FT
200-2000	2IN SOFTWALL EXHAUST HOSE	1	FT
200-2000	2IN SOFTWALL EXHAUST HOSE	1.33	FT
5ECBSSS	S300 GENERATOR 60 HZ.	1	EA
SA-200-0609	GENERATOR MUFFLER SIG 260/270/290/3	1	EA
220 Volt Gasoline Generator Option			
200-2000	2IN SOFTWALL EXHAUST HOSE	0.75	FT
200-2000	2IN SOFTWALL EXHAUST HOSE	5.83	FT
200-2000	2IN SOFTWALL EXHAUST HOSE	1.66	FT
2503-8-6	ELBOW - STEEL 90 DEGREE 3/8 FLARE X	2	EA
30682-6-6B	FITTING - BRASS STRAIGHT 3/8 FLARE	2	EA
360-0380	3/8 IN. FUEL LINE TYPE A1	3.66	FT
360-0380	3/8 IN. FUEL LINE TYPE A1	1.42	FT
360-0380	3/8 IN. FUEL LINE TYPE A1	6	FT
500MA10	FUEL FILTER RACOR 10 MICRON	1	EA
5EOZCBSSS	GENERATOR DIESEL 110 VOLT 60HZ W/SO	1	EA
XC-CHA-3187	MUFFLER DIESEL GENERATOR 6 X 9 NAQU	1	EA
120 Volt Diesel Generator Option			
100-0340	3/4 INCH HARDWALL WATER HOSE	6	FT
4EFCBSSS	3.5KW GEN. W/SOUND SHIELD	1	EA
GEN-120-Y2	120" 2GA. YELLOW CABLE	1	EA
GEN-192-Y2	192" 2GA YELLOW CABLE	1	EA
GEN-252-R2	252" 2GA. GEN CABLE	1	EA
SA-200-0609	GENERATOR MUFFLER SIG 260/270/290/3	1	EA
220 Volt Diesel Generator Option			
100-0340	3/4 INCH HARDWALL WATER HOSE	2.92	FT
205-00435-A	PANEL 280/290 SIG DSL GENERATOR	1	EA
2503-8-6	ELBOW - STEEL 90 DEGREE 3/8 FLARE X	2	EA
30682-6-6B	FITTING - BRASS STRAIGHT 3/8 FLARE	2	EA
4EFOZCBSSS	GENERATOR DIESEL 220VOLT 50HZ W/SOU	1	EA
500MA10	FUEL FILTER RACOR 10 MICRON	1	EA
GEN-096-Y2	96" 2GA. YELLOW CABLE	1	EA
GEN-144-Y2	144" 2GA YELLOW CABLE	1	EA
GEN-180-R2	180" 2GA RED GEN. CABLE	1	EA

PARTS IDENTIFICATION GUIDE

SIGNATURE 310

2006 MODEL YEAR

Go Back

Fresh Water

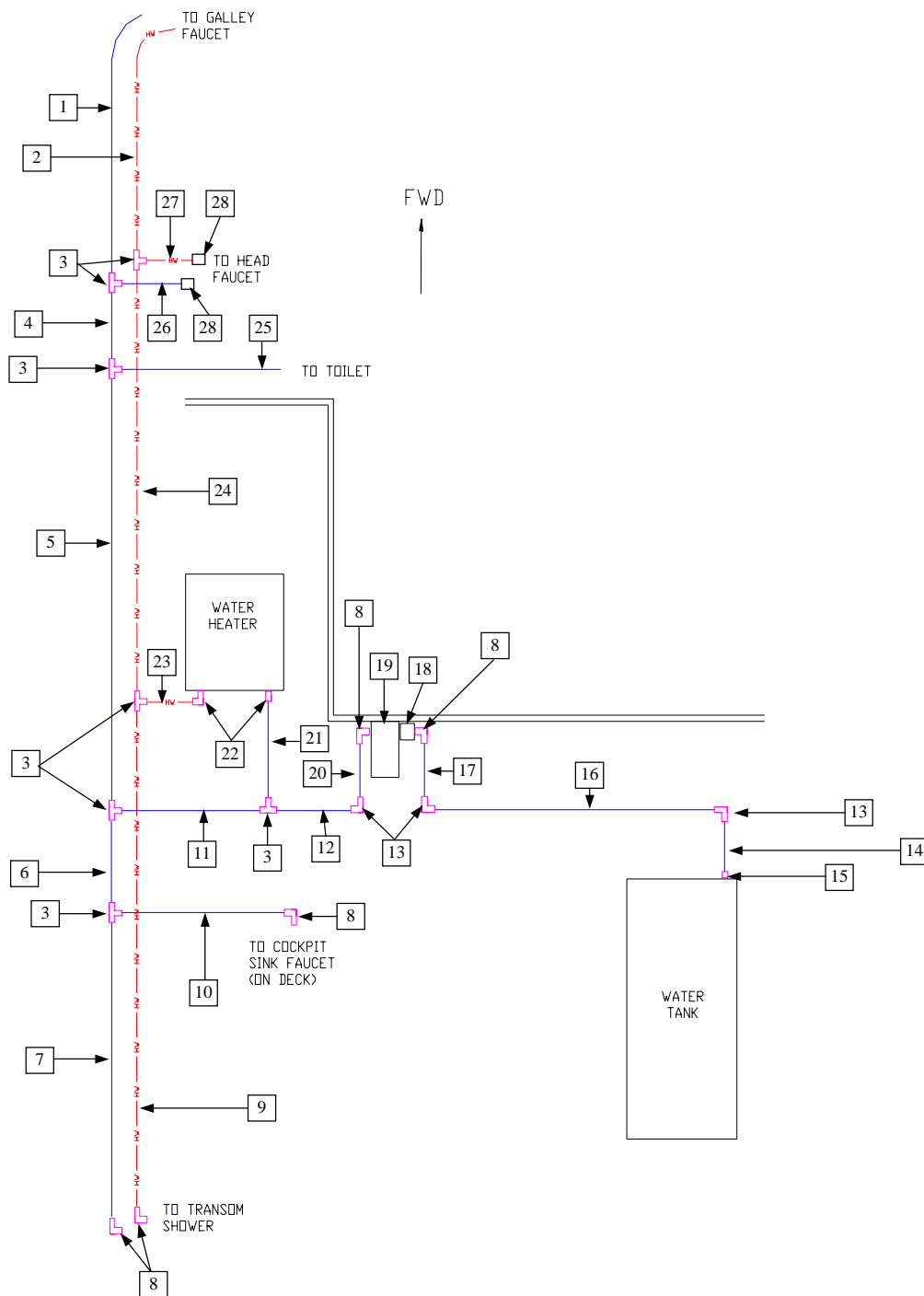

PARTS IDENTIFICATION GUIDE**SIGNATURE 310****2006 MODEL YEAR****Fresh Water**

Item No.	Part Number	Description	Qty.	U.O.M.
1	C1/2X100PEX	1/2 IN. PEX COLD COIL	4	FT
2	H1/2X100PEX	1/2 IN. PEX HOT COIL	4	FT
3	F06820	1/2P X 1/2P X 1/2P TEE	5	EA
4	C1/2X100PEX	1/2 IN. PEX COLD COIL	4.5	FT
5	C1/2X100PEX	1/2 IN. PEX COLD COIL	7	FT
6	C1/2X100PEX	1/2 IN. PEX COLD COIL	2	FT
7	C1/2X100PEX	1/2 IN. PEX COLD COIL	7.5	FT
8	F06816	1/2X1/2 FPT SWIVEL ELBOW	7	EA
9	H1/2X100PEX	1/2 IN. PEX HOT COIL	9.5	FT
10	C1/2X100PEX	1/2 IN. PEX COLD COIL	4.5	FT
11	C1/2X100PEX	1/2 IN. PEX COLD COIL	2	FT
12	C1/2X100PEX	1/2 IN. PEX COLD COIL	1	FT
13	F06800	1/2P X 1/2P 90 DEG. ELBOW	3	EA
14	C1/2X100PEX	1/2 IN. PEX COLD COIL	1.25	FT
15	F06868	1/2PX3/4MPT MALE ADAPTER	1	EA
16	C1/2X100PEX	1/2 IN. PEX COLD COIL	8	FT
17	C1/2X100PEX	1/2 IN. PEX COLD COIL	1	FT
18	170-061-00	FILTER 1/2 IN. PIPE THRED	1	EA
19	2095-223-644	SHURFLO PUMP CE W/PLUG	1	EA
20	C1/2X100PEX	1/2 IN. PEX COLD COIL	1	FT
21	C1/2X100PEX	1/2 IN. PEX COLD COIL	0.5	FT
22	F06803	1/2 P X 1/2 MPT ELBOW	2	EA
23	H1/2X100PEX	1/2 IN. PEX HOT COIL	0.42	FT
23a	CV50BS	1/2 BRASS CHECK VALVE	1	EA
24	H1/2X100PEX	1/2 IN. PEX HOT COIL	8.5	FT
25	C1/2X100PEX	1/2 IN. PEX COLD COIL	5	FT
26	C1/2X100PEX	1/2 IN. PEX COLD COIL	2	FT
27	H1/2X100PEX	1/2 IN. PEX HOT COIL	2	FT
28	F06873	1/2P X 1/2FPT STR SWVL BS	2	EA

NOTE: Numbers with letter designations represent parts included with primary numbered part for which there is no photo representation.

PARTS IDENTIFICATION GUIDE

SIGNATURE 310

2006 MODEL YEAR

Standard Waste & Gray Water System

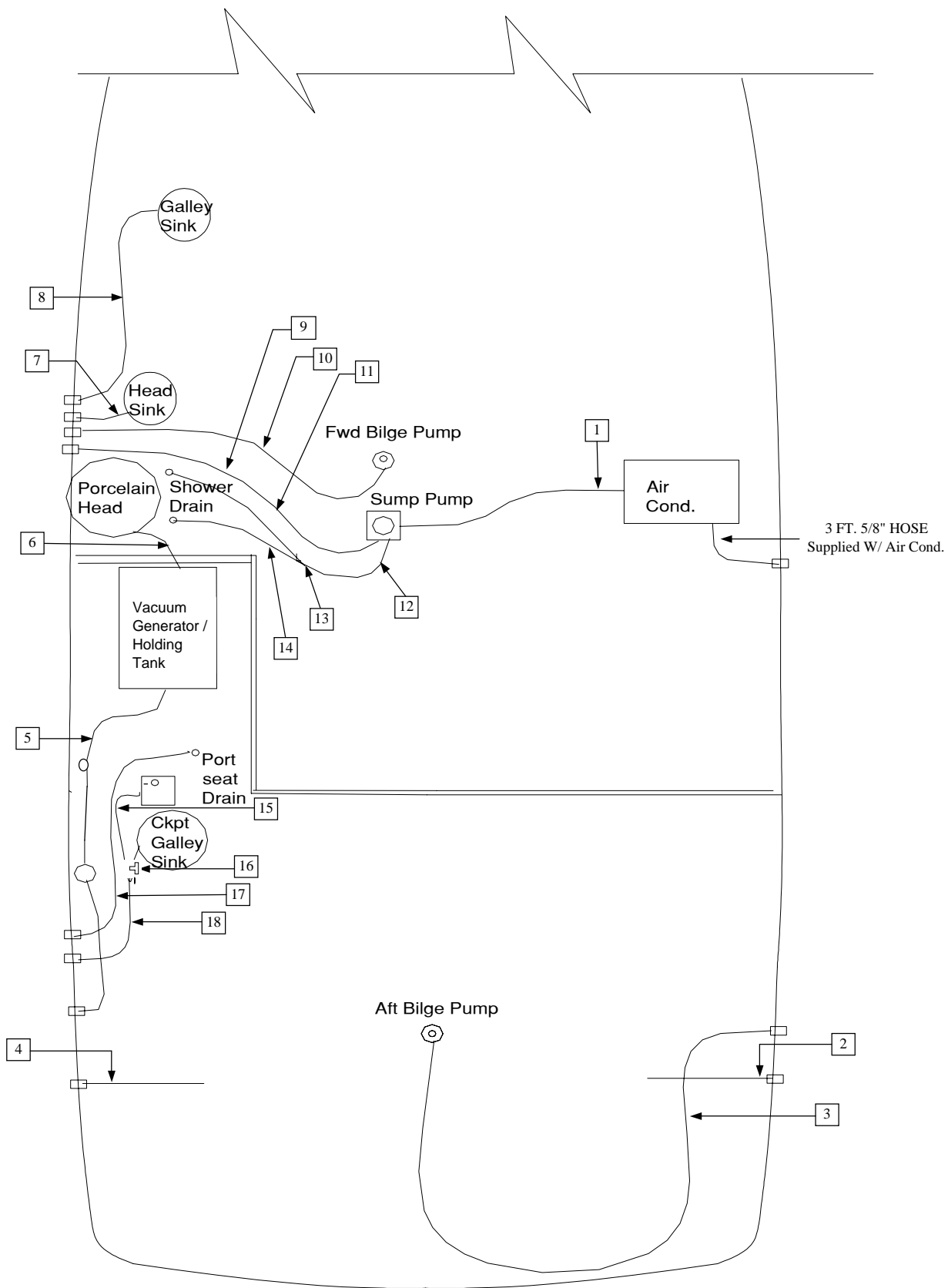

PARTS IDENTIFICATION GUIDE**SIGNATURE 310****2006 MODEL YEAR****Standard Waste & Gray Water System**

Item No.	Part Number	Description	Qty.	U.O.M.
1	148-0580	5/8 WHITE SMOOTH PVC HOSE	6	FT
2	104-1120	1 1/2 SANITATION HOSE	2.50	FT
3	141-1180	1 1/8 IN. MULTIFLEX	12	FT
4	104-1120	1 1/2 SANITATION HOSE	2.50	FT
5	104-1120	1 1/2 SANITATION HOSE	10	9.50 FT
6	104-1120	1 1/2 SANITATION HOSE	4.5	40 FT
7	141-1140	1 1/4 IN. MULTIFLEX	4	FT
8	141-1120	1 1/2 IN MULTIFLEX-BLACK (Galley Sink to Thru Hull)	5	FT
9	141-0340	3/4 IN. MULTIFLEX	11	FT
10	141-0340	3/4 IN. MULTIFLEX	12	FT
11	141-0340	3/4 IN. MULTIFLEX	7	FT
12	141-0340	3/4 IN. MULTIFLEX	3.50	FT
13	1043	3/4 Y BLACK	1	EA
14	141-0340	3/4 IN. MULTIFLEX	7	FT
15	141-0340	3/4 IN. MULTIFLEX	1.50	FT
16	T34	3/4 X 3/4 X 3/4 NYLON TEE	1	EA
17	141-0340	3/4 IN. MULTIFLEX	2	FT
18	141-0340	3/4 IN. MULTIFLEX	4.50	FT

Parts Not Pictured which are Associated with Waste System

Not Pictured	3-1122	SUMP BOX (Option: Gray Water System)	1	EA
Not Pictured	141-0340	3/4 IN. MULTIFLEX (Option: Gray Water System)	13	FT
Not Pictured	141-0340	3/4 IN. MULTIFLEX (Option: Gray Water System)	3	FT
Not Pictured	141-0340	3/4 IN. MULTIFLEX (Option: Gray Water System)	1	FT
Not Pictured	141-1140	1 1/4 IN. MULTIFLEX (Option: Gray Water System)	0.25	FT
Not Pictured	141-1140	1 1/4 IN. MULTIFLEX (Option: Gray Water System)	12	FT
Not Pictured	18660-0121	SELF PRIMING PUMP (Option: Gray Water System)	1	EA
Not Pictured	385310883	ELBOW SEALING GROMMET KIT 3/4 INCH (Option: Gray Water System)	1	EA
Not Pictured	8895	1 1/4 TO 1 1/2 HOSE ADAPT ADAPTER (Option: Gray Water System)	1	EA
Not Pictured	A1234	1/2 MPT 3/4 HBB NYL CPL (Option: Gray Water System)	2	EA
Not Pictured	T114	1 1/4 NYLON TEE (Option: Gray Water System)	1	EA
Not Pictured	T34	3/4 X 3/4 X 3/4 NYLON TEE (Option: Gray Water System)	1	EA
Not Pictured	301-4A	5/8 IN. PLASTIC THRU-HULL (Option: Gray Water System)	1	EA
Not Pictured	301-5	3/4 IN. PLASTIC THRU-HULL (Option: Gray Water System)	2	EA
Not Pictured	3874-1	1 1/8-1 1/4 HULL (Option: Gray Water System)	1	EA
Not Pictured	4202P1	FLOAT SWITCH W/O COVER PACKARD PLUG (Option: Gray Water System)	1	EA
Not Pictured	588-972953	SUMP PUMP LID (Option: Gray Water System)	1	EA

Not Pictured 352-CMB08327G3N 8 AMP CIR BRKR WHITE BUTTON (Option: Gray Water System) 1 EA

NOTE: Numbers with letter designations represent parts included with primary numbered part for which there is no photo representation.

Not Pictured 104-1120 1 1/2 SANITATION HOSE 12 FT

PARTS IDENTIFICATION GUIDE

SIGNATURE 310
2006 MODEL YEAR

Interiors - Overhead View

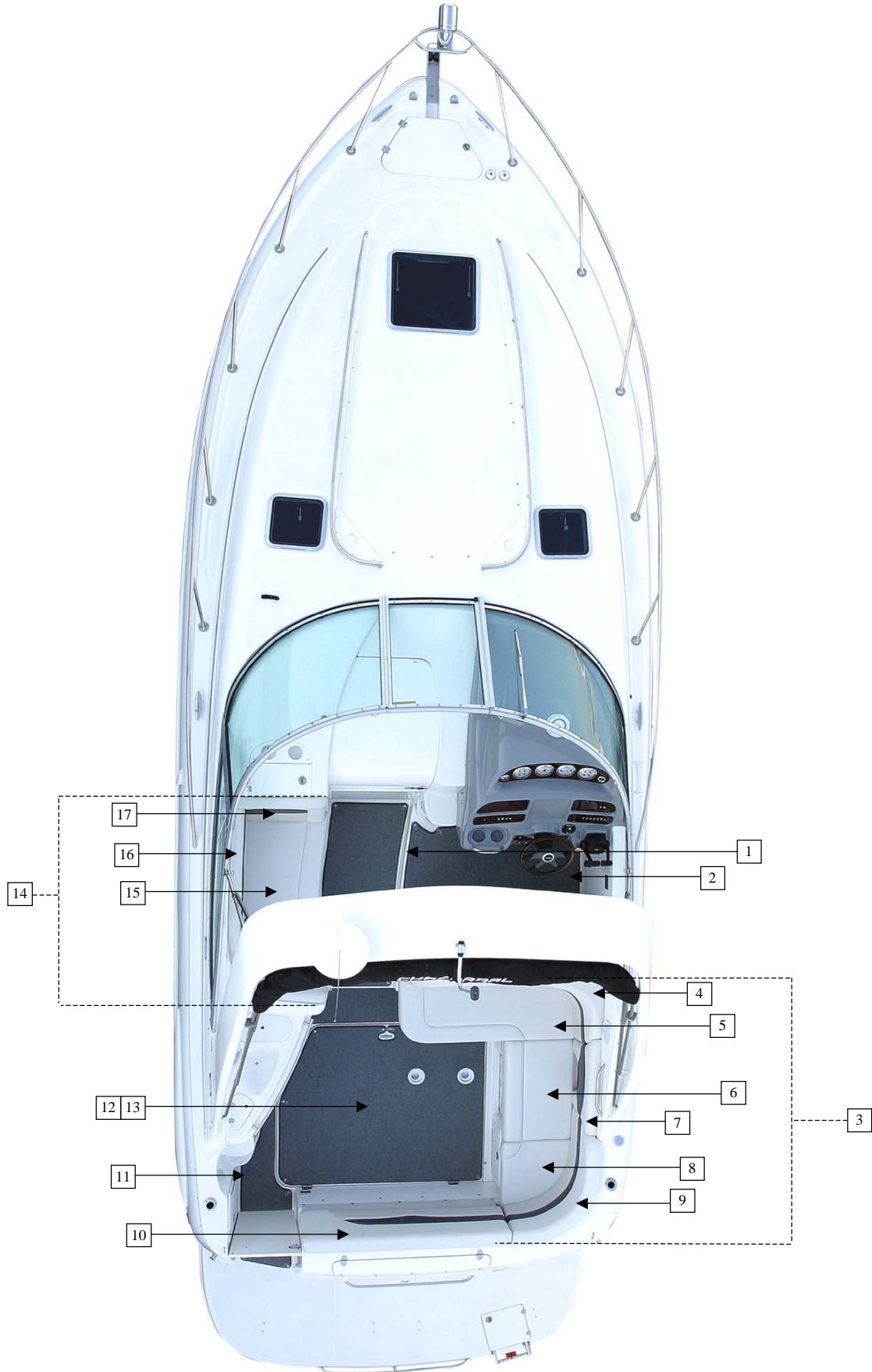

PARTS IDENTIFICATION GUIDE**SIGNATURE 310****2006 MODEL YEAR****Interiors - Overhead View**

Item No.	Part Number	Description	Qty.	U.O.M
1	510.6-S310-101	HELM WALK THRU CARPET #1-CHAMPAGNE	1	EA
2	510.6-S310-102	HELM SEAT FOOTREST CARPET #2-CHAMPAGNE	1	EA
3	6.02911	310SIG STERN SEATING ASSEMBLY COMMON	1	EA
3a	6.02911.901	310SIG STERN SEATING ASSEMBLY SKIN CHAMPAGNE	1	EA
4	6.02917	310SIG STARBOARD FORWARD BACKREST COMMON	1	EA
4a	6.02917.901	310SIG STARBOARD FORWARD BACKREST SKIN CHAMPAGNE	1	EA
5	6.02912	310SIG STARBOARD FORWARD CUSHION COMMON	1	EA
5a	6.02912.901	310SIG STARBOARD FORWARD CUSHION SKIN CHAMPAGNE	1	EA
6	6.02913	310SIG STARBOARD CENTER CUSHION COMMON	1	EA
6a	6.02913.901	310SIG STARBOARD CENTER CUSHION SKIN CHAMPAGNE	1	EA
7	6.02918	310SIG STARBOARD CENTER BACKREST COMMON	1	EA
7a	6.02918.901	310SIG STARBOARD CENTER BACKREST SKIN CHAMPAGNE	1	EA
8	6.02914	310SIG STARBOARD AFT CORNER CUSHION COMMON	1	EA
8a	6.02914.901	310SIG STARBOARD AFT CORNER CUSHION SKIN CHAMPAGNE	1	EA
9	6.02919	310SIG STARBOARD AFT CORNER BACKREST COMMON	1	EA
9a	6.02919.901	310SIG STARBOARD AFT CORNER BACKREST SKIN CHAMPAGNE	1	EA
10	6.02920	310SIG AFT FLIP UP BACKREST COMMON	1	EA
10a	6.02920.901	310SIG AFT FLIP UP BACKREST SKIN CHAMPAGNE	1	EA
11	510.6-S310-104	AFT TRANSOM ENTRY CARPET #4-CHAMPAGNE	1	EA
12	510.6-S310-105	MOTOR LID CARPET #5-CHAMPAGNE	1	EA
13	6.02996.901	310SIG COCKPIT SNAP IN CARPET	1	EA
14	6.02907	310SIG PORT SEAT ASSEMBLY COMMON	1	EA
14a	6.02907.901	310SIG PORT SEAT ASSEMBLY SKIN CHAMPAGNE	1	EA
15	6.02910	310SIG PORT SEAT CUSHION COMMON	1	EA
15a	6.02910.901	310SIG PORT SEAT CUSHION SKIN CHAMPAGNE	1	EA
16	6.02908	310SIG PORT SEAT BACKREST COMMON	1	EA
16a	6.02908.901	310SIG PORT SEAT BACKREST SKIN CHAMPAGNE	1	EA
17	6.02909	310SIG PORT SEAT FORWARD BACKREST COMMON	1	EA
17a	6.02909.901	310SIG PORT SEAT FORWARD BACKREST SKIN CHAMPAGNE	1	EA

Parts Not Pictured Which Are Associated With Deck Overhead:

Not Pictured	6.03227	310SIG STANDARD TUBING KIT	1	EA
Not Pictured	6.02915	310SIG AFT STERN CUSHION COMMON	1	EA
Not Pictured	6.02915.901	310SIG AFT STERN CUSHION SKIN CHAMPAGNE	1	EA
Not Pictured	6.02916	310SIG AFT STERN CUSHION HINGE BOARD	1	EA
Not Pictured	6.02922	310SIG OPTIONAL DECK PAD COMMON	1	EA
Not Pictured	6.02922.901	310SIG OPTIONAL DECK PAD SKIN CHAMPAGNE	1	EA
Not Pictured	6.02921	310SIG COCKPIT TABLE TOP CUSHION COMMON	1	EA
Not Pictured	6.02921.901	310SIG COCKPIT TABLE TOP CUSHION SKIN CHAMPAGNE	1	EA
Not Pictured	510.6-S310-103	COCKPIT GALLEY CARPET #3-CHAMPAGNE	1	EA

NOTE: Numbers with letter designations represent parts included with primary numbered part for which there is no photo representation.

To order a complete part, you must order the common part as well as the skin.

Champagne cockpit part numbers listed above. For Platinum cockpit parts, replace the .901 with a .902.

PARTS IDENTIFICATION GUIDE

SIGNATURE 310
2006 MODEL YEAR

Interiors - Helm Seat

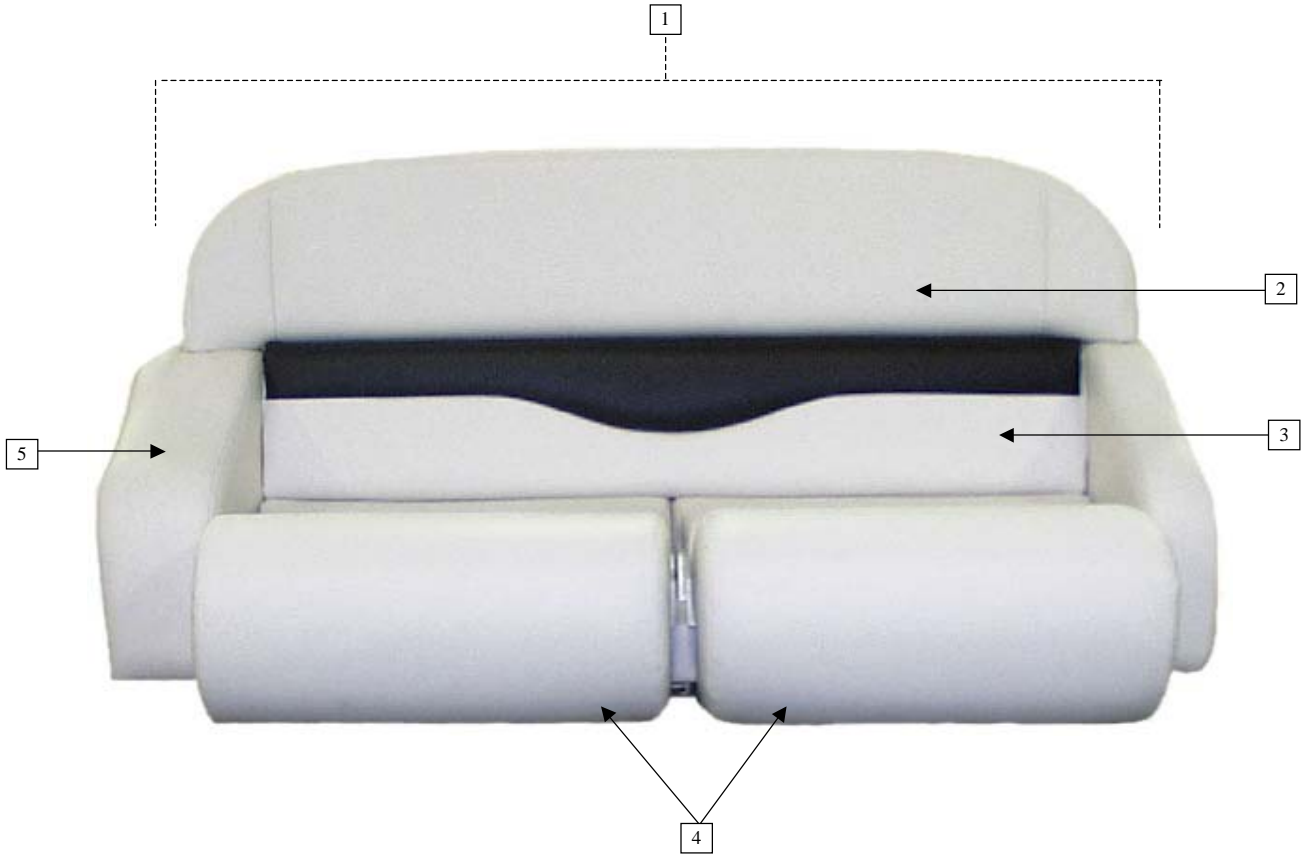

PARTS IDENTIFICATION GUIDE**SIGNATURE 310****2006 MODEL YEAR****Interiors - Helm Seat**

Item No.	Part Number	Description	Qty.	U.O.M
1	6.02901	310SIG HELM SEAT ASSEMBLY COMMON	1	EA
1a	6.02901.901	310SIG HELM SEAT ASSEMBLY SKIN CHAMPAGNE	1	EA
1b	MF1045	2PC. FOLDUP SEAT BRACKET	2	EA
2	6.02904 6.02903	310SIG HELM SEAT HEADREST COMMON	1	EA
2a	6.02904.901 6.02903.901	310SIG HELM SEAT HEADREST SKIN CHAMPAGNE	1	EA
3	6.02903 6.02904	310SIG HELM SEAT BACKREST COMMON	1	EA
3a	6.02903.901 6.02904.901	310SIG HELM SEAT BACKREST SKIN CHAMPAGNE	1	EA
4	6.02906	310SIG HELM SEAT FLIP UP CUSHION COMMON	2	EA
4a	6.02906.901	310SIG HELM SEAT FLIP UP CUSHION SKIN CHAMPAGNE	2	EA
5	6.02902	310SIG HELM SEAT BASE COMMON	1	EA
5a	6.02902.901	310SIG HELM SEAT BASE SKIN CHAMPAGNE	1	EA
6	6.02905	310SIG HELM SEAT CUSHION COMMON	2	EA
6a	6.02905.901	310SIG HELM SEAT CUSHION SKIN CHAMPAGNE	2	EA

NOTE: Numbers with letter designations represent parts included with primary numbered part for which there is no photo representation.

To order a complete part, you must order the common part as well as the skin.

Champagne cockpit part numbers listed above. For Platinum cockpit parts, replace the .901 with a .902.

PARTS IDENTIFICATION GUIDE

SIGNATURE 310

2006 MODEL YEAR

Interiors - Forward Bow

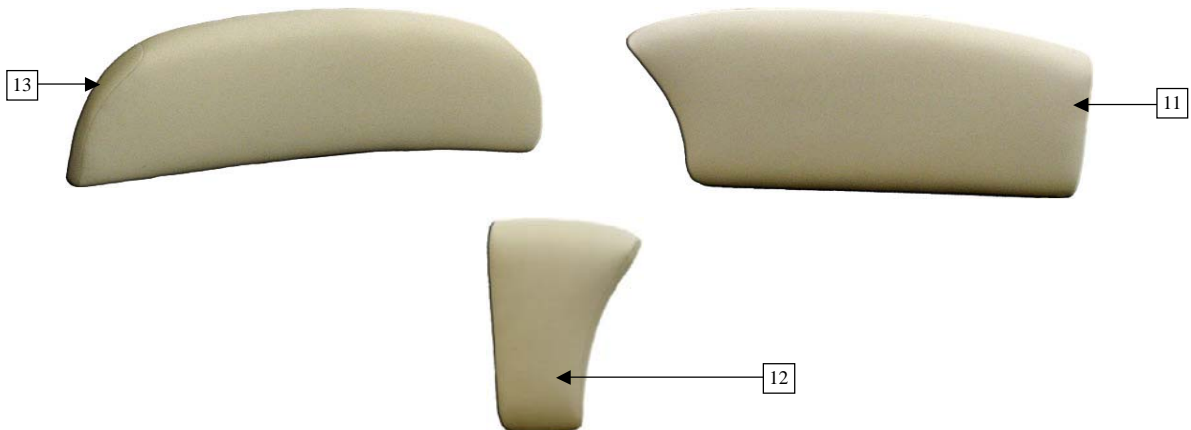

PARTS IDENTIFICATION GUIDE**SIGNATURE 310****2006 MODEL YEAR****Interiors - Forward Bow**

Item No.	Part Number	Description	Qty.	U.O.M
1	6.03003.910	310SIG V-BERTH STARBOARD PRIVACY CURTAIN SKIN NEUTRAL	1	EA
2	6.02938	310SIG STARBOARD SPEAKER BOX COMMON	1	EA
2a	6.02938.900	310SIG STARBOARD SPEAKER BOX SKIN	1	EA
3	6.02928	310SIG #3 BOW BACKREST COMMON	1	EA
3a	6.02928.900	310SIG #3 BOW BACKREST SKIN	1	EA
4	6.02929	310SIG #4 BOW BACKREST COMMON	1	EA
4a	6.02929.900	310SIG #4 BOW BACKREST SKIN	1	EA
5	6.02931	310SIG FORWARD BOW BUNK CUSHION COMMON	1	EA
5a	6.02931.910	310SIG FORWARD BOW BUNK CUSHION SKIN NEUTRAL	1	EA
6	510.6-S310-106C	FWD. BUNK STEP CABIN CARPET #6	1	EA
7	6.02939	310SIG V-BERTH RETAINER PAD COMMON	1	EA
7a	6.02939.910	310SIG V-BERTH RETAINER PAD SKIN NEUTRAL	1	EA
8	224923	PILLOW SET - 350/310 SIG BLACK (Option: Acc. Pkg-Black Cabin Interior)	1	SET
8a	224924	PILLOW SET - 350/310 SIG BLUE (Option: Acc. Pkg-Blue Cabin Interior)	1	SET
8b	224925	PILLOW SET - 350/310 SIG NEUTRAL (Option: Acc. Pkg-Neutral Cabin)	1	SET
8c	220073	350SIG STD PILLOWS 8 PCS. (Option: Acc. Pkg-Sand Optional Fabric)	1	SET
9	6.02937	310SIG PORT SPEAKER BOX COMMON	1	EA
9a	6.02937.900	310SIG PORT SPEAKER BOX SKIN	1	EA
10	6.02935	310SIG FORWARD BOW BULKHEAD MIRROR BOARD COMMON	1	EA
10a	6.02935.900	310SIG FORWARD BOW BULKHEAD MIRROR BOARD SKIN	1	EA
10b	6.02936	310SIG FORWARD BOW BULKHEAD MIRROR	1	EA
10c	6.02934	310SIG FORWARD BOW BULKHEAD BOARD	1	EA
11	6.02930	310SIG #5 BOW BACKREST COMMON	1	EA
11a	6.02930.900	310SIG #5 BOW BACKREST SKIN	1	EA
12	6.02926	310SIG #1 BOW BACKREST COMMON	1	EA
12a	6.02926.900	310SIG #1 BOW BACKREST SKIN	1	EA
13	6.02927	310SIG #2 BOW BACKREST COMMON	1	EA
13a	6.02927.900	310SIG #2 BOW BACKREST SKIN	1	EA

Parts Not Pictured Which Are Associated With Forward Bow Interior:

Not Pictured	6.02997.900	310SIG CABIN SNAP IN CARPET	1	EA
Not Pictured	6.03002.910	310SIG V-BERTH PORT PRIVACY CURTAIN SKIN NEUTRAL	1	EA
Not Pictured	6.03000.910	310SIG GALLEY CURTAIN SKIN NEUTRAL	2	EA
Not Pictured	6.03006.900	310SIG SHOWER CURTAIN SKIN	1	EA
Not Pictured	6.03007.900	310SIG HEAD WINDOW CURTAIN SKIN	2	EA
Not Pictured	510.6-S310-102C	MIDDLE CABIN ENTRY STEP CARPET #2	1	EA
Not Pictured	510.6-S310-103C	LOWER CABIN ENTRY STEP CARPET #3	1	EA
Not Pictured	510.6-S310-105C	MAIN SALON CABIN CARPET #5	1	EA
Not Pictured	510.6-S310-107C	UPPER CABIN ENTRY STEP CABIN CARPET #7	1	EA

NOTE: Numbers with letter designations represent parts included with primary numbered part for which there is no photo representation.

To order a complete part, you must order the common part as well as the skin.

Neutral cabin part numbers listed above. For other color options, replace the .910 with one of the numbers listed below:

- .910 - Neutral Fabric**
- .920 - Black Fabric**
- .940 - Blue Fabric**
- .970 - Sand Vinyl**

PARTS IDENTIFICATION GUIDE
SIGNATURE 310
2006 MODEL YEAR

Interiors - Dinette

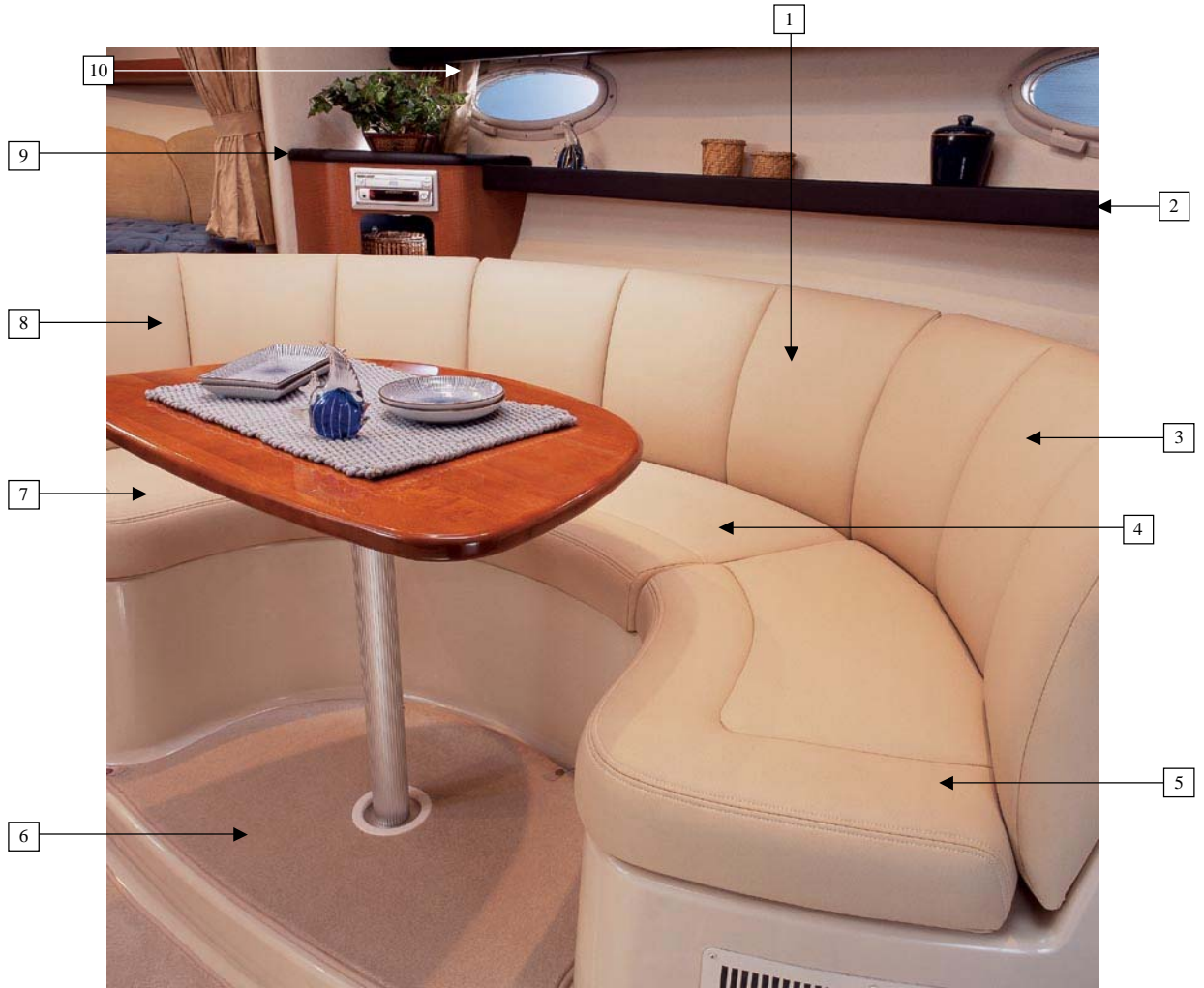

PARTS IDENTIFICATION GUIDE**SIGNATURE 310****2006 MODEL YEAR****Interiors - Dinette**

Item No.	Part Number	Description	Qty.	U.O.M
1	6.02942	310SIG CENTER DINETTE BACKREST COMMON	1	EA
1a	6.02942.900	310SIG CENTER DINETTE BACKREST SKIN	1	EA
2	6.03156	310SIG DINETTE SHELF PAD COMMON	1	EA
2a	6.03156.900	310SIG DINETTE SHELF PAD SKIN	1	EA
3	6.02943	310SIG REAR DINETTE BACKREST COMMON	1	EA
3a	6.02943.900	310SIG REAR DINETTE BACKREST SKIN	1	EA
4	6.02945	310SIG CENTER DINETTE CUSHION COMMON	1	EA
4a	6.02945.900	310SIG CENTER DINETTE CUSHION SKIN	1	EA
5	6.02946	310SIG REAR DINETTE CUSHION COMMON	1	EA
5a	6.02946.900	310SIG REAR DINETTE CUSHION SKIN	1	EA
6	510.6-S310-101C	DINETTE CABIN CARPET #1	1	EA
7	6.02944	310SIG FORWARD DINETTE CUSHION COMMON	1	EA
7a	6.02944.900	310SIG FORWARD DINETTE CUSHION SKIN	1	EA
8	6.02941	310SIG FORWARD DINETTE BACKREST COMMON	1	EA
8a	6.02941.900	310SIG FORWARD DINETTE BACKREST SKIN	1	EA
9	6.03154	310SIG DVD CABINET C-RAIL PAD COMMON	1	EA
9a	6.03154.900	310SIG DVD CABINET C-RAIL PAD SKIN	1	EA
10	6.02999.910	310SIG DINETTE CURTAIN SKIN NEUTRAL	2	EA
11	6.02947	310SIG DINETTE FILLER CUSHION COMMON	1	EA
11a	6.02947.900	310SIG DINETTE FILLER CUSHION SKIN	1	EA

Parts Not Pictured Which Are Associated With Dinette:

Not Pictured	6.03153	310SIG DINETTE TABLE COVER	1	EA
Not Pictured	6.02940	310SIG DINETTE SEATING ASSEMBLY COMMON	1	EA
Not Pictured	6.02940.900	310SIG DINETTE SEATING ASSEMBLY SKIN	1	EA

NOTE: Numbers with letter designations represent parts included with primary numbered part for which there is no photo representation.

To order a complete part, you must order the common part as well as the skin.

PARTS IDENTIFICATION GUIDE

SIGNATURE 310
2006 MODEL YEAR

Interiors - Aft Cabin

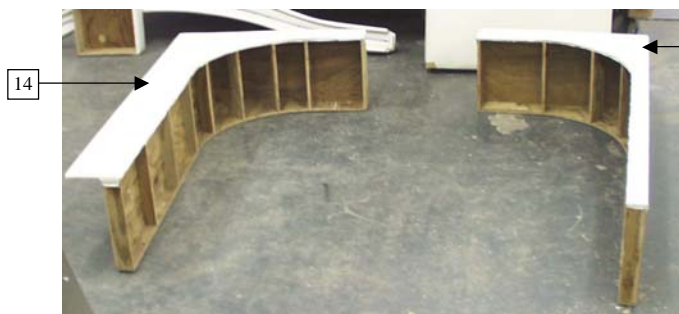

PARTS IDENTIFICATION GUIDE**SIGNATURE 310****2006 MODEL YEAR****Interiors - Aft Cabin**

Item No.	Part Number	Description	Qty.	U.O.M
1	6.02960	310SIG STARBOARD AFT CABIN BACKREST COMMON	1	EA
1a	6.02960.900	310SIG STARBOARD AFT CABIN BACKREST SKIN	1	EA
2	6.02961	310SIG CENTER AFT CABIN BACKREST COMMON	1	EA
2a	6.02961.900	310SIG CENTER AFT CABIN BACKREST SKIN	1	EA
3	6.02964	310SIG CENTER AFT CABIN CUSHION COMMON	1	EA
3a	6.02964.900	310SIG CENTER AFT CABIN CUSHION SKIN	1	EA
4	6.02968	310SIG PORT AFT CABIN FILLER CUSHION COMMON	1	EA
4a	6.02968.900	310SIG PORT AFT CABIN FILLER CUSHION SKIN	1	EA
5	6.02967	310SIG MIDDLE AFT CABIN FILLER CUSHION COMMON	1	EA
5a	6.02967.900	310SIG MIDDLE AFT CABIN FILLER CUSHION SKIN	1	EA
6	6.02966	310SIG STARBOARD AFT CABIN FILLER CUSHION COMMON	1	EA
6a	6.02966.900	310SIG STARBOARD AFT CABIN FILLER CUSHION SKIN	1	EA
7	6.02962	310SIG PORT AFT CABIN BACKREST COMMON	1	EA
7a	6.02962.900	310SIG PORT AFT CABIN BACKREST SKIN	1	EA
8	6.02965	310SIG PORT AFT CABIN CUSHION COMMON	1	EA
8a	6.02965.900	310SIG PORT AFT CABIN CUSHION SKIN	1	EA
9	510.6-S310-104C	AFT CABIN CARPET #4	1	EA
10	6.02963	310SIG STARBOARD AFT CABIN CUSHION COMMON	1	EA
10a	6.02963.900	310SIG STARBOARD AFT CABIN CUSHION SKIN	1	EA
11	6.03001.910	310SIG AFT BERTH CURTAIN SKIN NEUTRAL	2	EA
12	6.02969	310SIG AFT CABIN SHADOW BOX COMMON	1	EA
12a	6.02969.900	310SIG AFT CABIN SHADOW BOX SKIN	1	EA
13	6.02958	310SIG CENTER AFT CABIN BASE COMMON	1	EA
13a	6.02958.900	310SIG CENTER AFT CABIN BASE SKIN	1	EA
14	6.02957	310SIG STARBOARD AFT CABIN BASE COMMON	1	EA
14a	6.02957.900	310SIG STARBOARD AFT CABIN BASE SKIN	1	EA
15	6.02959	310SIG PORT AFT CABIN BASE COMMON	1	EA
15a	6.02959.900	310SIG PORT AFT CABIN BASE SKIN	1	EA

Parts Not Pictured Which Are Associated With Aft Cabin:

Not Pictured	6.03004.910	310SIG AFT BERTH PRIVACY CURTAIN SKIN NEUTRAL	1	EA
Not Pictured	6.03005.910	310SIG AFT BERTH LOWER PRIVACY CURTAIN SKIN NEUTRAL	1	EA

NOTE: Numbers with letter designations represent parts included with primary numbered part for which there is no photo representation.

To order a complete part, you must order the common part as well as the skin.

PARTS IDENTIFICATION GUIDE

SIGNATURE 310

2006 MODEL YEAR

Interiors - Headliner Boards

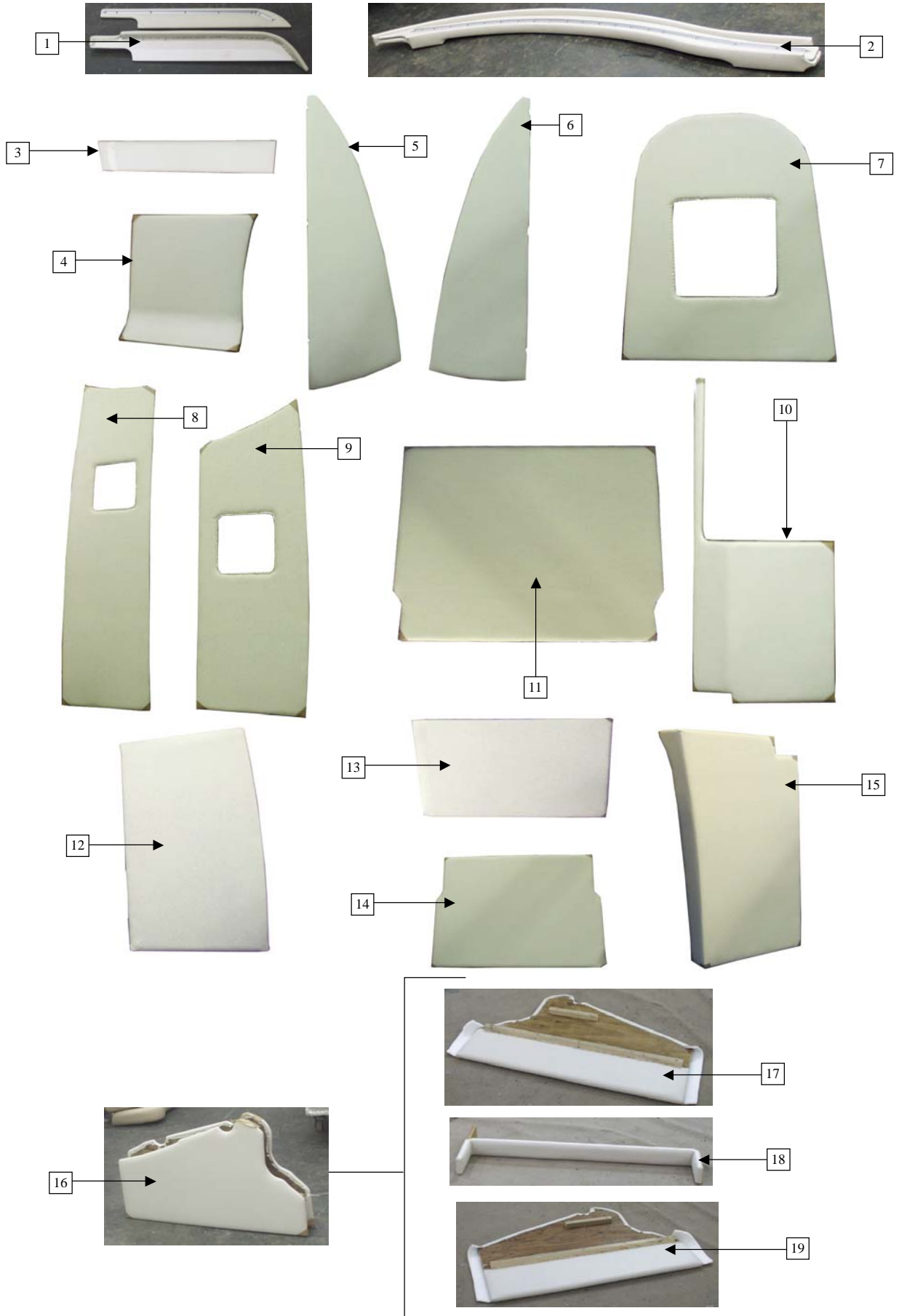

PARTS IDENTIFICATION GUIDE**SIGNATURE 310****2006 MODEL YEAR****Interiors - Headliner Boards**

Item No.	Part Number	Description	Qty.	U.O.M
1	6.02970	310SIG AFT CABIN CURTAIN TRACK COMMON	1	EA
1a	6.02970.900	310SIG AFT CABIN CURTAIN TRACK SKIN	1	EA
2	6.02973	310SIG V-BERTH CURTAIN TRACK COMMON	1	EA
2a	6.02973.900	310SIG V-BERTH CURTAIN TRACK SKIN	1	EA
3	6.02975	310SIG AFT HEAD CLOSE OUT PANEL COMMON	1	EA
3a	6.02975.900	310SIG AFT HEAD CLOSE OUT PANEL SKIN	1	EA
4	6.02988	310SIG STARBOARD ENTRY WAY CEILING PAD COMMON	1	EA
4a	6.02988.900	310SIG STARBOARD ENTRY WAY CEILING PAD SKIN	1	EA
5	6.02984	310SIG PORT FORWARD CEILING PAD COMMON	1	EA
5a	6.02984.900	310SIG PORT FORWARD CEILING PAD SKIN	1	EA
6	6.02985	310SIG STARBOARD FORWARD CEILING PAD COMMON	1	EA
6a	6.02985.900	310SIG STARBOARD FORWARD CEILING PAD SKIN	1	EA
7	6.02990	310SIG FORWARD CEILING PAD COMMON	1	EA
7a	6.02990.900	310SIG FORWARD CEILING PAD SKIN	1	EA
8	6.02986	310SIG STARBOARD AFT CEILING PAD COMMON	1	EA
8a	6.02986.900	310SIG STARBOARD AFT CEILING PAD SKIN	1	EA
9	6.02987	310SIG PORT AFT CEILING PAD COMMON	1	EA
9a	6.02987.900	310SIG PORT AFT CEILING PAD SKIN	1	EA
10	6.02992	310SIG AFT CABIN ENTRY WALL COMMON	1	EA
10a	6.02992.900	310SIG AFT CABIN ENTRY WALL SKIN	1	EA
11	6.02991	310SIG CENTER CEILING PAD COMMON	1	EA
11a	6.02991.900	310SIG CENTER CEILING PAD SKIN	1	EA
12	6.02993	310SIG AFT CABIN CENTER CEILING PAD COMMON	1	EA
12a	6.02993.900	310SIG AFT CABIN CENTER CEILING PAD SKIN	1	EA
13	6.02994	310SIG AFT CABIN STARBOARD CEILING PAD COMMON	1	EA
13a	6.02994.900	310SIG AFT CABIN STARBOARD CEILING PAD SKIN	1	EA
14	6.02989	310SIG ENTRY WAY CEILING PAD COMMON	1	EA
14a	6.02989.900	310SIG ENTRY WAY CEILING PAD SKIN	1	EA
15	6.02995	310SIG AFT CABIN PORT CEILING PAD COMMON	1	EA
15a	6.02995.900	310SIG AFT CABIN PORT CEILING PAD SKIN	1	EA
16	6.02951	310SIG CURTAIN BULKHEAD ASSEMBLY COMMON	1	EA
16a	6.02951.900	310SIG CURTAIN BULKHEAD ASSEMBLY SKIN	1	EA
16b	6.02955	310SIG CURTAIN BULKHEAD SPACER COMMON	1	EA
17	6.02952	310SIG FORWARD CURTAIN BULKHEAD COMMON	1	EA
17a	6.02952.900	310SIG FORWARD CURTAIN BULKHEAD SKIN	1	EA
18	6.02954	310SIG CURTAIN BULKHEAD INSERT COMMON	1	EA
18a	6.02954.900	310SIG CURTAIN BULKHEAD INSERT SKIN	1	EA
19	6.02953	310SIG AFT CURTAIN BULKHEAD COMMON	1	EA
19a	6.02953.900	310SIG AFT CURTAIN BULKHEAD SKIN	1	EA

Parts Not Pictured Which Are Associated With Headliner Boards:

Not Pictured	6.02971	310SIG AFT CABIN CURTAIN TRACK INSERT COMMON	1	EA
Not Pictured	6.02971.900	310SIG AFT CABIN CURTAIN TRACK INSERT SKIN	1	EA
Not Pictured	6.02974	310SIG V-BERTH CURTAIN TRACK INSERT COMMON	1	EA
Not Pictured	6.02974.900	310SIG V-BERTH CURTAIN TRACK INSERT SKIN	1	EA
Not Pictured	6.02972	310SIG AFT CABIN LOWER CURTAIN TRACK	1	EA

NOTE: Numbers with letter designations represent parts included with primary numbered part for which there is no photo representation.

To order a complete part, you must order the common part as well as the skin.

PARTS IDENTIFICATION GUIDE
SIGNATURE 310
2006 MODEL YEAR

Interiors - Carpet Boards

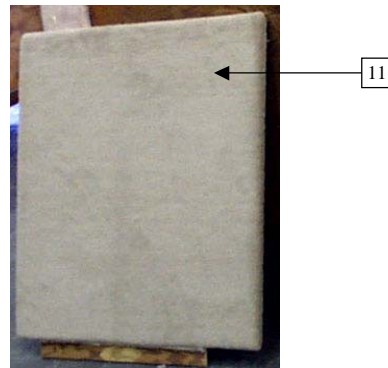
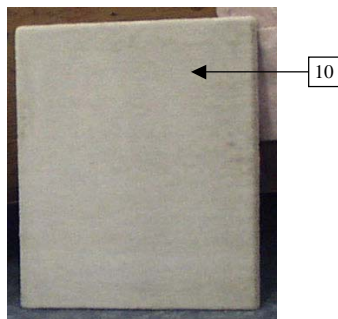
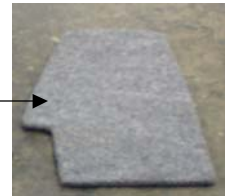
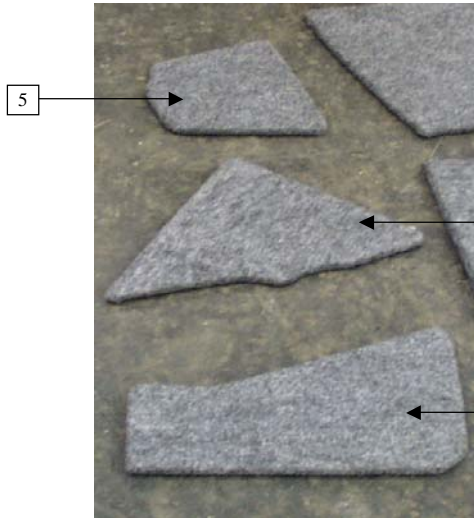
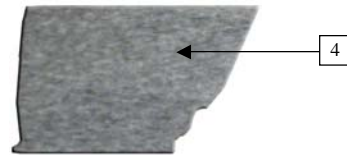
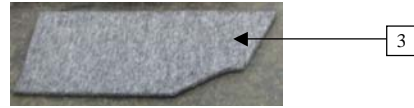
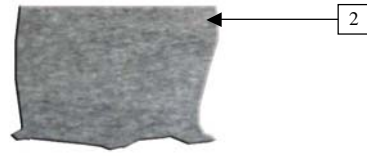
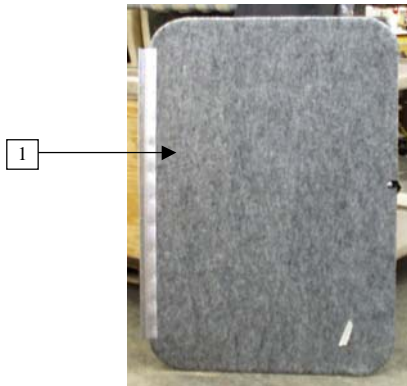

PARTS IDENTIFICATION GUIDE
SIGNATURE 310
2006 MODEL YEAR

Interiors - Carpet Boards

Item No.	Part Number	Description	Qty.	U.O.M
1	6.02932	310SIG FORWARD V-BERTH HATCH COMMON	1	EA
1a	6.02932.900	310SIG FORWARD V-BERTH HATCH SKIN	1	EA
2	6.02948	310SIG AFT DINETTE CLOSE OUT BOARD COMMON	1	EA
2a	6.02948.900	310SIG AFT DINETTE CLOSE OUT BOARD SKIN	1	EA
3	6.02949	310SIG BOW DINETTE CLOSE OUT BOARD COMMON	1	EA
3a	6.02949.900	310SIG BOW DINETTE CLOSE OUT BOARD SKIN	1	EA
4	6.02950	310SIG CENTER DINETTE CLOSE OUT BOARD COMMON	1	EA
4a	6.02950.900	310SIG CENTER DINETTE CLOSE OUT BOARD SKIN	1	EA
5	6.02977	310SIG AFT BERTH LOCKER STARBOARD REAR CLOSE OUT COMMON	1	EA
5a	6.02977.900	310SIG AFT BERTH LOCKER STARBOARD REAR CLOSE OUT SKIN	1	EA
6	6.03022	310SIG V-BERTH LOCKER CLOSE OUT COMMON	1	EA
6a	6.03022.900	310SIG V-BERTH LOCKER CLOSE OUT SKIN	1	EA
7	6.02976	310SIG AFT BERTH LOCKER STARBOARD FORWARD CLOSE OUT COMMON	1	EA
7a	6.02976.900	310SIG AFT BERTH LOCKER STARBOARD FORWARD CLOSE OUT SKIN	1	EA
8	6.02978	310SIG AFT BERTH LOCKER PORT REAR CLOSE OUT COMMON	1	EA
8a	6.02978.900	310SIG AFT BERTH LOCKER PORT REAR CLOSE OUT SKIN	1	EA
9	6.02979	310SIG AFT BERTH LOCKER PORT CLOSE OUT COMMON	1	EA
9a	6.02979.900	310SIG AFT BERTH LOCKER PORT CLOSE OUT SKIN	1	EA
10	6.02923	310SIG STARBOARD AFT STORAGE PULL OUT STORAGE BOARD COMMON	1	EA
10a	6.02923.900	310SIG STARBOARD AFT STORAGE PULL OUT STORAGE BOARD SKIN	1	EA
11	6.02924	310SIG PORT AFT STORAGE PULL OUT STORAGE BOARD COMMON	1	EA
11a	6.02924.900	310SIG PORT AFT STORAGE PULL OUT STORAGE BOARD SKIN	1	EA

NOTE: Numbers with letter designations represent parts included with primary numbered part for which there is no photo representation.

To order a complete part, you must order the common part as well as the skin.

PARTS IDENTIFICATION GUIDE

SIGNATURE 310

2006 MODEL YEAR

Go Back

Alternating Current Electrical System

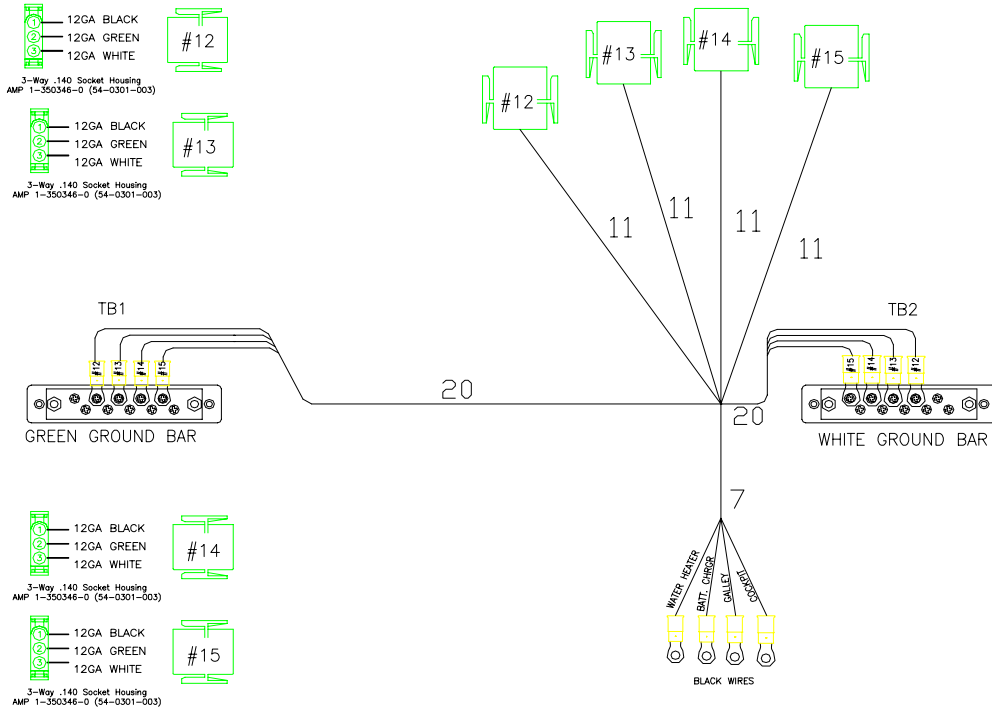

ATTACH ALL GREEN WIRES FROM EACH LAYOUT TO THE SAME GROUND BAR
ATTACH ALL WHITE WIRES FROM EACH LAYOUT TO THE SAME GROUND BAR

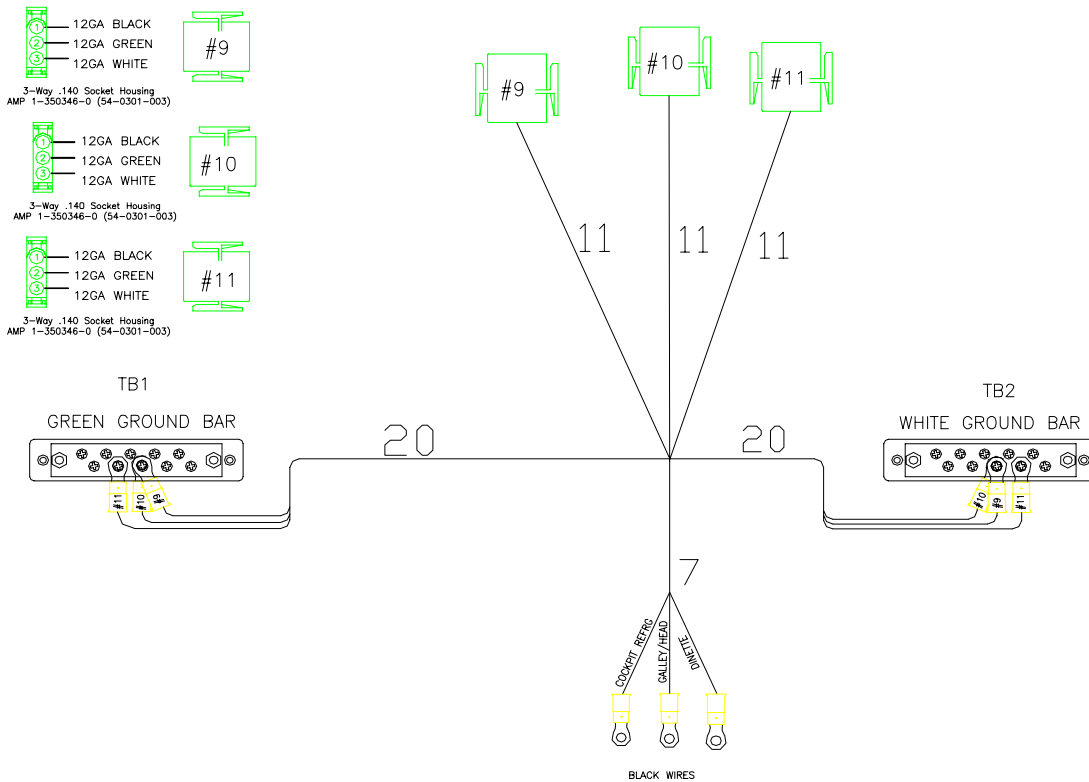

ATTACH ALL GREEN WIRES FROM EACH LAYOUT TO THE SAME GROUND BAR
ATTACH ALL WHITE WIRES FROM EACH LAYOUT TO THE SAME GROUND BAR

PARTS IDENTIFICATION GUIDE**SIGNATURE 310****2006 MODEL YEAR****Alternating Current Electrical System**

Part Number	Description	Qty.	U.O.M.
120 Volt AC Kit:			
203-00041-A	68" OUT BOX - WHT DECORA WITH WHT CVR (Galley Refrig)	1	EA
203-00042-A	S310 78IN STOVE CABLE	1	EA
203-00043-A	24" OUT BOX - BLK DECORA WITH BLK CVR (Microwave)	1	EA
203-00044-A	36" OUT BOX - WHT DECORA WITH WHT CVR (Coffee Maker)	1	EA
203-00045-A	58" OUT BOX - BLK DECORA WITH BLK CVR (TV)	1	EA
203-00046-A	12" OUT BOX - WHT DECORA W/ WATER PROOF CVR (Head)	1	EA
203-00116-A	AC CABLE ASSEMBLY	1	EA
203-00119-A	12" OUT BOX - WHT GFCI WITH WHT W/P CVR (Cockpit Outlet)	1	EA
203-00470-A	GRAY DECORA ASSY 2 12" PIGS (Dinette)	1	EA
203-00472-A	OUTLET 12IN GRA DECORA W/ SHALLOW BOX (Playstation)	1	EA
203-00475-A	OUTLET BOX 58IN & 40IN GRA GFCI (DBL CBL) W/SS DECORA CVR (Galley)	1	EA
204-00040-A	AC SHORE INLET BRKR ASSY SIG	1	EA
204-00042-A	SWITCH 310 SIG SW ASSEMBLY GRY SHALLOW BOX F. CAB LT	1	EA
204-00043-A	SWITCH 310 SIG ASSY GRY DEEP BOX, DINN, A. CAB, GALLEY	1	EA
205-00023-A	GALLEY CIRCUIT BREAKER PANEL S310	1	EA
205-00022-F	WIRING - 120V AC PANEL 310SIG	1	EA
700-8440140	SWITCH STAINLESS STEEL DECORATIVE COVER (Playstation)	1	EA

220 Volt AC Kit Option:

203-00041	S310 68IN OUT BOX-WHT DEC	1	EA
203-00116	S310 AC CABLE ASSEMBLY	1	EA
203-00164	36IN OUT BX ASSY (Coffee Maker)	1	EA
203-00165	58IN OUT BOX ASSY (TV)	1	EA
203-00166	58IN & 40IN OUT BX-BLK (DBL CBL) (Galley)	1	EA
203-00167	12IN OUT BOX ASSY (Dinette)	1	EA
203-00168	12IN OUT BOX ASSY W/ W/P CVR (Cockpit)	1	EA
203-00169	24IN OUT BOX ASSY (Microwave)	1	EA
203-00170	12IN OUT BOX W/ W/P CVR (Head)	1	EA
203-00313-A	OUTLET - 220V VIMAR 1-60IN , 1-12IN PIG S270	1	EA
204-00020	OUTLET - 220V VIMAR W/ SHALLOW BOX	1	EA
204-00040-A	AC SHORE INLET BRKR ASSY	1	EA
205-00024	S310 220V AC PANEL	1	EA
220-03245-P	CHAP. EURO GFI BREAKER PANEL	1	EA

PARTS IDENTIFICATION GUIDE

SIGNATURE 310

2006 MODEL YEAR

Alternating Current Electrical System

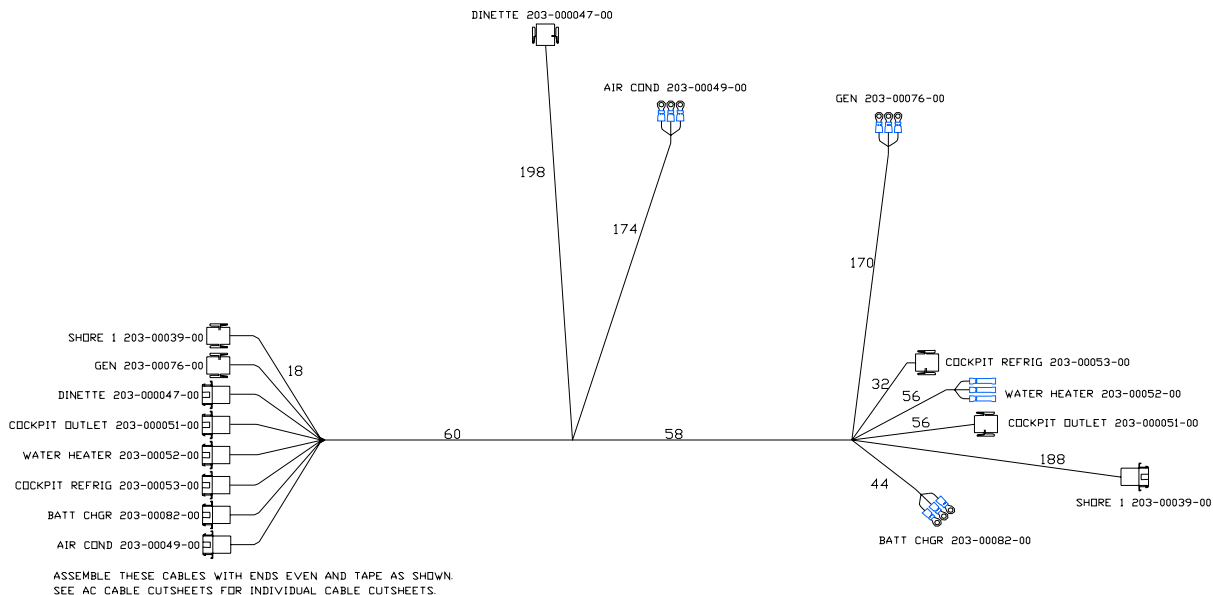

FACEPLATE 200-00015

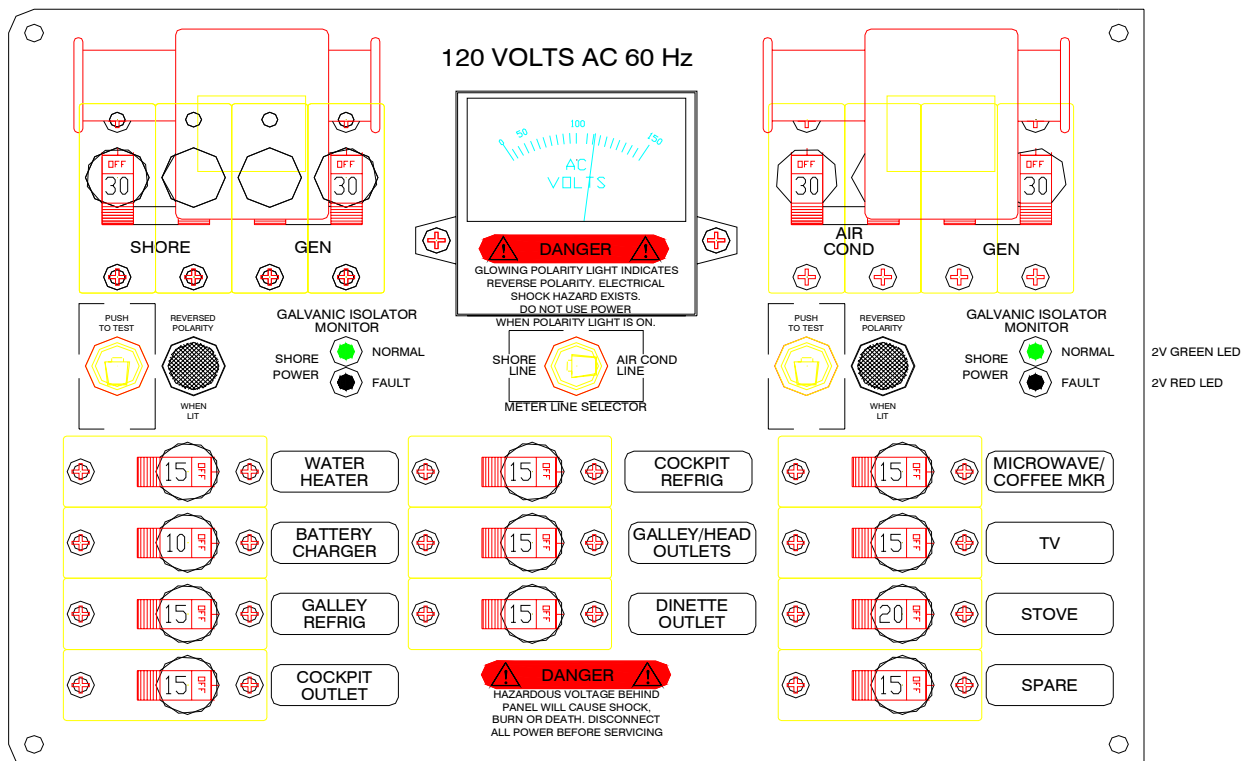

PARTS IDENTIFICATION GUIDE

SIGNATURE 310

2006 MODEL YEAR

Go Back

Alternating Current Electrical System

